



The Sipwise C5 CE Handbook mr7.5.1

Sipwise GmbH
<support@sipwise.com>

Contents

1	Introduction	1
1.1	About this Handbook	1
1.2	What is the Sipwise C5 CE?	1
1.3	The Advantages of the Sipwise C5 CE	1
1.4	Who is the Sipwise C5 CE for?	2
1.5	Getting Help	2
1.5.1	Community Support	2
1.5.2	Commercial Support	2
2	Architecture	3
2.1	SIP Signaling and Media Relay	3
2.1.1	SIP Load-Balancer	4
2.1.2	SIP Proxy/Registrar	5
2.1.3	SIP Back-to-Back User-Agent (B2BUA)	5
2.1.4	SIP App-Server	6
2.1.5	Media Relay	7
2.2	Redis Database	7
3	Initial Installation	8
3.1	Prerequisites	8
3.2	Using Sipwise C5 install CD (recommended)	8
3.3	Using the Sipwise C5 installer	9
3.3.1	Installing the Operating System	9
3.3.2	Installing the Sipwise C5	10
3.4	Using a pre-installed virtual machine	11
3.4.1	Vagrant box for VirtualBox	11
3.4.2	VirtualBox image	14
3.4.3	VMware image	14

3.4.4	Amazon EC2 image	15
4	Initial System Configuration	20
4.1	Network Configuration	21
4.2	Apply Configuration Changes	23
4.3	Start Securing Your Server	23
4.4	Configuring the system-wide editor	23
4.5	Configuring the Email Server	24
4.6	Advanced Network Configuration	24
4.7	What's next?	24
5	VoIP Service Administration Concepts	25
5.1	Contacts	25
5.2	Resellers	25
5.3	SIP Domain	26
5.3.1	Additional SIP Domains	26
5.4	Contracts	27
5.5	Customers	27
5.5.1	Residential and SOHO customers	27
5.5.2	Business customers with the Cloud PBX service	28
5.5.3	SIP Trunking	29
5.5.4	Mobile subscribers	29
5.5.5	Pre-paid subscribers who use your calling cards	29
5.6	Subscribers	29
5.7	SIP Peerings	30
6	VoIP Service Configuration Scenario	32
6.1	Creating a SIP Domain	32
6.2	Creating a Customer	33
6.3	Creating a Subscriber	38

6.4	Domain Preferences	42
6.5	Subscriber Preferences	45
6.6	Creating Peerings	46
6.6.1	Creating Peering Groups	46
6.6.2	Creating Peering Servers	48
6.6.3	Authenticating and Registering against Peering Servers	60
6.7	Configuring Rewrite Rule Sets	62
6.7.1	Inbound Rewrite Rules for Caller	65
6.7.2	Inbound Rewrite Rules for Callee	67
6.7.3	Outbound Rewrite Rules for Caller	68
6.7.4	Outbound Rewrite Rules for Callee	69
6.7.5	Emergency Number Handling	69
6.7.6	Assigning Rewrite Rule Sets to Domains and Subscribers	71
6.7.7	Creating Dialplans for Peering Servers	72
6.7.8	Call Routing Verification	72
7	Features	78
7.1	About the Admin Web Interface	78
7.1.1	Filtering the Lists / Databases	78
7.1.2	Call History	79
7.2	Managing System Administrators	80
7.2.1	Configuring Administrators	80
7.2.2	Access Rights of Administrators	81
7.3	Access Control for SIP Calls	84
7.3.1	Block Lists	84
7.3.2	NCOS (Network Class of Service) Levels	86
7.3.3	IP Address Restriction	94
7.3.4	CLI-based Access Control	94
7.4	Call Forwarding and Call Hunting	95

7.4.1	Call Forward Types	95
7.4.2	Setting a simple Call Forward	96
7.4.3	Call Forward Destinations	96
7.4.4	Advanced Call Hunting	97
7.5	Local Number Porting	105
7.5.1	Local LNP Database	105
7.6	Emergency Mapping	109
7.6.1	Emergency Mapping Description	110
7.6.2	Emergency Mapping Configuration	110
7.7	Emergency Priorization	116
7.7.1	Call-Flow with Emergency Mode Enabled	117
7.7.2	Configuration of Emergency Mode	120
7.7.3	Activating Emergency Mode	121
7.8	SIP Message Filtering	122
7.8.1	Header Filtering	122
7.8.2	Codec Filtering	123
7.8.3	Enable History and Diversion Headers	124
7.8.4	User Agent Filtering	124
7.9	SIP Trunking with SIPconnect	125
7.9.1	User provisioning	125
7.9.2	Inbound calls routing	125
7.9.3	Number manipulations	125
7.9.4	Registration	128
7.10	Trusted Subscribers	129
7.11	Peer Probing	129
7.11.1	Introduction to Peer Probing Feature	129
7.11.2	Configuration of Peer Probing	130
7.11.3	Monitoring of Peer Probing	132

7.11.4 Further Details for Advanced Users	133
7.12 Voicemail System	133
7.12.1 Accessing the IVR Menu	133
7.12.2 IVR Menu Structure	134
7.12.3 Type Of Messages	136
7.12.4 Folders	136
7.12.5 Voicemail Languages Configuration	137
7.12.6 Flowcharts with Voice Prompts	137
7.13 Configuring Subscriber IVR Language	142
7.14 Sound Sets	142
7.14.1 Sound_Set and Contract_Sound_Set Usage	143
7.14.2 Configuring Early Reject Sound Sets	143
7.14.3 Play an announcement on behalf of callee server failure in case of outbound calls	149
7.15 Conference System	149
7.15.1 Configuring Call Forward to Conference	149
7.15.2 Configuring Conference Sound Sets	150
7.15.3 Joining the Conference	152
7.15.4 Conference Flowchart with Voice Prompts	152
7.16 Malicious Call Identification (MCID)	154
7.16.1 Setup	154
7.16.2 Usage	155
7.16.3 Advanced configuration	155
7.17 Subscriber Profiles	155
7.17.1 Subscriber Profile Sets	155
7.18 SIP Loop Detection	158
7.19 Invoices and Invoice Templates	158
7.19.1 Invoices Management	158
7.19.2 Invoice Management via REST API	160

7.19.3 Invoice Templates	165
7.20 Email Reports and Notifications	175
7.20.1 Email events	175
7.20.2 Initial template values and template variables	175
7.20.3 Password reset email template	175
7.20.4 New subscriber notification email template	176
7.20.5 Invoice email template	176
7.20.6 Email templates management	178
7.21 The Vertical Service Code Interface	180
7.21.1 Configuration of Vertical Service Codes	180
7.21.2 Voice Prompts for Vertical Service Code Configuration	181
7.22 Handling WebRTC Clients	182
7.23 XMPP and Instant Messaging	183
7.24 Call Recording	183
7.24.1 Introduction to Call Recording Function	183
7.24.2 Information on Files and Directories	184
7.24.3 Configuration	184
7.24.4 REST API	189
7.24.5 Pre-Recording Announcement	190
7.25 Media Transcoding	190
7.25.1 Overview	190
7.25.2 Supported Codecs	190
7.25.3 Configuration	191
7.26 Announcement Before Call Setup	193
7.27 SMS (Short Message Service) on Sipwise C5	194
7.27.1 Configuration	196
7.27.2 Monitoring, troubleshooting	197
7.27.3 REST API	204

7.28 Time sets management	205
7.28.1 Time sets specifications and data description	205
7.28.2 Web interface for the time sets	206
7.28.3 Web interface for the time set events	208
7.28.4 Web interface for time set related to reseller	216
7.28.5 REST API	217
8 Customer Self-Care Interface and Menus	219
8.1 The Customer Self-Care Web Interface	219
8.1.1 Login Procedure	219
8.1.2 Site Customization	219
8.2 The Voicemail Menu	225
9 Billing Configuration	226
9.1 Billing Profiles	226
9.1.1 Creating Billing Profiles	226
9.1.2 Creating Billing Fees	228
9.1.3 Creating Off-Peak Times	231
9.2 Fraud Detection and Locking	233
9.2.1 Fraud Lock Levels	234
9.3 Notes on Billing and Call Rating	234
9.4 Billing Data Export	235
9.4.1 Glossary of Terms	235
9.4.2 File Name Format	236
9.4.3 File Format	236
9.4.4 File Transfer	249
10 Provisioning REST API Interface	250
10.1 API Workflows for Customer and Subscriber Management	250
10.2 API performance considerations	255

11 Configuration Framework	256
11.1 Configuration templates	256
11.1.1 .tt2, .customtt.tt2 and .patchtt.tt2 files	256
11.1.2 Using patchtt for generation of a relevant customtt file	259
11.1.3 .prebuild and .postbuild files	260
11.1.4 .services files	261
11.2 config.yml, constants.yml and network.yml files	262
11.3 ngcpcfg and its command line options	262
11.3.1 apply	262
11.3.2 build	262
11.3.3 commit	263
11.3.4 decrypt	263
11.3.5 diff	263
11.3.6 encrypt	263
11.3.7 help	263
11.3.8 initialise	263
11.3.9 pull	263
11.3.10push	264
11.3.11services	264
11.3.12status	264
12 Network Configuration	265
12.1 General Structure	265
12.1.1 Available Host Options	265
12.1.2 Interface Parameters	266
12.2 Advanced Network Configuration	267
12.2.1 Additional entries in <code>/etc/hosts</code>	267
12.2.2 Extra SIP Sockets	269
12.2.3 Extra SIP and RTP Sockets	269

12.2.4	Alternative RTP Interface Selection Using ICE	271
12.2.5	Extended RTP Port Range Using Multiple Interfaces	272
13	Licenses	273
14	Software Upgrade	274
14.1	Release Notes	274
14.2	Overview	274
14.3	Preparing the software upgrade	274
14.3.1	Log into the C5 server	275
14.3.2	Check the overall system status	275
14.3.3	Evaluate and update custom modifications	275
14.3.4	Check system integrity	276
14.3.5	Check the configuration framework status	277
14.3.6	Check migration of location entries from Mysql to Redis DB	277
14.4	Upgrade from previous versions to mr7.5.1	278
14.4.1	Preparing for maintenance mode	278
14.4.2	Set the proper software repositories	279
14.4.3	Switch to new repositories	280
14.4.4	Upgrade Sipwise C5	280
14.4.5	ngcp-upgrade options	281
14.5	Post-upgrade tasks	281
14.5.1	Disabling maintenance mode	281
14.5.2	Post-upgrade checks	282
14.6	Applying the Latest Hotfixes	282
14.6.1	Apply hotfixes	282
14.6.2	Recheck or update the custom configuration templates	282
15	Backup, Recovery and Database Maintenance	283
15.1	Sipwise C5 Backup	283

15.1.1 What data to back up	283
15.2 Recovery	283
15.3 Reset Database	284
15.4 Accounting Data (CDR) Cleanup	284
15.4.1 Cleanuptools Configuration	284
15.4.2 Accounting Database Cleanup	284
15.4.3 Exported CDR Cleanup	287
16 Platform Security, Performance and Troubleshooting	289
16.1 Sipwise SSH access to Sipwise C5	289
16.2 Firewalling	290
16.2.1 Firewall framework	290
16.2.2 Sipwise C5 firewall configuration	291
16.2.3 IPv4 System rules	292
16.2.4 Custom rules	295
16.2.5 Example firewall configuration section	296
16.3 Password management	296
16.3.1 The "root" account	296
16.3.2 The "administrator" account	297
16.3.3 The "cdlexport" account	297
16.3.4 The MySQL "root" user	297
16.3.5 The "ngcpsoap" account	297
16.4 Remote <i>root</i> logins via SSH	298
16.5 <i>sudo-io</i> : logging input/output of commands run through <i>sudo</i>	298
16.6 SSL certificates	299
16.7 Securing your Sipwise C5 against SIP attacks	300
16.7.1 Denial of Service	300
16.7.2 Bruteforcing SIP credentials	301
16.8 Topology Hiding	302

16.8.1	Introduction to Topology Hiding on NGCP	302
16.8.2	Topology Masking Mechanism	302
16.8.3	Topology Hiding Mechanism	304
16.9	System Requirements and Performance	304
16.10	Troubleshooting	307
16.10.1	Collecting call information from logs	309
16.10.2	Collecting SIP traces	309
17	Monitoring and Alerting	311
17.1	Internal Monitoring	311
17.1.1	System monitoring via Telegraf	311
17.1.2	Sipwise C5 specific monitoring via ngcp-witnessd	311
17.1.3	Monitoring data in InfluxDB	311
17.2	Statistics Dashboard	312
18	MariaDB encryption	313
18.1	Overview	313
18.2	Configuration	313
18.3	What is not encrypted	313
A	Basic Call Flows	315
A.1	General Call Setup	315
A.2	Endpoint Registration	316
A.3	Basic Call	319
A.4	Session Keep-Alive	320
A.5	Voicebox Calls	321
B	Sipwise C5 configs overview	323
B.1	config.yml Overview	323
B.1.1	apps	323
B.1.2	asterisk	323

B.1.3 autoprov	324
B.1.4 backuptools	325
B.1.5 cdlexport	326
B.1.6 cleanuptools	327
B.1.7 cluster_sets	328
B.1.8 database	328
B.1.9 faxserver	329
B.1.10 general	329
B.1.11 heartbeat	330
B.1.12 intercept	330
B.1.13 kamailio	330
B.1.14 ngcp-mediator	344
B.1.15 modules	344
B.1.16 monitoring	345
B.1.17 nginx	346
B.1.18 ntp	346
B.1.19 ossbss	346
B.1.20 pbx (only with additional cloud PBX module installed)	348
B.1.21 prosody	348
B.1.22 pushd	349
B.1.23 qos	351
B.1.24 ngcp-rate-o-mat	352
B.1.25 redis	352
B.1.26 reminder	352
B.1.27 rsyslog	353
B.1.28 rtpproxy	353
B.1.29 security	356
B.1.30 sems	357

B.1.31 sms	358
B.1.32 snmpd	360
B.1.33 snmptrapd	361
B.1.34 snmpagent	361
B.1.35 sshd	361
B.1.36 sudo	362
B.1.37 telegraf	362
B.1.38 ngcp-witnessd	362
B.1.39 www_admin	364
B.2 constants.yml Overview	366
B.3 network.yml Overview	367
C NGCP Internals	369
C.1 Pending reboot marker	369
C.2 Redis id constants	369
C.2.1 InfluxDB monitoring keys	370
C.3 Enum preferences	371
D New kamailio pv_headers module	373
D.1 Module overview	373
D.2 Template changes	373
D.3 Module documentation	374
D.3.1 Parameters	374
D.3.2 Functions	375
D.3.3 Pseudovariables	378
E Extra Configuration Scenarios	383
E.1 AudioCodes devices workaround	383

1 Introduction

1.1 About this Handbook

This handbook describes the architecture and the operational steps to install, operate and modify the Sipwise C5 CE.

In various chapters, it describes the system architecture, the installation and upgrade procedures and the initial configuration steps to get your first users online. It then dives into advanced preference configurations such as rewrite rules, call blocking, call forwarding, etc.

There is a description of the customer self-care interface, how to configure the billing system and how to provision the system via the API.

Finally, it describes the internal configuration framework, the network configuration and gives hints about tweaking the system for better security and performance.

1.2 What is the Sipwise C5 CE?

Sipwise C5 (also known as NGCP - the Next Generation Communication Platform) is a SIP-based Open Source Class 5 VoIP soft-switch platform that allows you to provide rich telephony services. It offers a wide range of features (e.g. call forwarding, voicemail, conferencing etc.) that can be configured by end users in the self-care web interface. For operators, it offers a web-based administrative panel that allows them to configure subscribers, SIP peerings, billing profiles, and other entities. The administrative web panel also shows the real-time statistics for the whole system. For tight integration into existing infrastructures, Sipwise C5 provides a powerful REST API interface.

Sipwise C5 has three solutions that differ in call capacity and service redundancy: CARRIER, PRO and CE. The current handbook describes the CE solution.

The Sipwise C5 CE can be installed in a few steps within a couple of minutes and requires no knowledge about configuration files of specific software components.

1.3 The Advantages of the Sipwise C5 CE

Opposed to other free VoIP software, Sipwise C5 is not a single application, but a complete software platform based on Debian GNU/Linux.

Using a highly modular design approach, Sipwise C5 leverages popular open-source software like MySQL, NGINX, Kamailio, SEMS, Asterisk, etc. as its core building blocks. These blocks are glued together using optimized and proven configurations and workflows and are complemented by functionality developed by Sipwise to provide fully-featured and easy-to-operate VoIP services.

After downloading and starting the installer, it will fetch and install all the required Debian packages from the relevant Debian repositories. The installed applications are managed by the Sipwise C5 Configuration Framework. This configuration framework makes it possible to change low-level system parameters in a single place, so Sipwise C5 administrators don't need to have any knowledge of dozens of different configuration files from different packages. This provides a very easy and bullet-proof way of

operating, changing and tweaking an otherwise quite complex system.

Once configured, integrated web interfaces are provided for both end users and Sipwise C5 administrators. Provisioning and billing API allows companies to tightly integrate Sipwise C5 into existing OSS/BSS infrastructures to optimize workflows.

1.4 Who is the Sipwise C5 CE for?

The Sipwise C5 CE is specifically tailored to companies and engineers trying to start or experiment with a fully-featured SIP-based VoIP service without having to go through the steep learning curve of SIP signalling. It integrates the different building blocks to make them work together in a reasonable way and implements the missing components to build a business on top of that.

In the past, creating a business-ready VoIP service included installation and configuration of SIP software like Asterisk, OpenSER, Kamailio, etc., which can get quite difficult when it comes to implementing advanced features. It required implementing different web interfaces, billing engines and connectors to existing OSS/BSS infrastructure. These things are now obsolete due to the Sipwise C5 CE, which covers all these requirements.

1.5 Getting Help

1.5.1 Community Support

We have set up the [spce-user](#) mailing list, where questions are answered on a best-effort basis and discussions can be started with other community users.

1.5.2 Commercial Support

If you need professional help setting up and maintaining the Sipwise C5 CE, send an email to sales@sipwise.com.

Sipwise also provides training and commercial support for the platform. Additionally, we offer a migration path to the Sipwise C5 PRO or CARRIER appliance, which is the commercial, carrier-grade version of the Sipwise C5 CE. If the user base grows on the Sipwise C5 CE, this will allow operators to migrate seamlessly to a highly available and scalable platform with defined service level agreements, phone support and on-call duty. Please visit www.sipwise.com for more information on commercial offerings.

2 Architecture

The Sipwise C5 platform is one single node running all necessary components of the system. The components are outlined in the following figure:

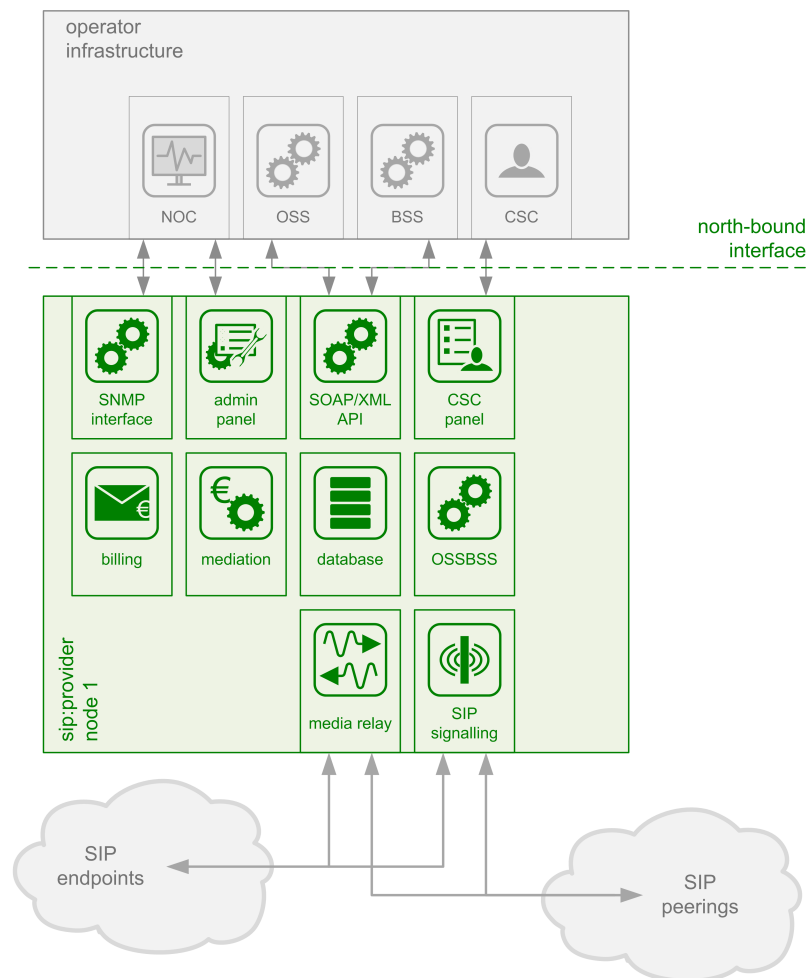

Figure 1: Architecture Overview

The main building blocks of Sipwise C5 are:

- SIP Signaling and Media Relay
- Provisioning
- Mediation and Billing

2.1 SIP Signaling and Media Relay

In SIP-based communication networks, it is important to understand that the signaling path (e.g. for call setup and tear-down) is completely independent of the media path. On the signaling path, the involved endpoints negotiate the call routing (which user

calls which endpoint, and via which path - e.g. using SIP peerings or going through the PSTN - the call is established) as well as the media attributes (via which IPs/ports are media streams sent and which capabilities do these streams have - e.g. video using H.261 or Fax using T.38 or plain voice using G.711). Once the negotiation on signaling level is done, the endpoints start to send their media streams via the negotiated paths.

The components involved in SIP and Media on the Sipwise C5 CE are shown in the following figure:

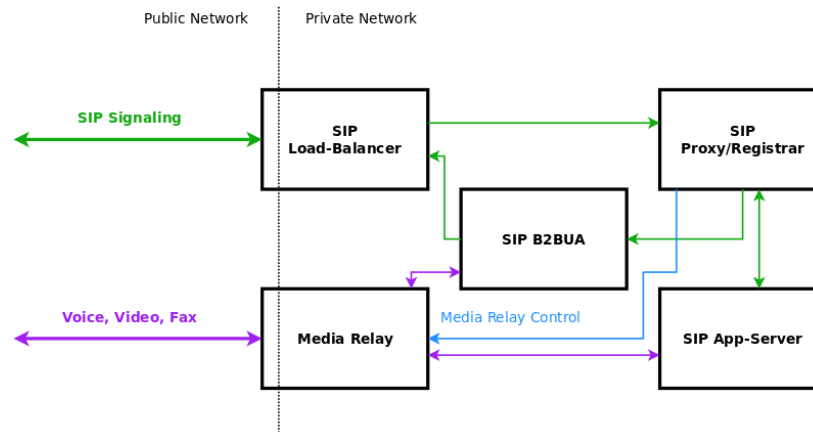

Figure 2: SIP and Media Relay Components

2.1.1 SIP Load-Balancer

The SIP load-balancer is a Kamailio instance acting as ingress and egress point for all SIP traffic to and from the system. It's a high-performance SIP proxy instance based on Kamailio and is responsible for sanity checks of inbound SIP traffic. It filters broken SIP messages, rejects loops and relay attempts and detects denial-of-service and brute-force attacks and gracefully handles them to protect the underlying SIP elements. It also performs the conversion of TLS to internal UDP and vice versa for secure signaling between endpoints and Sipwise C5, and does far-end NAT traversal in order to enable signaling through NAT devices.

The load-balancer is the only SIP element in the system which exposes a SIP interface to the public network. Its second leg binds in the switch-internal network to pass traffic from the public internet to the corresponding internal components.

The name load-balancer comes from the fact that in the commercial version, when scaling out the system beyond just one pair of servers, the load-balancer instance becomes its own physical node and then handles multiple pairs of proxies behind it.

On the public interface, the load-balancer listens on port 5060 for UDP and TCP, as well as on 5061 for TLS connections. On the internal interface, it speaks SIP via UDP on port 5060 to the other system components, and listens for XMLRPC connections on TCP port 5060, which is used by the OSSBSS system to control the daemon.

Its config files reside in `/etc/ngcp-config/templates/etc/kamailio/lb/`, and changes to these files are applied by executing `ngcpcfg apply "my commit message"`.

Tip

The SIP load-balancer can be managed via the commands `ngcp-service kamailio-lb start`, `ngcp-service kamailio-lb stop` and `ngcp-service kamailio-lb restart`. Its status can be queried by executing `ngcp-service kamailio-lb status` or `ngcp-service summary | grep "kamailio-lb"`. Also `ngcp-kamctl lb` and `ngcp-kamcmd lb` are provided for querying kamailio functions, for example: `ngcp-kamcmd lb htable.dump ipban`. Execute the command: `ngcp-kamctl lb fifo system.listMethods` or `ngcp-kamcmd lb system.listMethods` to get the list of all available queries.

2.1.2 SIP Proxy/Registrar

The SIP proxy/registrar (or short *proxy*) is the work-horse of Sipwise C5. It's also a separate Kamailio instance running in the switch-internal network and is connected to the provisioning database via MySQL, authenticates the endpoints, handles their registrations on the system and does the call routing based on the provisioning data. For each call, the proxy looks up the provisioned features of both the calling and the called party (either subscriber or domain features if it's a local caller and/or callee, or peering features if it's from/to an external endpoint) and acts accordingly, e.g. by checking if the call is blocked, by placing call-forwards if applicable and by normalizing numbers into the appropriate format, depending on the source and destination of a call.

It also writes start- and stop-records for each call, which are then transformed into call detail records (CDR) by the mediation system.

If the endpoints indicate negotiation of one or more media streams, the proxy also interacts with the *Media Relay* to open, change and close port pairs for relaying media streams over Sipwise C5, which is especially important to traverse NAT.

The proxy listens on UDP port 5062 in the system-internal network. It cannot be reached directly from the outside, but only via the SIP load-balancer.

Its config files reside in `/etc/ngcp-config/templates/etc/kamailio/proxy/`, and changes to these files are applied by executing `ngcpcfg apply "my commit message"`.

Tip

The SIP proxy can be controlled via the commands `ngcp-service kamailio-proxy start`, `ngcp-service kamailio-proxy stop` and `ngcp-service kamailio-proxy restart`. Its status can be queried by executing `ngcp-service kamailio-proxy status` or `ngcp-service summary | grep "kamailio-proxy"`. Also `ngcp-kamctl proxy` and `ngcp-kamcmd proxy` are provided for querying kamailio functions, for example: `ngcp-kamctl proxy ul show`. Execute the command: `ngcp-kamctl proxy fifo system.listMethods` or `ngcp-kamcmd proxy system.listMethods` to get the list of all available queries.

2.1.3 SIP Back-to-Back User-Agent (B2BUA)

The SIP B2BUA (also called SBC within the system) decouples the first call-leg (calling party to Sipwise C5) from the second call-leg (Sipwise C5 to the called party).

The software part used for this element is SEMS.

This element is typically optional in SIP systems, but it is always used for SIP calls (INVITE) that don't have Sipwise C5 as endpoint. It acts as application server for various scenarios (e.g. for feature provisioning via Vertical Service Codes and as Conferencing Server) and performs the B2BUA decoupling, topology hiding, caller information hiding, SIP header and Media feature filtering, outbound registration, outbound authentication and call length limitation as well as Session Keep-Alive handler.

Due to the fact that typical SIP proxies (like the load-balancer and proxy in Sipwise C5) do only interfere with the content of SIP messages where it's necessary for the SIP routing, but otherwise leave the message intact as received from the endpoints, whereas the B2BUA creates a new call leg with a new SIP message from scratch towards the called party, SIP message sizes are reduced significantly by the B2BUA. This helps to bring the message size under 1500 bytes (which is a typical default value for the MTU size) when it leaves Sipwise C5. That way, chances of packet fragmentation are quite low, which reduces the risk of running into issues with low-cost SOHO routers at customer sides, which typically have problems with UDP packet fragmentation.

The SIP B2BUA only binds to the system-internal network and listens on UDP port 5080 for SIP messages from the load-balancer or the proxy, on UDP port 5040 for control messages from the cli tool and on TCP port 8090 for XMLRPC connections from the OSSBSS to control the daemon.

Its configuration files reside in `/etc/ngcp-config/templates/etc/ngcp-sems`, and changes to these files are applied by executing `ngcpcfg apply "my commit message"`.

Tip

The SIP B2BUA can be controlled via the commands `ngcp-service sems start sbc`, `ngcp-service sems stop` and `ngcp-service sems restart`. Its status can be queried by executing `ngcp-service sems status` or `ngcp-service summary | grep "sems"`.

2.1.4 SIP App-Server

The SIP App-Server is an Asterisk instance used for voice applications like Voicemail and Reminder Calls. Asterisk uses the MySQL database as a message spool for voicemail, so it doesn't directly access the file system for user data. The voicemail plugin is a slightly patched version based on Asterisk 1.4 to make Asterisk aware of Sipwise C5 internal UUIDs for each subscriber. That way a SIP subscriber can have multiple E164 phone numbers, but all of them terminate in the same voicebox.

The App-Server listens on the internal interface on UDP port 5070 for SIP messages and by default uses media ports in the range from UDP port 10000 to 20000.

The configuration files reside in `/etc/ngcp-config/templates/etc/asterisk`, and changes to these files are applied by executing `ngcpcfg apply "my commit message"`.

Tip

The SIP App-Server can be controlled via the commands `ngcp-service asterisk start`, `ngcp-service asterisk stop` and `ngcp-service asterisk restart`. Its status can be queried by executing `ngcp-service asterisk status` or `ngcp-service summary | grep "asterisk"`.

2.1.5 Media Relay

The Media Relay (also called *rtengine*) is a Kernel-based packet relay, which is controlled by the SIP proxy. For each media stream (e.g. a voice and/or video stream), it maintains a pair of ports in the range of port number 30000 to 40000. When the media streams are negotiated, *rtengine* opens the ports in user-space and starts relaying the packets to the addresses announced by the endpoints. If packets arrive from different source addresses than announced in the SDP body of the SIP message (e.g. in case of NAT), the source address is implicitly changed to the address the packets are received from. Once the call is established and the *rtengine* has received media packets from both endpoints for this call, the media stream is pushed into the kernel and is then handled by a custom Sipwise iptables module to increase the throughput of the system and to reduce the latency of media packets.

The *rtengine* internally listens on UDP port 12222 for control messages from the SIP proxy. For each media stream, it opens two pairs of UDP ports on the public interface in the range of 30000 and 40000 per default, one pair on even port numbers for the media data, and one pair on the next odd port numbers for metadata, e.g. RTCP in case of RTP streams. Each endpoint communicates with one dedicated port per media stream (opposed to some implementations which use one pair for both endpoints) to avoid issues in determining where to send a packet to. The *rtengine* also sets the QoS/ToS/DSCP field of each IP packet it sends to a configured value, 184 (0xB8, *expedited forwarding*) by default.

The kernel-internal part of the *rtengine* is facilitated through an *iptables* module having the target name `RTPENGINE`. If any additional firewall or packet filtering rules are installed, it is imperative that this rule remains untouched and stays in place. Otherwise, if the rule is removed from *iptables*, the kernel will not be able to forward the media packets and forwarding will fall back to the user-space daemon. The packets will still be forwarded normally, but performance will be much worse under those circumstances, which will be especially noticeable when a lot of media streams are active concurrently. See the section on *Firewalling* for more information.

The *rtengine* configuration file is `/etc/ngcp-config/templates/etc/default/ngcp-rtengine-daemon`, and changes to this file are applied by executing `ngcpcfg apply "my commit message"`. The UDP port range can be configured via the `config.yml` file under the section `rtpproxy`. The QoS/ToS value can be changed via the key `qos.tos_rtp`.

Tip

The Media Relay can be controlled via the commands `ngcp-service rtengine start`, `ngcp-service rtengine stop` and `ngcp-service rtengine restart`. Its status can be queried by executing `ngcp-service rtengine status` or `ngcp-service summary | grep "rtengine"`.

2.2 Redis Database

The redis database is used as a high-performance key/value storage for global system data. This includes calls information and concurrent calls counters for customers and subscribers, etc..

3 Initial Installation

3.1 Prerequisites

For an initial installation of Sipwise C5 , it is mandatory that your production environment meets the following criteria:

HARDWARE REQUIREMENTS

- Recommended: Dual-core, x86_64 compatible, 3GHz, 4GB RAM, 128GB HDD
- Minimum: Single-core, x86_64 compatible, 1GHz, 2GB RAM, 24GB HDD

SUPPORTED OPERATING SYSTEMS

- Debian 10 (buster) 64-bit

INTERNET CONNECTION

- Hardware needs connection to the Internet



Important

Only **Debian 10 (buster) 64-bit** is currently supported as a host system for Sipwise C5 .



Important

It is **HIGHLY** recommended that you use a **dedicated server** (either a physical or a virtual one) for Sipwise C5, because the installation process will wipe out existing MySQL databases and modify several system configurations.

3.2 Using Sipwise C5 install CD (recommended)

The install CD provides the ability to easily install Sipwise C5 CE/PRO/Carrier, including automatic partitioning and installation of the underlying Debian system.



Important

PRO/Carrier can be installed only with a commercial license. Otherwise a warning about lack of access to Debian repository will be displayed.

You can install the current Sipwise C5 CE version mr7.5.1 using [install CD image](#) (checksums: [sha1](#) , [md5](#)).

Important

The Sipwise C5 install CD automatically takes care of partitioning, any present data will be overwritten! While the installer prompts for the disk that should be used for installation before its actual execution, it's strongly recommended to boot the ISO in an environment with empty disks or disks that you don't plan to use for anything else than the newly installed Sipwise C5 system.

Tip

When DHCP is available in your infrastructure then you shouldn't have to configure anything, just choose `DHCP` and press enter. If network configuration still doesn't work as needed a console based network configuration system will assist you in setting up your network configuration. VLANs are also supported at this stage.

Also, you can use Sipwise C5 **install CD** to boot the Grml (Debian based live system) rescue system, check RAM using a memory testing tool or install plain Debian system for manual installation using Sipwise C5 installer.

3.3 Using the Sipwise C5 installer

3.3.1 Installing the Operating System

You need to install Debian 10 (buster) 64-bit on the server. A **basic** installation without any additional task selection (like *Desktop System*, *Web Server* etc.) is sufficient.

Tip

Sipwise recommends using the latest **Netinstall ISO** as installation medium.

Important

If you use other kinds of installation media (e.g. provided by your hosting provider), prepare for some issues that might come up during installation. For example, you might be forced to manually resolve package dependencies in order to install Sipwise C5 . Therefore, it is **HIGHLY RECOMMENDED** to use a clean Debian installation to simplify the installation process.

Note

If you installed your system using the Debian CDs/DVDs (so neither using Sipwise C5 install CD nor **the Debian Netinstall ISO**) `apt-get` might prompt to insert disk to proceed during Sipwise C5 installation. The prompt won't be visible for you and installation hangs. Please disable the cdrom entries in `/etc/apt/sources.list` and enable a Debian mirror (e.g. <https://deb.debian.org/debian/>) instead.

3.3.1.1 Using special Debian setups

If you plan to install Sipwise C5 on Virtual Hosting Providers like *Dreamhost* with their provided Debian installer, you might need to manually prepare the system for Sipwise C5 installation, otherwise the installer will fail installing certain package versions required

to function properly.

Using Dreamhost Virtual Private Server

A Dreamhost virtual server uses apt-pinning and installs specific versions of MySQL and apache, so you need to clean this up beforehand.

Note

Apache is not used by default since mr3.6.1, still better to remove pinned Apache version.

```
apt-get remove --purge mysql-common ndn-apache22
mv /etc/apt/preferences /etc/apt/preferences.bak
apt-get update
apt-get dist-upgrade
```



Warning

Be aware that this step will break your web-based system administration provided by Dreamhost. Only do it if you are certain that you won't need it.

3.3.2 Installing the Sipwise C5

Download and install the latest *Sipwise C5* installer package:

```
PKG=ngcp-installer-mr7.5.1.deb
wget http://deb.sipwise.com/spce/${PKG}
dpkg -i ${PKG}
```

Run the installer as root user:

```
ngcp-installer
```

Note

You can find the previous versions of *Sipwise C5* installer package [here](#).

The installer will ask you to confirm that you want to start the installation. Read the given information **carefully**, and if you agree, proceed with *y*.

The installation process will take several minutes, depending on your network connection and server performance. If everything goes well, the installer will (depending on the language you use), show something like this:

```
Installation finished. Thanks for choosing Sipwise C5 Community Edition.  
Please reboot the server to continue with the configuration.
```

**Warning**

Be aware that all services will be disabled. If you need a specific service - re-enable it when the initial configuration is done.

During the installation, you can watch the background processing by executing the following command on a separate console:

```
tail -f /var/log/ngcp-installer.log
```

3.4 Using a pre-installed virtual machine

For quick test deployments, pre-installed virtualization images are provided. These images are intended to be used for quick test, not recommended for production use.

3.4.1 Vagrant box for VirtualBox

Vagrant is an open-source software for creating and configuring virtual development environments. Sipwise provides a so called Vagrant base box for your service, to easily get direct access to your own Sipwise C5 Virtual Machine without any hassles.

Note

The following software must be installed to use Vagrant boxes: **VirtualBox v.5.2.26+** and **Vagrant v.2.2.3+**.

Get your copy of Sipwise C5 by running:

```
vagrant init spce-mr7.5.1 https://deb.sipwise.com/spce/images/mr7.5.1/sip_provider_CE_mr7 ↔  
    .5.1_vagrant.box  
vagrant up
```

As soon as the machine is up and ready you should have your local copy of Sipwise C5 with the following benefits:

- all the software and database are automatically updated to the latest available version
- the system is configured to use your LAN IP address (received over DHCP)

- basic SIP credentials to make SIP-2-SIP calls out of the box are available

Use the following command to access the terminal:

```
vagrant ssh
```

or login to Administrator web-interface at <https://127.0.0.1:1443/login/admin> (with default user *administrator* and password *administrator*).

There are two ways to access VM resources, through NAT or Bridge interface:

Note

a.b.c.d is IP address of VM machine received from DHCP; x.y.z.p is IP address of your host machine

Table 1: Vagrant based VirtualBox VM interfaces:

Description	Host-only address	LAN address	Notes
SSH	ssh://127.0.0.1:2222	ssh://a.b.c.d:22 or ssh://x.y.z.p:2222	Also available via " <i>vagrant ssh</i> "
Administrator interface	https://127.0.0.1:1443/login/admin	https://a.b.c.d:1443/login/admin or https://x.y.z.p:1443/login/admin	
New Customer self care interface	https://127.0.0.1:1443	https://a.b.c.d:1443 or https://x.y.z.p:1443	new self-care interface based on powerful ngcp-panel framework
Old Customer self care interface	https://127.0.0.1:22443	https://a.b.c.d:443 or https://x.y.z.p:22443	will be removed in upcoming releases
Provisioning interfaces	https://127.0.0.1:2443	https://a.b.c.d:2443 or https://x.y.z.p:2443	
SIP interface	not available	sip://a.b.c.d:5060	Both TCP and UDP are available.

Note

VM ports smaller than 1024 mapped to ports 22<vm_port> through NAT, otherwise root on host machine requires to map them. It means SSH port 22 mapped to port 2222, WEB port 443 → 22443.

VM IP address (a.b.c.d), as well as SIP credentials will be printed to terminal during "vagrant up" stage, e.g.:

```
[20_add_sip_account] Adding SIP credentials...
[20_add_sip_account] - removing domain 192.168.1.103 with subscribers
[20_add_sip_account] - adding domain 192.168.1.103
[20_add_sip_account] - adding subscriber 43991002@192.168.1.103 (pass: 43991002)
[20_add_sip_account] - adding subscriber 43991003@192.168.1.103 (pass: 43991003)
[20_add_sip_account] - adding subscriber 43991004@192.168.1.103 (pass: 43991004)
[20_add_sip_account] - adding subscriber 43991005@192.168.1.103 (pass: 43991005)
[20_add_sip_account] - adding subscriber 43991006@192.168.1.103 (pass: 43991006)
[20_add_sip_account] - adding subscriber 43991007@192.168.1.103 (pass: 43991007)
[20_add_sip_account] - adding subscriber 43991008@192.168.1.103 (pass: 43991008)
[20_add_sip_account] - adding subscriber 43991009@192.168.1.103 (pass: 43991009)
[20_add_sip_account] You can USE your VM right NOW: https://192.168.1.103:1443/login/admin
```

To turn off your Sipwise C5 virtual machine, just type:

```
vagrant halt
```

To completely remove Sipwise C5 virtual machine, use:

```
vagrant destroy
vagrant box remove spce-mr7.5.1
```

Further documentation for Vagrant is available [at the official Vagrant website](#).

Vagrant usage tips:

- Default SSH login is *root* and password is *sipwise*. SSH connection details can be displayed via:

```
vagrant ssh-config
```

- VirtualBox Guest Additions is installed by default but disabled. Enable it to use [Vagrant Synced Folders](#) feature. Execute the following commands inside VM:

```
systemctl start vboxadd-service.service vboxadd.service
ngcpcfg set /etc/ngcp-config/config.yml "systemd.custom_preset=['vboxadd-service.service ←
', 'vboxadd.service']"
ngcpcfg apply "Start VirtualBox Guest Additions on boot"
```

- You can download a Vagrant box for VirtualBox from [here](#) manually (checksums: [sha1](#), [md5](#)).

3.4.2 VirtualBox image

You can download a VirtualBox image from [here](#) (checksums: [sha1](#), [md5](#)). Once you have downloaded the file you can import it to VirtualBox via its import utility.

The format of the image is *ova*. If you have VirtualBox 3.x running, which is not compatible with *ova* format, you need to extract the file with any *tar* compatible software and import the *ovf* file which is inside the archive.

On Linux, you can do it like this:

```
tar xvf sip_provider_CE_mr7.5.1_virtualbox.ova
```

On Windows, right-click on the *ova* file, choose *Open with* and select *WinZIP* or *WinRAR* or any other application able to extract *tar* archives. Extract the files to any place and import the resulting *ovf* file in VirtualBox.

Considerations when using this virtual machine:

- You will need a 64bit guest capable VirtualBox setup.
- The root password is *sipwise*
- You should use *bridge mode* networking (adjust your bridging interface in the virtual machine configuration) to avoid having Sipwise C5 behind NAT.
- You'll need to adjust your timezone and keyboard layout.
- The network configuration is set to DHCP. You'll need to change it to the appropriate static configuration.
- As the virtual image is a static file, it won't contain the most updated versions of our software. Please upgrade the system via `apt` as soon as you boot it for the first time.

3.4.3 VMware image

You can download a VMware image from [here](#) (checksums: [sha1](#), [md5](#)). Once you have downloaded the file just extract the *zip* file and copy its content to your virtual machines folder.

Considerations when using this virtual machine:

- You will need a 64bit guest capable vmware setup.
- The root password is *sipwise*
- You'll need to adjust your timezone and keyboard layout.
- The network configuration is set to DHCP. You'll need to change it to the appropriate static configuration.
- As the virtual image is a static file, it won't contain the most updated versions of our software. Please upgrade the system via `apt` as soon as you boot it for the first time.

3.4.4 Amazon EC2 image

Sipwise provides AMI (Amazon Machine Images) images in all Amazon EC2 regions for the latest and LTS Sipwise C5 releases. Please find the appropriate AMI ID for your region in [release announcement](#).

Note

The following documentation will use Amazon region *eu-west-1* with AMI ID *ami-8bef6cfc* as an example. Please find the appropriate AMI ID for your region in [the latest release announcement](#).

As a next step please visit <https://console.aws.amazon.com/ec2/v2/home?region=eu-west-1> with your EC2 account.

Choose "Launch Instance":

Create Instance

To start using Amazon EC2 you will want to launch a virtual server, known as an Amazon EC2 instance.

[Launch Instance](#)

Note: Your instances will launch in the EU West (Ireland) region

Figure 3: Launch Amazon EC2 Instance for your region

Select "Community AMIs" option, enter "ami-8bef6cfc" inside the search field and press "Select" button:

1. Choose AMI 2. Choose Instance Type 3. Configure Instance 4. Add Storage 5. Tag Instance 6. Configure Security Group 7. Review

Cancel and Exit

Step 1: Choose an Amazon Machine Image (AMI)

An AMI is a template that contains the software configuration (operating system, application server, and applications) required to launch your instance. You can select an AMI provided by AWS, our user community, or the AWS Marketplace; or you can select one of your own AMIs.

Quick Start

My AMIs

AWS Marketplace

Community AMIs

Search: ami-37b87340

ngcp-ce-mr3.3.1 - ami-37b87340

Official sip:provider CE AMI for release mr3.3.1.3 [2014-06-23_20:51]

Root device type: ebs Virtualization type: paravirtual

Select

64-bit

Figure 4: Choose an image (different for each region)

Select the Instance Type you want to use for running Sipwise C5 (recommended: ≥ 4 GB RAM):

- 1. Choose AMI
- 2. Choose Instance Type
- 3. Configure Instance
- 4. Add Storage
- 5. Add Tags
- 6. Configure Security Group
- 7. Review

Step 2: Choose an Instance Type

Amazon EC2 provides a wide selection of instance types optimized to fit different use cases. Instances are virtual servers that can run applications. They have varying combinations of CPU, memory, storage, and networking capacity, and give you the flexibility to choose the appropriate mix of resources for your applications. [Learn more](#) about instance types and how they can meet your computing needs.

Filter by: All instance types Current generation [Show/Hide Columns](#)

Currently selected: t2.medium (Variable ECUs, 2 vCPUs, 2.3 GHz, Intel Broadwell E5-2686v4, 4 GiB memory, EBS only)

	Family	Type	vCPUs	Memory (GiB)	Instance Storage (GB)	EBS-Optimized Available	Network Performance	IPv6 Support
<input type="checkbox"/>	General purpose	t2.nano	1	0.5	EBS only	-	Low to Moderate	Yes
<input type="checkbox"/>	General purpose	t2.micro Free tier eligible	1	1	EBS only	-	Low to Moderate	Yes
<input type="checkbox"/>	General purpose	t2.small	1	2	EBS only	-	Low to Moderate	Yes
<input checked="" type="checkbox"/>	General purpose	t2.medium	2	4	EBS only	-	Low to Moderate	Yes
<input type="checkbox"/>	General purpose	t2.large	2	8	EBS only	-	Low to Moderate	Yes
<input type="checkbox"/>	General purpose	t2.xlarge	4	16	EBS only	-	Moderate	Yes
<input type="checkbox"/>	General purpose	t2.2xlarge	8	32	EBS only	-	Moderate	Yes

Figure 5: Choose Amazon EC2 instance

Tip

Do not forget to tune necessary Sipwise C5 performance parameters depending on Amazon EC2 instance type and performance you are looking for. Find more information about Sipwise C5 performance tuning in Section 16.9.

Run through next configuration options

- Configure Instance: optional (no special configuration required from Sipwise C5)
- Add Storage: choose >=8GB disk size (no further special configuration required from Sipwise C5)
- Tag Instance: optional (no special configuration required from Sipwise C5)
- Configure Security Group: create a new security group (SSH on port 22, HTTPS on port 443, TCP on ports 1443, 2443, 1080 and 5060 as well as UDP on port 5060 are suggested)

Note

Please feel free to restrict the *Source* options in your Security Group to your own (range of) IP addresses.

- [1. Choose AMI](#)
- [2. Choose Instance Type](#)
- [3. Configure Instance](#)
- [4. Add Storage](#)
- [5. Tag Instance](#)
- [6. Configure Security Group](#)
- [7. Review](#)

Step 6: Configure Security Group

A security group is a set of firewall rules that control the traffic for your instance. On this page, you can add rules to allow specific traffic to reach your instance. For example, if you want to set up a web server and allow Internet traffic to reach your instance, add rules that allow unrestricted access to the HTTP and HTTPS ports. You can create a new security group or select from an existing one below. [Learn more](#) about Amazon EC2 security groups.

Assign a security group: Create a **new** security group
 Select an **existing** security group

Security group name:

Description:

Type <small>i</small>	Protocol <small>i</small>	Port Range <small>i</small>	Source <small>i</small>
SSH	TCP	22	Anywhere 0.0.0.0/0
HTTPS	TCP	443	Anywhere 0.0.0.0/0
Custom TCP Rule	TCP	1443	Anywhere 0.0.0.0/0
Custom TCP Rule	TCP	2443	Anywhere 0.0.0.0/0
Custom TCP Rule	TCP	1080	Anywhere 0.0.0.0/0
Custom TCP Rule	TCP	5060	Anywhere 0.0.0.0/0
Custom UDP Rule	UDP	5060	Anywhere 0.0.0.0/0

Warning
 Rules with source of 0.0.0.0/0 allow all IP addresses to access your instance. We recommend setting security group rules to allow access from known IP addresses only.

Figure 6: Configure Security Group

Finally Review instance launch and press "Launch" button:

- 1. Choose AMI
- 2. Choose Instance Type
- 3. Configure Instance
- 4. Add Storage
- 5. Tag Instance
- 6. Configure Security Group
- 7. Review

Step 7: Review Instance Launch

▼ AMI Details [Edit AMI](#)

ngcp-ce-mr3.3.1 - ami-37b87340
Official sip:provider CE AMI for release mr3.3.1.3 [2014-06-23_20:51]
 Root Device Type: ebs Virtualization type: paravirtual

▼ Instance Type [Edit instance type](#)

Instance Type	ECUs	vCPUs	Memory (GiB)	Instance Storage (GB)	EBS-Optimized Available	Network Performance
m3.medium	3	1	3.75	1 x 4	-	Moderate

▼ Security Groups [Edit security groups](#)

Security group name ngcp-ce-ec2-demo
Description Settings for sip:provider CE

Type ⓘ	Protocol ⓘ	Port Range ⓘ	Source ⓘ
SSH	TCP	22	0.0.0.0/0
HTTPS	TCP	443	0.0.0.0/0
Custom TCP Rule	TCP	1443	0.0.0.0/0
Custom TCP Rule	TCP	2443	0.0.0.0/0
Custom TCP Rule	TCP	1080	0.0.0.0/0
Custom TCP Rule	TCP	5060	0.0.0.0/0
Custom UDP Rule	UDP	5060	0.0.0.0/0

▶ Instance Details [Edit instance details](#)

▶ Storage [Edit storage](#)

Cancel Previous Launch

Figure 7: Launch Amazon EC2 instance with Sipwise C5

Choose an existing key pair which you want to use for logging in, or create a new one if you don't have one.

Select an existing key pair or create a new key pair ✕

A key pair consists of a **public key** that AWS stores, and a **private key file** that you store. Together, they allow you to connect to your instance securely. For Windows AMIs, the private key file is required to obtain the password used to log into your instance. For Linux AMIs, the private key file allows you to securely SSH into your instance.

Note: The selected key pair will be added to the set of keys authorized for this instance. Learn more about [removing existing key pairs from a public AMI](#).

Create a new key pair

Key pair name

sip-provider-ce

Download Key Pair



You have to download the **private key file** (*.pem file) before you can continue. **Store it in a secure and accessible location.** You will not be able to download the file again after it's created.

Cancel

Launch Instances

Figure 8: Choose a key pair to access the system

You should have a running instance after a few seconds/minutes now (check DNS name/IP address).

The screenshot shows the AWS Management Console interface for EC2 instances. On the left, there is a navigation menu with options like EC2 Dashboard, Events, Tags, Reports, Limits, INSTANCES, Instances, Spot Requests, and Reserved Instances. The main area displays a table of instances. The table has columns for Name, Instance ID, Instance Type, Availability, Instance State, Status Checks, Alarm Sta, Public DNS, and Public IP. One instance is listed with Instance ID i-ab68c7e8, Instance Type m3.medium, Availability eu-west-1b, Instance State running, Status Checks Initializing, Alarm Sta None, Public DNS ec2-54-195-40-219.eu..., and Public IP 54.195.40.0. Above the table, there are buttons for Launch Instance, Connect, and Actions, and a search filter for i-ab68c7e8.

Name	Instance ID	Instance Type	Availability	Instance State	Status Checks	Alarm Sta	Public DNS	Public IP
	i-ab68c7e8	m3.medium	eu-west-1b	running	Initializing	None	ec2-54-195-40-219.eu...	54.195.40.0

Figure 9: Running Amazon EC2 Sipwise C5 instance

First step should be logging in to the Admin panel (username *administrator*, password *administrator*) and changing the default password: [https://\\$DNS:1443/login/admin](https://$DNS:1443/login/admin) and then follow Section 16 to secure your installation.

Logging in via SSH should work now, using the key pair name (being sip-provider-ce.pem as \$keypair in our example) and the

DNS name/IP address the system got assigned.

```
ssh -i $keypair.pem admin@$DNS
```

Now you can increase your privileges to user *root* for further system configuration:

```
sudo -s
```

Don't forget to add the Advertised IP for kamailio lb instance, since it's required by the Amazon EC2 network infrastructure:

```
ngcp-network --set-interface=eth0 --advertised-ip=<your_public_amazon_ip>
```

and apply your changes:

```
ngcpcfg apply 'add advertised-ip on interface eth0'
```

Now feel free to use your newly started Amazon EC2 Sipwise C5 instance!

**Warning**

Do not forget to stop unnecessary instance(s) to avoid unexpected costs (see <https://aws.amazon.com/ec2/pricing/>).

4 Initial System Configuration

After the installation has finished successfully and the server gets rebooted it is necessary to perform the initial configuration:

**Warning**

It is strongly recommended to run `ngcp-initial-configuration` within terminal multiplexer like `screen`.

```
screen -S ngcp
ngcp-initial-configuration
```

The tool will ask you to confirm the network configuration which is based on the current one. Read **carefully** the information printed on screen, and if you agree, proceed by typing *y*. If you want to change these parameters, you can edit the file `/etc/ngcp-installer/config_deploy.inc` and adjust the variables with the desired values.

If everything goes well, you should see the message:

```
System was successfully configured, now you have the best VoIP software.
```

After the configuration you are ready to adjust the system parameters to your needs to make the system work properly.

4.1 Network Configuration

If you have only one network card inside your system, its device name is *eth0*, it's configured and only IPV4 is important to you then there should be nothing to do for you at this stage. If multiple network cards are present, your network card does *not* use *eth0* for its device name or you need IPv6 then the only parameter you need to change at this moment is the listening address for your SIP services.

To do this, you have to specify the interface where your listening address is configured, which you can do with the following command (assuming your public interface is *eth0*):

```
ngcp-network --set-interface=eth0 --ip=auto --netmask=auto --hwaddr=auto
ngcp-network --move-from=lo --move-to=eth0 --type=web_ext --type=sip_ext --type=rtp_ext -- ←
type=ssh_ext --type=web_int
```

If you want to enable IPv6 as well, you have to set the address on the proper interface as well, like this (assuming you have an IPv6 address *fd0a:5cc1:23:4:0:0:0:1f* on interface *eth0*):

```
ngcp-network --set-interface=eth0 --ipv6='FD0A:5CC1:23:4:0:0:0:1F'
```

Tip

Always use a full IPv6 address with 8 octets. Leaving out zero octets (e.g. *FD0A:5CC1:23:4::1F*) is **not allowed**.



Important

You should use the IPv6 address in **upper-case** because LB (kamailio) handles the IPv6 addresses internally in upper-case format.

Check or adjust the network configuration in the */etc/ngcp-config/network.yml* file.

```
editor /etc/ngcp-config/network.yml
```

The following configuration shows C5 running in the internal 192.168.0.0/24 network behind the NAT:

```
...
self:
  eth0:
    dns_nameservers:
      - 192.168.0.1
    hwaddr: 11:22:33:44:55:66
    ip: 192.168.0.10
    gateway: 192.168.0.1
    netmask: 255.255.255.0
    type:
      - ssh_ext
      - web_ext
      - web_int
      - sip_ext
      - rtp_ext
      - mon_ext
    interfaces:
      - lo
      - eth0
    lo:
...

```

Apply the adjusted network configuration, and `/etc/network/interfaces` will be regenerated from the new configuration.

```
ngcpcfg apply 'change network configuration'
```

The resulting `/etc/network/interfaces` file will look like this:

```
# File autogenerated by ngcpcfg

# lo -----
auto lo
iface lo inet loopback
# -----

# eth0 -----
auto eth0
iface eth0 inet static
    address 192.168.0.10
    netmask 255.255.255.0
    gateway 192.168.0.1
    dns-nameservers 192.168.0.1
# -----

```

Reboot the server to apply the new network configuration:

```
reboot
```

4.2 Apply Configuration Changes

In order to apply the changes you made to `/etc/ngcp-config/config.yml`, you need to execute the following command to re-generate your configuration files and to automatically restart the services:

```
ngcpcfg apply 'added network interface'
```

Tip

At this point, your system is ready to serve.

4.3 Start Securing Your Server

During installation, the system user `cdrexpert` is created. This jailed system account is supposed to be used to export CDR files via sftp/scp. Set a password for this user by executing the following command:

```
passwd cdrexpert
```

The installer has set up a MySQL database on your server. You need to set a password for the MySQL root user to protect it from unauthorized access by executing this command:

```
mysqladmin password <your mysql root password>
```

For the *Administrative Web Panel* located at `https://<your-server-ip>:1443/login/admin`, a default user `administrator` with password `administrator` has been created. Connect to the panel (accept the SSL certificate for now) using those credentials and change the password of this user by going to *Settings*→*Administrators* and click the *Edit* when hovering over the row.

4.4 Configuring the system-wide editor

The default editor is set to `nano` on the system. If you prefer a different editor, make sure it's installed and set the default editor via:

```
sudo update-alternatives --config editor
```

Tip

if you want to use a specific editor only temporarily, set the *EDITOR* environment variable instead. For example to run *command* with the editor set to *vim*, invoke "*EDITOR=vim command*".

4.5 Configuring the Email Server

The Sipwise C5 installer will install *mailx* (which has *Exim4* as MTA as a default dependency) on the system, however the MTA is not configured by the installer. If you want to use the *Voicemail-to-Email* feature of the Voicebox, you need to configure your MTA properly. If you are fine to use the default MTA *Exim4*, execute the following command:

```
sudoedit /etc/ngcp-config/config.yml # edit section 'email:' according to your needs
sudo ngcpcfg apply 'adjust exim4 / MTA configuration'
```

**Important**

You are free to install and configure any other MTA (e.g. postfix) on the system, if you are more comfortable with that.

4.6 Advanced Network Configuration

You have a typical test deployment now and you are good to go, however you may need to do extra configuration depending on the devices you are using and functionality you want to achieve.

4.7 What's next?

To test and use your installation, you need to follow these steps now:

1. Create a SIP domain
2. Create some SIP subscribers
3. Register SIP endpoints to the system
4. Make local calls and test subscriber features
5. Establish a SIP peering to make PSTN calls

Please read the next chapter for instructions on how to do this.

5 VoIP Service Administration Concepts

5.1 Contacts

A contact contains information such as the name, the postal and email addresses, and others. A contact's main purpose is to identify entities (resellers, customers, peers and subscribers) it is associated with.

A person or an organization may represent a few entities and it is handy to create a corresponding organization's contact beforehand and use it repeatedly when creating new entities. In this case we suggest populating the **External #** field to distinguish between customers associated with the same contact.

Reseller	Contact	Customer	External #
Default	Rylic Longstaff	DTS	0007
		Morning Times	0008
TelephOne	Clare Fenn	Lantern Co	—
	Ike Leonard	City Bank	—

Note that the only required contact field is **email**. For contacts associated with customers, it will be used for sending invoices and notifications such as password reset, new subscriber creation and others. A contact for a subscriber is created automatically but only if you specify an email address for this subscriber. It is mainly used to send notification messages, e.g. in case of a password reset.

5.2 Resellers

The reseller model allows you to expand your presence in the market by including virtual operators in the sales chain. A virtual operator can be a company without its own VoIP platform and even without a technical background, but with sales presence in a market. You define such a company as a reseller in the platform: grant limited access to the administrative web interface (the reseller administrator will only see his own customers, domains and billing profiles) and define wholesale rates for this reseller. Then, the reseller is free to operate under its own brand, make up its retail rates, establish the customer base and resell your services to its customers. The reseller's profit is a margin between the wholesale and retail rates.

Let us consider an example:

- You operate in Munich and provide residential and business services.
- A company Cheap Call that has a strong presence in Frankfurt offers to resell your services under its own brand in this city.
- You define wholesale rates for Cheap Call, such as calls to Argentina at €0,03.
- Cheap Call defines its retail price and offers calls to Argentina at €0,04.
- When one of Cheap Call's subscribers makes a 5-minute call to Argentina, this subscriber will be charged €0,20.
- You will get €0,15 revenue and Cheap Call's profit will be €0,20 - €0,15 = €0,05.

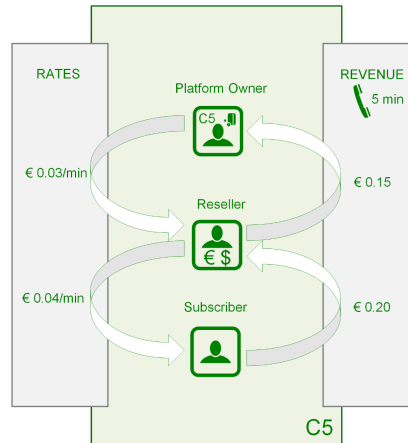

A reseller usually uses dedicated IP addresses or SIP domain names to provide services. Also, a reseller can rebrand the self-care web interface for its customers and select languages per SIP domain that allows the reseller to operate even in multiple countries.

5.3 SIP Domain

A SIP domain represents an external Internet address where your subscribers register their SIP phones to make calls or send messages. The SIP domain also contains particular default configuration for all the subscribers registered with this SIP domain. A SIP domain can be a regular FQDN (e.g. sip.yourdomain.com) or a NAPTR/SRV record. Using IP addresses for SIP domains in production is **strongly discouraged**.

5.3.1 Additional SIP Domains

You can create as many SIP domains as required to satisfy your networking or marketing requirements, e.g.:

- A dedicated SIP domain is *suggested* per CloudPBX customer.
- A separate SIP domain may be dedicated to every whitelabel reseller.
- Multiple SIP domains may be used to provide services in different countries or regions.
- Multiple SIP domains may be used to brand your own services.

Domain	Purpose
sip.yourdomain.com	Your own domain for retail customers
sip.enterprise.com	Your big customer with Cloud PBX
sip.reseller.com	Your white-label reseller
sip.yourdomain.de	Your domain for providing a new service in another country

5.4 Contracts

A contract is a combination of a *contact* and a *billing profile*, hence it represents a business contract for your resellers and peering partners.

Contracts can be created in advance on the *Reseller and Peering Contracts* page, or immediately during creation of a peer or a reseller.

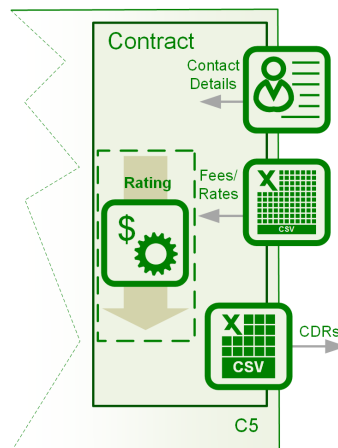

Note that the *customer* entity (described below) is a special type of the contract. A customer entity has an email and an invoice templates in addition to a contact and a billing profile.

5.5 Customers

A customer is a physical or legal entity whom you provide the VoIP service with and send invoices to. Here are the main features of a customer:

- Contains the contact and legal information. For example, an address or an email address for invoicing.
- Associated with a billing profile (to define fees per destination) and tracks the balance (used mostly for post-paid customers).
- Contains a certain number of subscribers who actually use the service and whose calls appear in the customer's list of CDRs.
- Provides some default parameters for all its subscribers. For example, voice prompts and call restriction.

Here are two common examples of the customer model:

5.5.1 Residential and SOHO customers

With this service you provide your residential and SOHO customers with one or multiple numbers and offer the service on a post-paid basis.

For a residential customer you usually create one *customer* entity with one *subscriber* under it. A residential customer can register multiple devices with the same number thus having a convenient Viber or Skype-like service: any device can be used to make a

call and all of them will ring simultaneously when there is an incoming call. At the end of the billing period, you send an invoice to the customer.

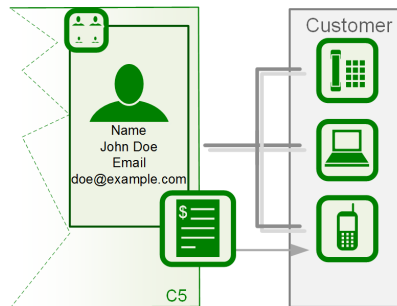

For SOHO customers you usually create multiple subscribers under the same customer and assign every subscriber a dedicated number to allow users make and receive calls. A common invoice will contain calls of all the subscribers.

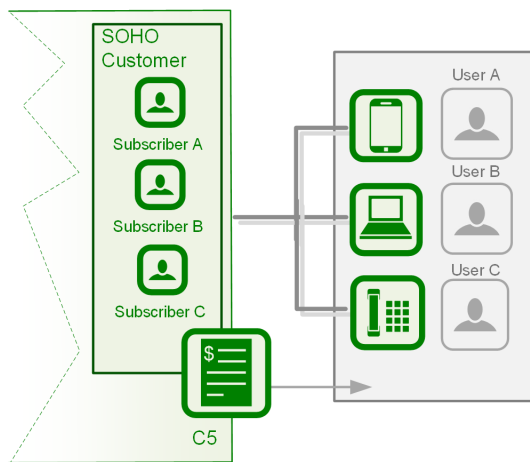

5.5.2 Business customers with the Cloud PBX service

In this case you create a Customer and all the required entities under it to reflect the company's structure: subscribers, extensions, hunt groups, auto-attendant menus, etc.

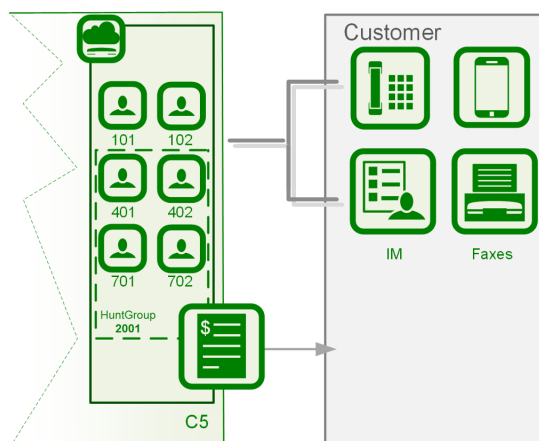

5.5.3 SIP Trunking

If a customer PBX can register itself with C5, you create a regular subscriber for it and configure a standard username/password authentication. Multiple PBX users can then send and receive calls.

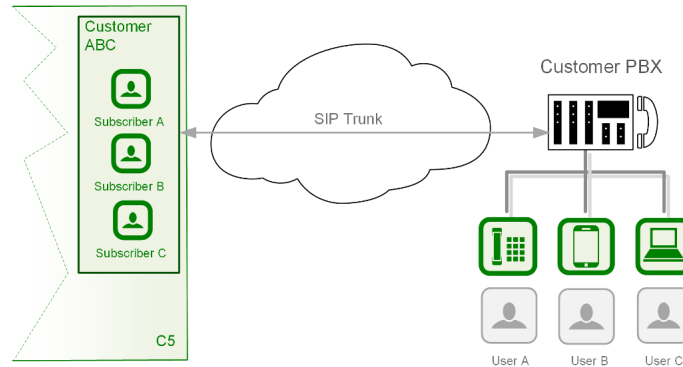

Legacy PBX devices that are not capable of passing the *challenge*-based authentication can be authenticated by the IP address. Optionally, every user of such a PBX can be authenticated separately by the FROM header and the IP address. For more details, refer to the [Trusted Sources](#) section.

5.5.4 Mobile subscribers

The pre-paid model works perfectly for **mobile application users**. In this case you generally create a single subscriber under a customer.

5.5.5 Pre-paid subscribers who use your calling cards

In this case you will most likely create a single subscriber under a customer, although multiple subscribers would work as well. In the latter case, they will share and top-up the common balance. Notice that the *customer* entity itself does not contain any technical configuration for the VoIP service authentication and instead contains other entities called *subscribers*, which do.

5.6 Subscribers

Every subscriber represents a SIP line or a SIP trunk. For example, in the residential services a subscriber entity is dedicated to every user. In the SIP trunking scenario, a subscriber can be used to authenticate all VoIP traffic from the remote PBX device.

In the following table logical subscriber types and their purpose are described.

Service	Subscriber Type	Purpose	Features
Residential	Regular subscriber	A regular VoIP service	Requires a DID number to receive calls from outside of your network
Enterprise (CloudPBX)	Pilot subscriber	A base number for the enterprise customer; Lists all extra numbers (aliases)	Configures the rest of customer subscribers in its self-care web interface

Service	Subscriber Type	Purpose	Features
	Extension	Extra numbers (DIDs, "implicit" extensions) for the enterprise customer	Can be dialed in different ways; The number configuration builds on top of the Pilot subscriber
	PBX Group	Forwards incoming calls to multiple extensions	Ringling policy defines in which order the extensions will ring
SIP Trunk	Digest authentication	Dynamically registers a remote IP PBX device	Handles multiple users behind the IP PBX device
	IP authentication	IP authentication of legacy IP PBX devices incapable of registering with the platform	Might require Trusted Subscriber and Trusted Source configuration
Prepaid	Regular subscriber with prepaid billing profile	Authorization of services based on customer balance; Disconnection of calls on "zero balance"	Vouchers and Balance Top-Up ; Billing Profile Packages

Tip

Subscriber **Aliases** can provide Extra DIDs or extension numbers to a subscriber.

5.7 SIP Peerings

A SIP peering is your interconnection with the external VoIP or PSTN network. Usually, a VoIP service provider has at least a few termination partners to offer its subscribers calls to virtually any landline and mobile destination.

SIP peerings also enable incoming calls to your platform. For example, if you rent a pool of DID numbers from a SIP peer and offer them to your residential and business customers.

An interconnection with your termination partners and DID number providers can include multiple servers and enable both out-bound and inbound calls, hence such a configuration is called a *SIP peering group*. You configure at least one SIP peering group for every partner and the main principle here is that all servers in a group terminate calls to the same set of listed destinations.

Any SIP peering group is associated with a *contract* for reconciliation and billing purposes and includes two main technical configurations:

- Peering Servers Represent connections to/from your SIP peering's network. The parameters include an IP address and/or a hostname of the remote part. For outbound calls, this is the destination address where to send calls to and for inbound calls it is an IP authorization of the remote server.
- Outbound/Inbound Peering Rules Outbound rules define through which SIP peering group a call from a specific subscriber will be sent for termination to a specific destination.

The example below shows four SIP peering groups with different priorities, callee prefixes (actual destinations offered by this SIP peering) and callee / called patterns (fine-tuning which callee request URIs and caller URIs are allowed through this SIP peering group).

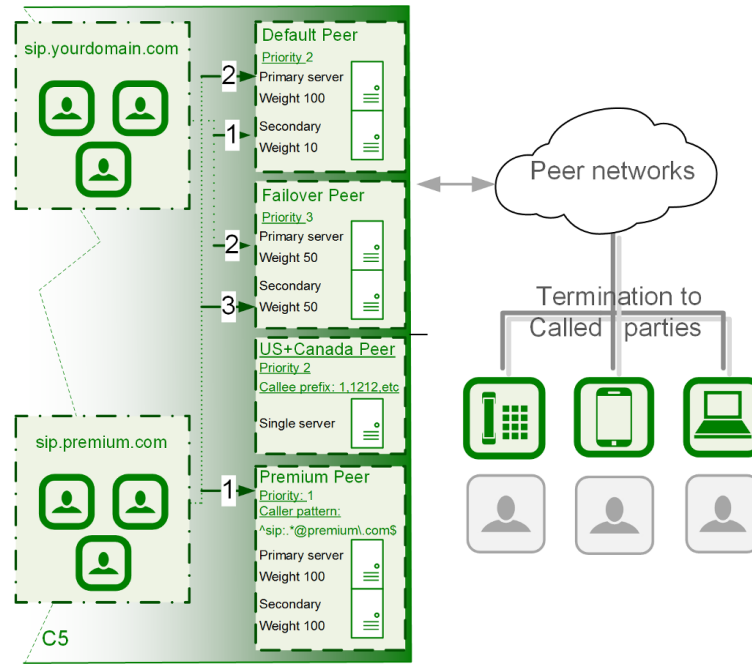

The figure shows how calls from premium subscribers can in the first place be routed through a dedicated SIP peering group unavailable to regular subscribers.

See the [Routing Order Selection](#) section for details about call routing.

Inbound rules allow [filtering out incoming INVITE requests](#) arriving from the corresponding SIP peering servers.

6 VoIP Service Configuration Scenario

A basic VoIP service configuration is fast, easy and straight-forward. Provided that your network and required DNS records have been preconfigured, the configuration of a VoIP service can be done purely via the administrative web interface. The configuration mainly includes the following steps:

- Reseller creation (optional)
- SIP domain configuration
- Customer creation
- Subscribers provisioning

Let us assume you are using the *1.2.3.4* IP address with an associated *sip.yourdomain.com* domain to provision VoIP services. This allows you to provide an easy-to-remember domain name instead of the IP address as the proxy server. Also, your subscribers' URIs will look like *1234567@sip.yourdomain.com*.

Tip

Using an IP address instead of an associated FQDN (domain name) for a SIP domain is not suggested as it could add extra administrative work if you decide to relocate your servers to another datacenter or just change IP addresses.

Go to the *Administrative Web Panel (Admin Panel)* running on *https://<ip>:1443/login/admin* and follow the steps below. The default web panel user and password are *administrator*, if you have not already changed it in [Changing Administrator Password](#).

6.1 Creating a SIP Domain

A SIP domain is a connection point for your subscribers. The SIP domain also contains specific default configuration for all its subscribers.

Tip

Thoroughly plan your domain names policy in advance and take into account that: 1) the name of a SIP domain cannot be changed after creating it in the administrative web panel; 2) subscribers cannot be moved from one domain to another and must be recreated.

To create a SIP domain, follow these steps:

1. Firstly, configure an FQDN on your DNS server for it.

The domain name must point to the physical IP address you are going to use for providing the VoIP service. A good approach is to create an SRV record:

```
SIP via UDP on port 5060
SIP via TCP on port 5060
SIP via TCP/TLS on port 5061
```

2. Create a new SIP domain in the administrative web panel.

Go to the *Domains* page and create a new SIP Domain using the FQDN created above.

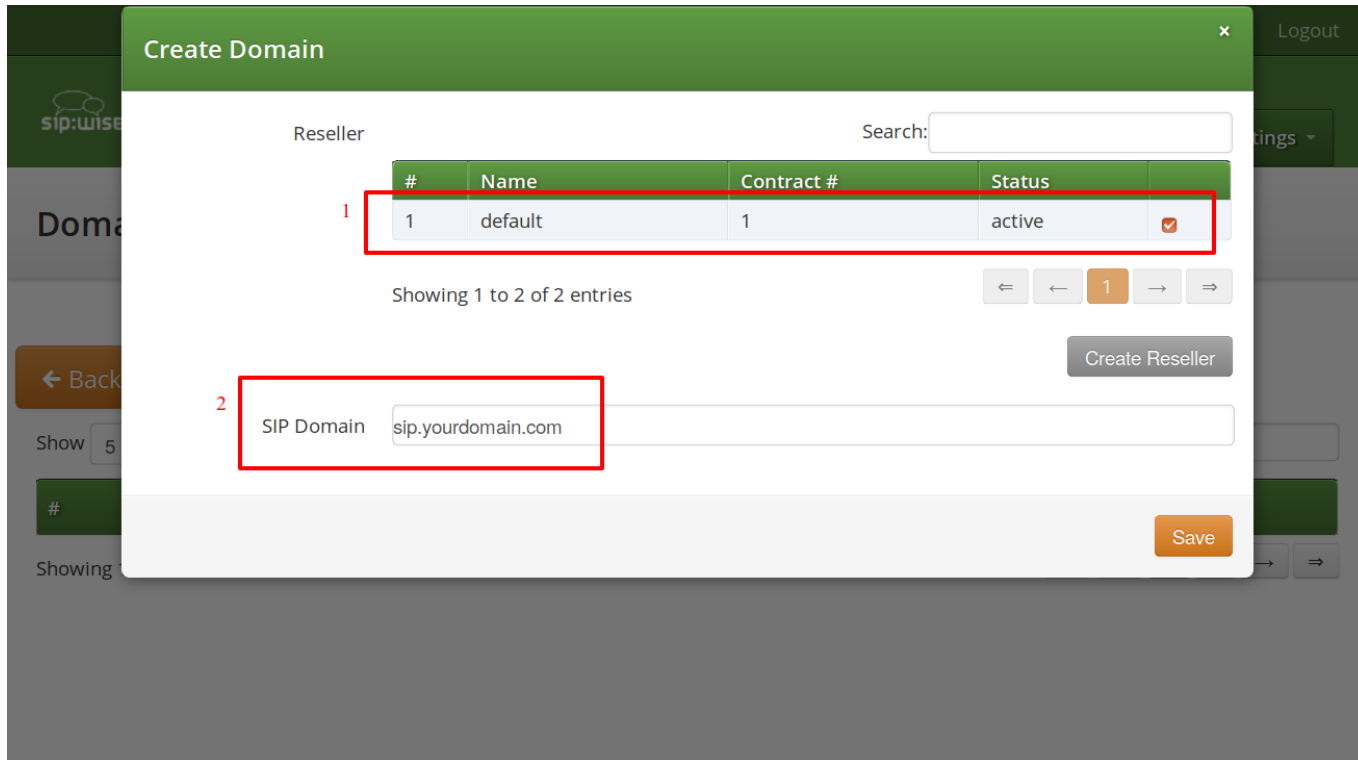

Select a *Reseller* who will own the subscribers in this SIP domain. Use the *default* virtual reseller if you provide services directly. Enter your SIP domain name and press *Save*.

3. Adjust the new SIP domain's preferences if necessary.

You can create multiple SIP domains reusing the existing IP address or adding a new one. Extra SIP domains are required e.g. if you would like to host a virtual operator on your platform, create separate domains for providing services in different countries or just offer a new service.

6.2 Creating a Customer

A Customer is a special type of contract acting as legal and billing information container for SIP subscribers. A customer can have one or more SIP subscriber entities that represent SIP lines.

Tip

For correct billing, notification and invoicing, create a customer with a single SIP subscriber for the residential service (as it normally has only one telephone line) and a customer with multiple SIP subscribers to provide a service to a company with many telephone lines.

To create a Customer, go to *Settings*→*Customers*.

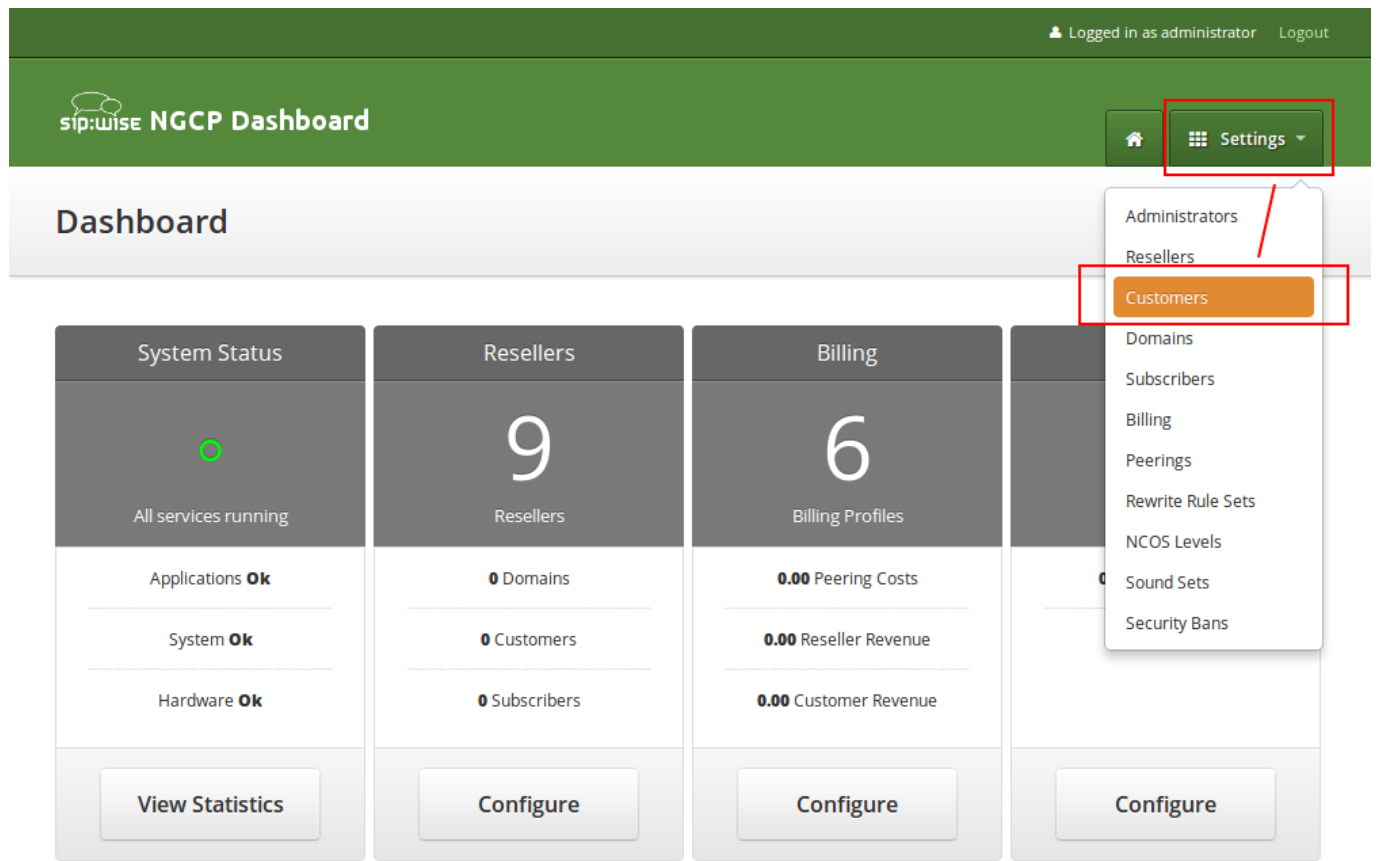

Click on *Create Customer*.

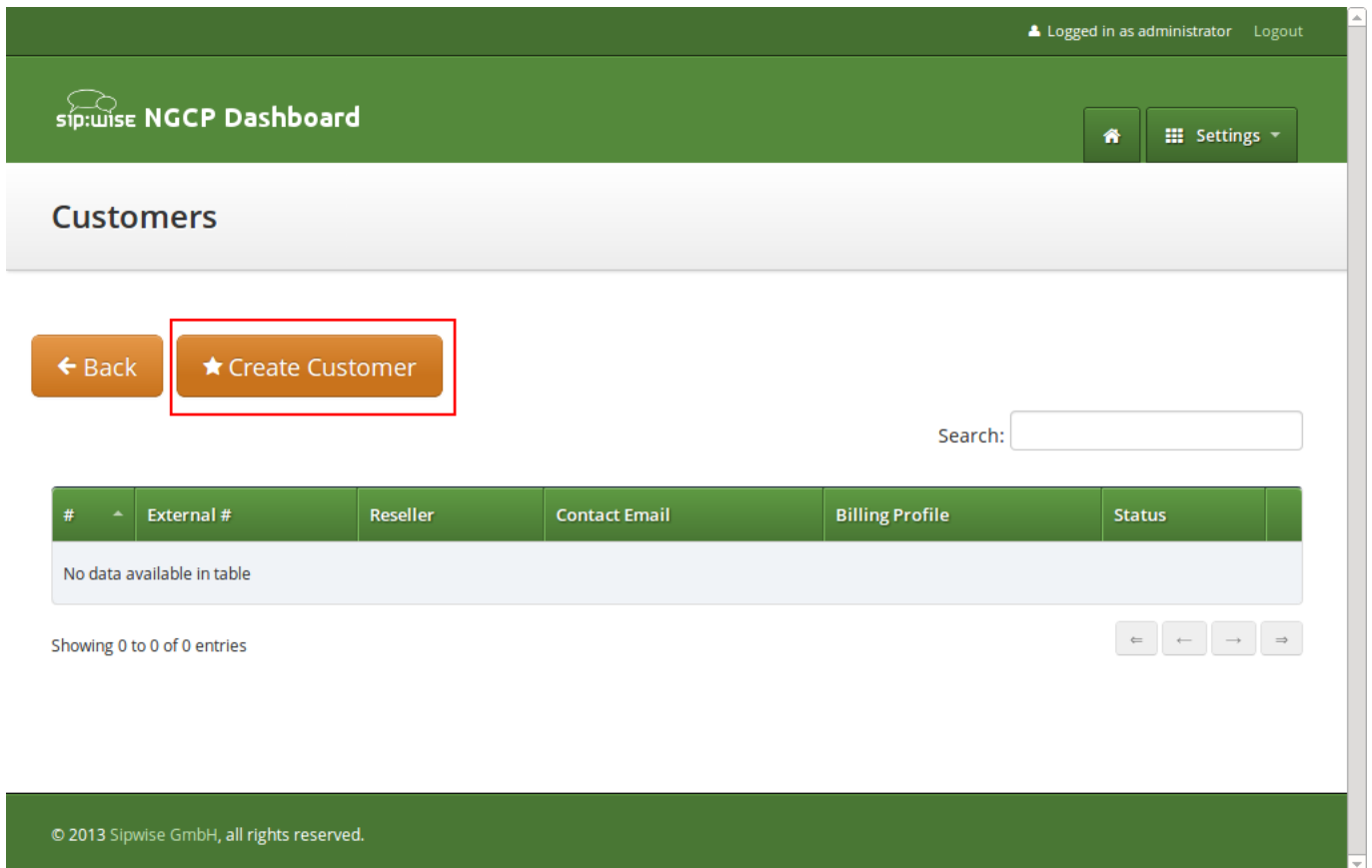

The screenshot shows the NGCP Dashboard interface. At the top right, it indicates the user is logged in as 'administrator' with a 'Logout' link. The dashboard title is 'sip:wise NGCP Dashboard'. Below the title bar, there are navigation buttons for 'Home' and 'Settings'. The main section is titled 'Customers'. Below this title, there are two buttons: 'Back' and 'Create Customer'. The 'Create Customer' button is highlighted with a red rectangular box. To the right of these buttons is a search input field labeled 'Search:'. Below the search field is a table with the following columns: '#', 'External #', 'Reseller', 'Contact Email', 'Billing Profile', and 'Status'. The table is currently empty, displaying the message 'No data available in table'. Below the table, it shows 'Showing 0 to 0 of 0 entries' and a set of pagination controls.

Each *Customer* has a *Contact*—a container for the personal and legal information that identifies a private or corporate customer.

Tip

Create a dedicated *Contact* for every *Customer* as it contains specific data e.g. name, address and IBAN that identifies this customer.

Click on *Create Contact* to create a new *Contact*.

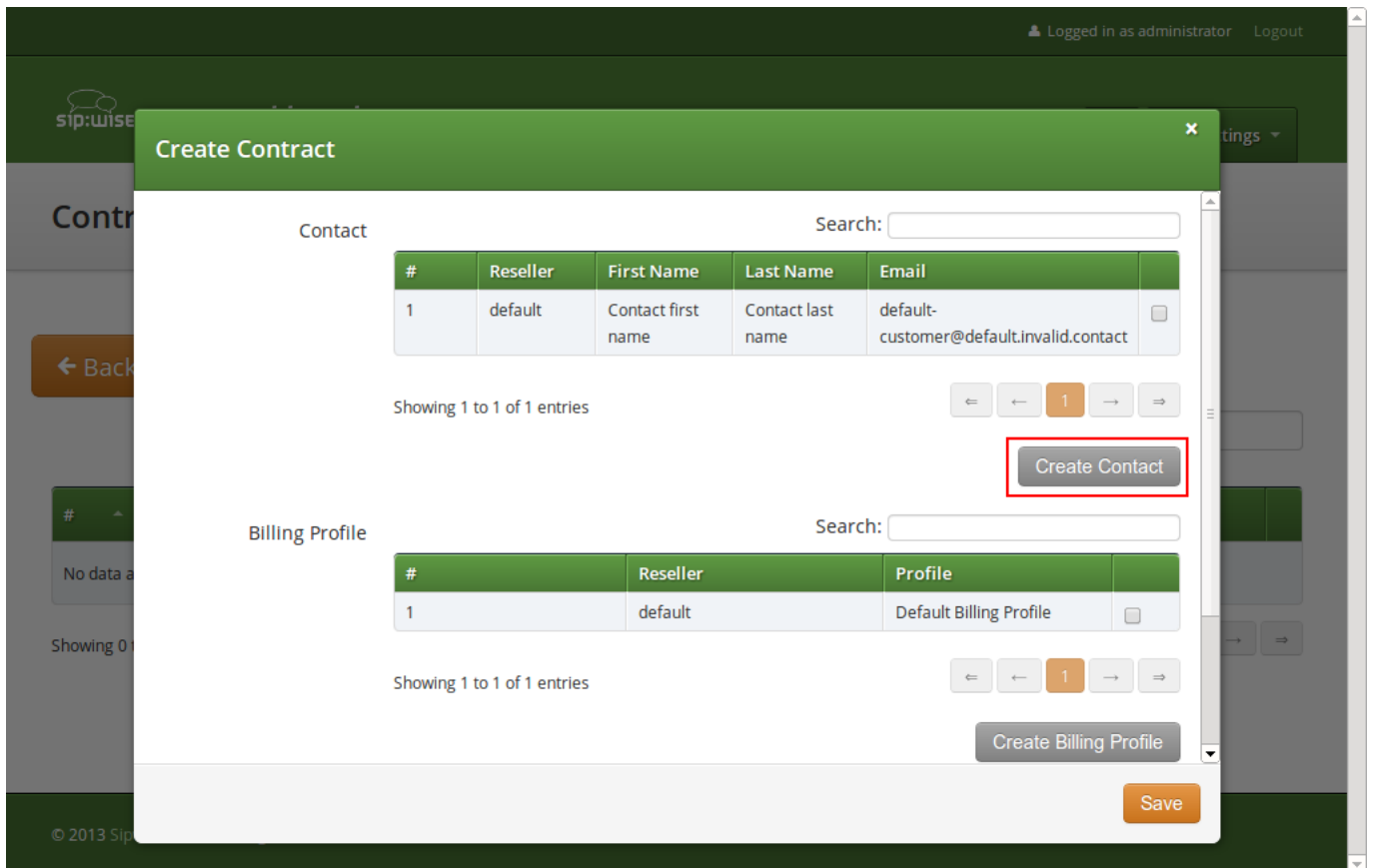

Select the required *Reseller* and enter the contact details (at least an *Email* is required), then press *Save*.

Logged in as administrator Logout

Create Contact

Reseller Search:

#	Name	Contract #	Status	
1	default	1	active	1 <input checked="" type="checkbox"/>

Showing 1 to 1 of 1 entries

Create Reseller

First Name

Last Name

2 Email

Company

3 Save

© 2013 Sipwise

You will be redirected back to the *Customer* form. The newly created *Contact* is selected by default now, so only select a *Billing Profile* and press *Save*.

You will now see your first *Customer* in the list. Hover over the customer and click *Details* to make extra configuration if necessary.

Logged in as administrator Logout

sip:wise NGCP Dashboard

Home Settings

Customers

← Back ★ Create Customer

Contract successfully created

Search:

#	External #	Reseller	Contact Email	Billing Profile	Status	
20		default	myfirstcontact@example.org	Default Billing Profile	active	Edit Terminate Details

Showing 1 to 1 of 1 entries

← 1 →

6.3 Creating a Subscriber

In your *Customer* details view, click on the *Subscribers* row, then click *Create Subscriber*.

Logged in as administrator Logout

sip:wise NGCP Dashboard

Home Settings

Customer Details

← Back Edit

Reseller

Contact Details

Billing Profiles

1 Subscribers

★ Create Subscriber 2

SIP URI	Primary Number	Registered Devices
---------	----------------	--------------------

Contract Balance

Select a *SIP Domain* created earlier and specify required and optional parameters:

- **Domain:** The domain part of the SIP URI for your subscriber.
- **E164 Number:** This is the telephone number mapped to the subscriber, separated into *Country Code (CC)*, *Area Code (AC)* and *Subscriber Number (SN)*. For the first tests, you can set an imaginary number here and change it later when you get number blocks assigned by your PSTN interconnect partner. So in our example, we'll use *43* as CC, *99* as AC and *1001* as SN to form the imaginary number *+43 99 1001*.

Tip

This number can actually be used to place calls between local subscribers, even if you don't have any PSTN interconnection. This comes in handy if you use phones instead of soft-clients for your tests. The format in which this number can be dialled, so the subscriber is reached is defined in Section 6.7.

Important



Sipwise C5 allows a single subscriber to have multiple E.164 numbers to be used as aliases for receiving incoming calls. Also, Sipwise C5 supports so-called "implicit" extensions. If a subscriber has phone number 012345, but somebody calls 012345100, then NGCP first tries to send the call to number 012345100 (even though the user is registered as 012345). If Sipwise C5 then receives the 404 - Not Found response, it falls back to 012345 (the user-part with which the callee is registered).

- **Email:** An email address for sending service-related notifications to.
- **Web Username:** This is the user part of the username the subscriber may use to log into her *Customer Self Care Interface*. The user part will be automatically suffixed by the SIP domain you choose for the **SIP URI**. Usually, the web username is identical to the **SIP URI**, but you may choose a different naming schema.

**Caution**

The web username needs to be unique. The system will return a fault if you try to use the same web username twice.

- **Web Password:** This is the password for the subscriber to log into her *Customer Self Care Interface*. It must be at least 6 characters long.
- **SIP Username:** The user part of the SIP URI for your subscriber.
- **SIP Password:** The password of your subscriber to authenticate on the SIP proxy. It must be at least 6 characters long.
- **Status:** You can lock a subscriber here, but for creating one, you will most certainly want to use the *active* status.
- **External ID:** You can provision an arbitrary string here (e.g. an ID of a 3rd party provisioning/billing system).
- **Administrative:** If you have multiple subscribers in one account and set this option for one of them, this subscriber can administrate other subscribers via the *Customer Self Care Interface*.

Domain Search:

#	Reseller	Domain	
113	default	sip.yourdomain.com	<input checked="" type="checkbox"/>

Showing 1 to 1 of 1 entries

Create Domain

2 E164 Number

3 Email

4 Web Username

5 Web Password

Save

The screenshot shows the 'Create Subscriber' form in the Sipwise NGCP Dashboard. The form is a modal window with a green header. The fields are as follows:

- Web Username: demo
- Web Password: secret
- SIP Username: demo (highlighted with a red box and labeled '6')
- SIP Password: 1secret! (highlighted with a red box and labeled '7')
- Lock Level: none
- Status: active
- External ID: demo
- Administrative:

A 'Save' button is located at the bottom right of the form. The background shows the dashboard navigation menu with options like 'Documentation', 'Monitoring & Statistics', 'Tools', and 'Settings'.

Repeat the creation of *Customers* and *Subscribers* for all your test accounts. You should have at least 3 subscribers to test the functionality of the NGCP.

Tip

At this point, you're able to register your subscribers to Sipwise C5 and place calls between these subscribers.

You should now revise the *Domain* and *Subscriber Preferences*.

6.4 Domain Preferences

The *Domain Preferences* are the default settings for *Subscriber Preferences*, so you should set proper values there if you don't want to configure each subscriber separately. You can later override these settings in the *Subscriber Preferences* if particular subscribers need special settings. To configure your *Domain Preferences*, go to *Settings*→*Domains* and click on the *Preferences* button of the domain you want to configure.

Logged In as administrator Language Logout

Sipwise NGCP Dashboard Documentation Monitoring & Statistics Tools Settings

Domains

← Back ★ Create Domain

Show 5 entries Search:

#	Reseller	Domain	
113	default	sip.yourdomain.com	Delete Preferences

Showing 1 to 1 of 1 entries

The most important settings are in the *Number Manipulations* group.

Here you can configure the following:

- for incoming calls - which SIP message headers to take numbers from
- for outgoing calls - where in the SIP messages to put certain numbers to
- for both - how these numbers are normalized to E164 format and vice versa

To assign a *Rewrite Rule Set* to a *Domain*, create a set first as described in Section 6.7, then assign it to the domain by editing the *rewrite_rule_set* preference.

Domain "sip.yourdomain.com" - Preferences

[← Back](#)

Call Blockings

Access Restrictions

1 **Number Manipulations**

	Name	Value	
?	rewrite_rule_set	<input type="text" value=""/>	2 Edit
?	extension_in_npn	<input type="checkbox"/>	
?	inbound_upn	<input type="text" value="From-Username"/>	
?	outbound_from_user	<input type="text" value="User-Provided-Number"/>	
?	outbound_from_display	<input type="text" value="None"/>	

Select the *Rewrite Rule Set* and press *Save*.

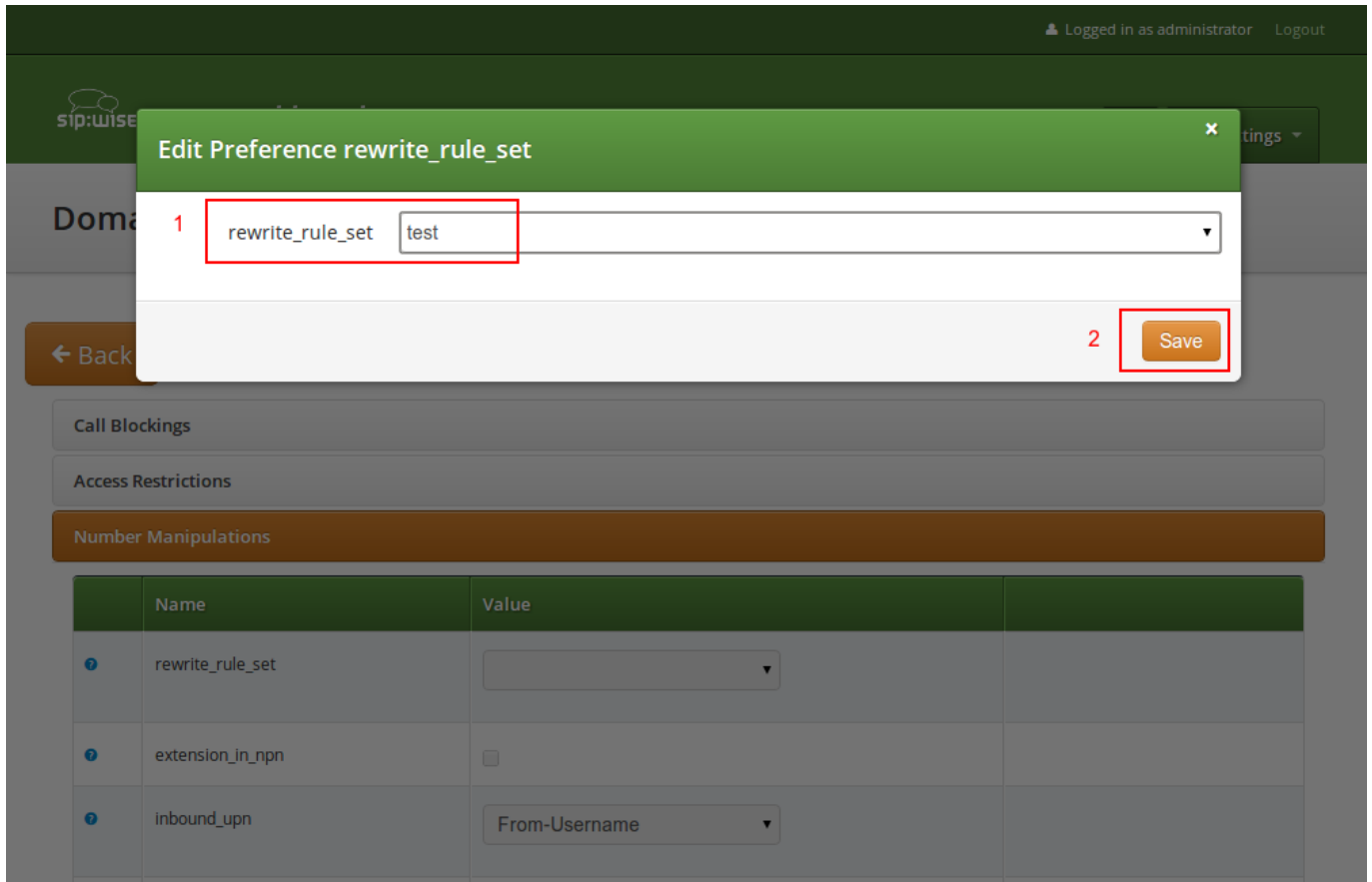

Then, select the field you want the *User Provided Number* to be taken from for inbound INVITE messages. Usually the *From-Username* should be fine, but you can also take it from the *Display-Name* of the From-Header, and other options are available as well.

6.5 Subscriber Preferences

You can override the *Domain Preferences* on a subscriber basis as well. Also, there are *Subscriber Preferences* which don't have a default value in the *Domain Preferences*.

To configure your *Subscriber*, go to *Settings*→*Subscribers* and click *Details* on the row of your subscriber. There, click on the *Preferences* button on top.

You want to look into the *Number Manipulations* and *Access Restrictions* options in particular, which control what is used as user-provided and network-provided calling numbers.

- For outgoing calls, you may define multiple numbers or patterns to control what a subscriber is allowed to send as user-provided calling numbers using the *allowed_clis* preference.
- If *allowed_clis* does not match the number sent by the subscriber, then the number configured in *cli* (the network-provided number) preference will be used as user-provided calling number instead.
- You can override any user-provided number coming from the subscriber using the *user_cli* preference.

Note

Subscribers preference *allowed_clis* will be synchronized with subscribers primary number and aliases if *oss-bss→provisioning→auto_allow_cli* is set to **1** in */etc/ngcp-config/config.yml*.

Note

Subscribers preference *cli* will be synchronized with subscribers primary number if *ossbss→provisioning→auto_sync_cli* is set to **yes** in */etc/ngcp-config/config.yml*.

6.6 Creating Peerings

If you want to terminate calls at or allow calls from 3rd party systems (e.g. PSTN gateways, SIP trunks), you need to create SIP peerings for that. To do so, go to *Settings→Peerings*. There you can add peering groups, and for each peering group add peering servers and rules controlling which calls are routed over these groups. Every peering group needs a peering contract for correct interconnection billing.

6.6.1 Creating Peering Groups

Click on *Create Peering Group* to create a new group.

In order to create a group, you must select a peering contract. You will most likely want to create one contract per peering group.

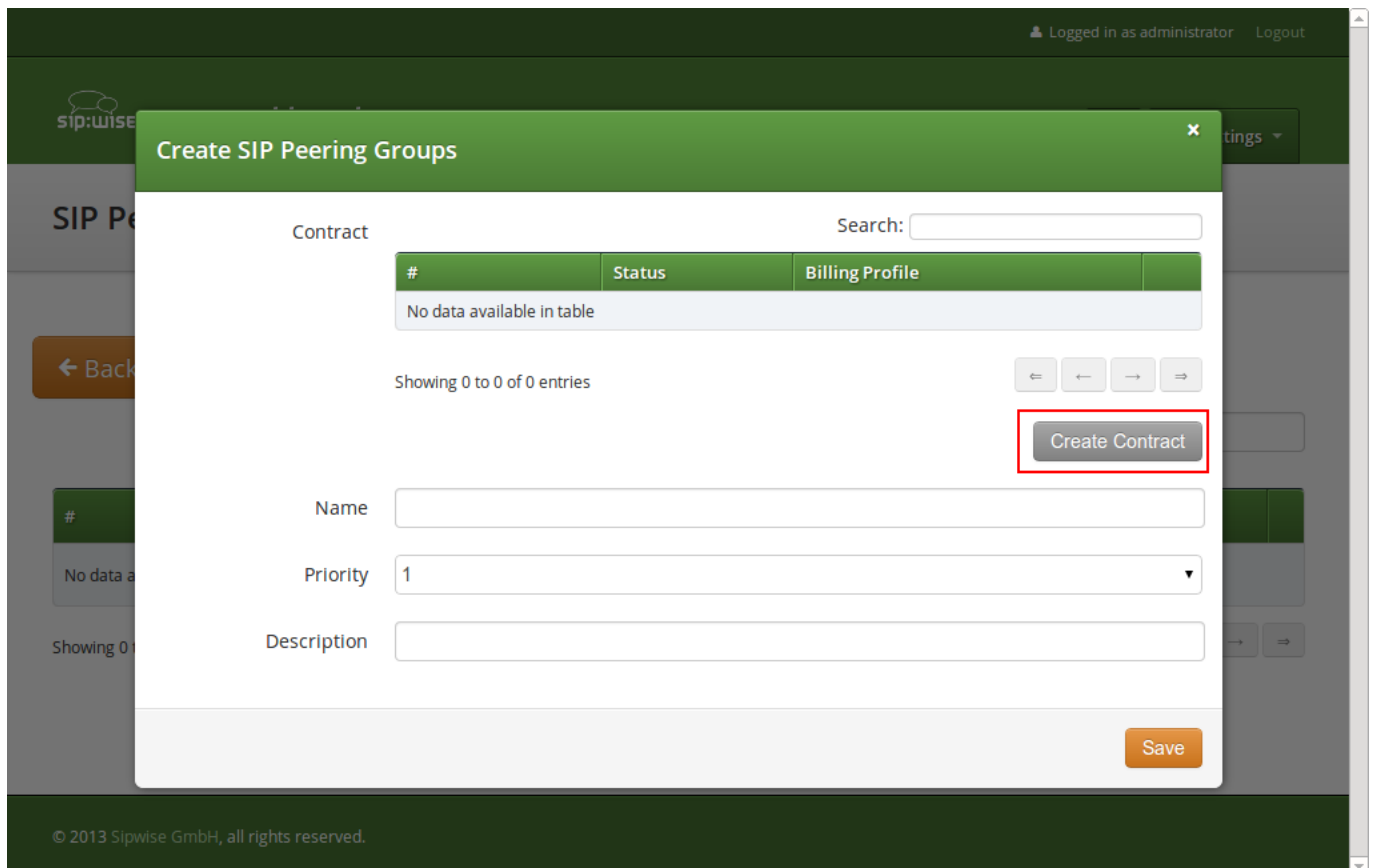

The screenshot shows the 'Create SIP Peering Groups' dialog box in the Sipwise web interface. The dialog is titled 'Create SIP Peering Groups' and has a search bar at the top right. Below the search bar is a table with the following columns: '#', 'Status', and 'Billing Profile'. The table is currently empty, displaying 'No data available in table' and 'Showing 0 to 0 of 0 entries'. A 'Create Contract' button is highlighted with a red box. Below the table are input fields for 'Name', 'Priority' (set to 1), and 'Description'. A 'Save' button is located at the bottom right of the dialog. The background shows the Sipwise web interface with a 'Logged in as administrator' status and a 'Logout' link.

Click on *Create Contract* create a *Contact*, then select a *Billing Profile*.

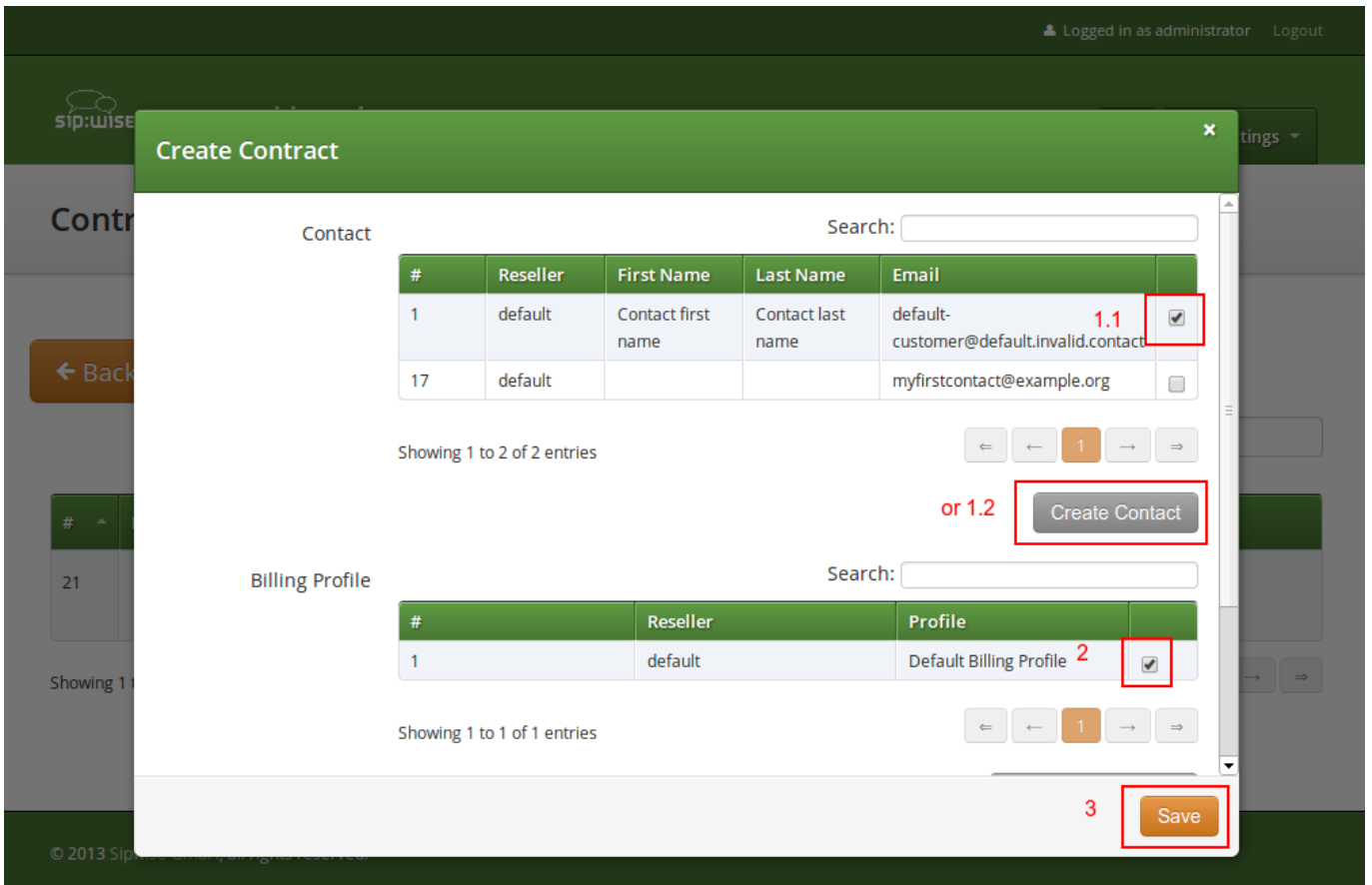

Click *Save* on the *Contacts* form, and you will get redirected back to the form for creating the actual *Peering Group*. Put a name, priority and description there, for example:

- **Peering Contract:** select the id of the contract created before
- **Name:** test group
- **Priority:** 1
- **Description:** peering to a test carrier

The screenshot shows the 'Create SIP Peering Groups' dialog box. At the top, it says 'Contract' and has a search field. Below that is a table with the following data:

#	Status	Billing Profile	
21	active	Default Billing Profile	1 <input checked="" type="checkbox"/>

Below the table, it says 'Showing 1 to 1 of 1 entries' and has navigation buttons. There is a 'Create Contract' button. Below the table are three input fields:

- 2 Name: test group
- 3 Priority: 1
- 4 Description: peering to a test carrier

At the bottom right, there is a 'Save' button.

The *Priority* option defines which *Peering Group* to favor (Priority 1 gives the highest precedence) if two peering groups have peering rules matching an outbound call. *Peering Rules* are described below.

Then click *Save* to create the group.

6.6.2 Creating Peering Servers

In the group created before, you need to add peering servers to route calls to and receive calls from. To do so, click on *Details* on the row of your new group in your peering group list.

To add your first *Peering Server*, click on the *Create Peering Server* button.

Peering Servers

Show 5 entries Search:

#	Name	IP Address	Hostname	Port	Protocol	Weight	Via Route Set	Enabled
No data available in table								

Showing 0 to 0 of 0 entries ← ← → →

Outbound Peering Rules

ANY of the rules must match to choose the peering group for outbound calls.

Show 5 entries Search:

#	Callee Prefix	Callee Pattern	Caller Pattern	Description	Enabled
No data available in table					

Showing 0 to 0 of 0 entries ← ← → →

Inbound Peering Rules

ALL of the rules must match to choose the peering group for inbound calls.

Show 5 entries Search:

Priority	#	Field	Pattern	Reject Code	Reject Reason	Enabled
No data available in table						

Showing 0 to 0 of 0 entries ← ← → →

Figure 10: Create Peering Server

In this example, we will create a peering server with IP 2.3.4.5 and port 5060:

- **Name:** test-gw-1
- **IP Address:** 2.3.4.5
- **Hostname:** leave empty
- **Port:** 5060
- **Protocol:** UDP
- **Weight:** 1
- **Via Route:** None

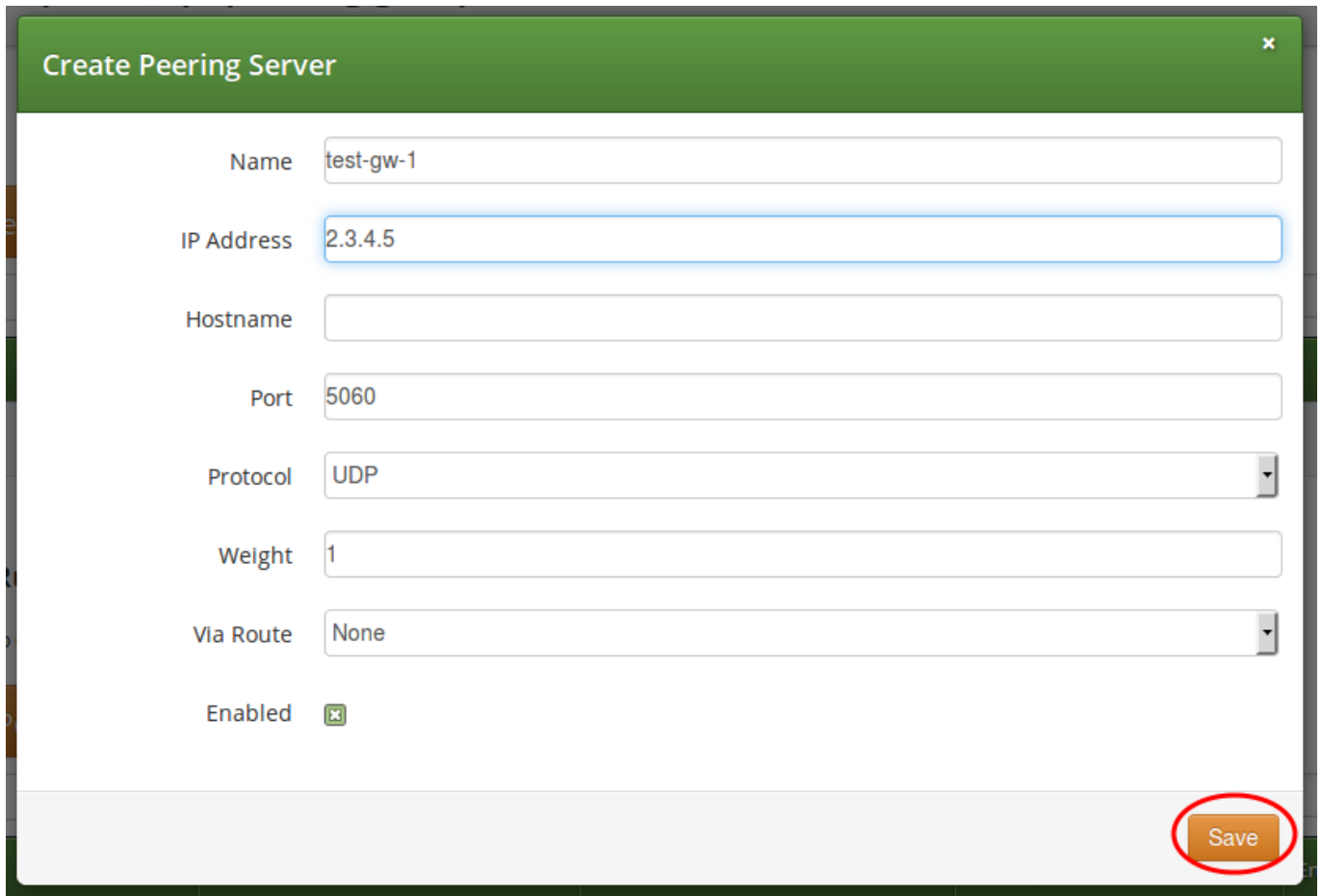

The screenshot shows a 'Create Peering Server' dialog box with the following fields and values:

- Name: test-gw-1
- IP Address: 2.3.4.5
- Hostname: (empty)
- Port: 5060
- Protocol: UDP
- Weight: 1
- Via Route: None
- Enabled:

A 'Save' button is located at the bottom right of the dialog, circled in red.

Figure 11: Peering Server Properties

Click **Save** to create the peering server.

Tip

The *hostname* field for a peering server is optional. Usually, the IP address of the peer is used as the **domain** part of the Request URI. Fill in this field if a peer requires a particular hostname instead of the IP address. The IP address must always be given though as it is used for the selection of the inbound peer. By default outbound requests will always be sent to the specified IP address, no matter what you put into the *hostname* field. If you want to send the request using the DNS resolution of the configured *hostname*, disregarding in that way the IP, you have to enable `outbound_hostname_resolution` option in peer preferences.

Tip

If you want to add a peering server with an IPv6 address, enter the address without surrounding square brackets into the *IP Address* column, e.g. `::1`.

You can force an additional hop (e.g. via an external SBC) towards the peering server by using the *Via Route* option. The available options you can select there are defined in `/etc/ngcp-config/config.yml`, where you can add an array of SIP URIs in

kamailio→lb→external_sbc like this:

```
kamailio:
  lb:
    external_sbc:
      - sip:192.168.0.1:5060
      - sip:192.168.0.2:5060
```

Execute `ngcpcfg apply "added external sbc gateways"`, then edit your peering server and select the hop from the *Via Route* selection.

Once a peering server has been created, this server can already send calls to the system.

6.6.2.1 Outbound Peering Rules



Important

To be able to send outbound calls towards the servers in the *Peering Group*, you also need to define *Outbound Peering Rules*. They specify which source and destination numbers are going to be terminated over this group. To create a rule, click the *Create Outbound Peering Rule* button.

Peering Servers

[← Back](#)
[★ Create Peering Server](#)

Peering server successfully created

Show 5 entries Search:

#	Name	IP Address	Hostname	Port	Protocol	Weight	Via Route Set	Enabled
29	test-gw-1	2.3.4.5		5060	1	1		1

Showing 1 to 1 of 1 entries ← ← 1 → →

Outbound Peering Rules

ANY of the rules must match to choose the peering group for outbound calls.

[★ Create Outbound Peering Rule](#)

Show 5 entries Search:

#	^	Callee Prefix	Callee Pattern	Caller Pattern	Description	Enabled
No data available in table						

Showing 0 to 0 of 0 entries ← ← → →

Inbound Peering Rules

ALL of the rules must match to choose the peering group for inbound calls.

[★ Create Inbound Peering Rule](#)

Figure 12: Create Outbound Peering Rule

Since the previously created peering group will be the only one in our example, we have to add a default rule to route *all* calls via this group. To do so, create a new peering rule with the following values:

- **Callee Prefix:** leave empty
- **Callee Pattern:** leave empty
- **Caller Pattern:** leave empty
- **Description:** Default Rule

The screenshot shows a dialog box titled "Create Outbound Peering Rule". It features a green header bar with a close button (X) in the top right corner. The main content area is white and contains four input fields stacked vertically: "Callee prefix", "Callee pattern", "Caller pattern", and "Description". The "Description" field is highlighted with a red oval and contains the text "Default rule". Below these fields is an "Enabled" checkbox, which is checked. At the bottom right of the dialog, there is a "Save" button, also highlighted with a red oval. The dialog is set against a dark background, likely a window or application interface.

Figure 13: Outbound Peering Rule Properties

Then click *Save* to add the rule to your group.

Tip

In contrast to the callee/caller pattern, the callee prefix has a regular alphanumeric string and can not contain any regular expression.

Tip

If you set the caller or callee rules to refine what is routed via this peer, enter all phone numbers in full E.164 format, that is `<cc><ac><sn>`.

Tip

The *Caller Pattern* field covers the whole URI including the subscriber domain, so you can only allow certain domains over this peer by putting for example `@example\.com` into this field.

6.6.2.2 Inbound Peering Rules

Starting from *mr5.0* release, Sipwise C5 supports filtering SIP INVITE requests sent by SIP peers. The system administrator may define one or more matching rules for SIP URIs that are present in the headers of SIP INVITE requests, and select which SIP header (or part of the header) must match the pattern declared in the rule.

If the incoming SIP INVITE message has the proper headers, Sipwise C5 will accept and further process the request. If the message does not match the rule it will be rejected.



Caution

An incoming SIP INVITE message must match **all the inbound peering rules** so that Sipwise C5 does not reject the request.

In order to **create an inbound peering rule** you have to select a peering group, press *Details* and then press *Create Inbound Peering Rule* button.

Peering Servers

← Back
★ Create Peering Server

Show 5 entries Search:

#	Name	IP Address	Hostname	Port	Protocol	Weight	Via Route Set	Enabled
29	test-gw-1	2.3.4.5		5060	1	1		1

Showing 1 to 1 of 1 entries ← ← 1 → →

Outbound Peering Rules

ANY of the rules must match to choose the peering group for outbound calls.

★ Create Outbound Peering Rule

Show 5 entries Search:

#	Callee Prefix	Callee Pattern	Caller Pattern	Description	Enabled
1				Default rule	1

Showing 1 to 1 of 1 entries ← ← 1 → →

Inbound Peering Rules

ALL of the rules must match to choose the peering group for inbound calls.

★ Create Inbound Peering Rule

Show 5 entries Search:

Priority	#	Field	Pattern	Reject Code	Reject Reason	Enabled
No data available in table						

Showing 0 to 0 of 0 entries ← ← → →

Figure 14: Create Inbound Peering Rule

An inbound peering rule has the following **properties**:

Figure 15: Inbound Peering Rule Properties

- `Match Field`: select which header and which part of that header in a SIP INVITE message will be checked for matching the pattern
- `Pattern`: a POSIX regular expression that defines the accepted value of a header; example: `^sip:.*@example\.org$` — this will match a SIP URI that contains "example.org" in the domain part
- `Reject code`: optional; a SIP status code that will be sent as a response to an INVITE request that does not match the pattern; example: 403
- `Reject reason`: optional; an arbitrary text that will be included in the SIP response sent with the *reject code*
- `Enabled`: a flag to enable / disable the particular inbound peering rule

Note

Both of the properties `Reject code` and `Reject reason` must be left empty if a peering server (i.e. a specific IP address) is part of more peering groups. Such a configuration is useful when an incoming SIP INVITE request needs to be treated differently in the affected peering groups, based on its content, and that's why if the INVITE message only partly matches an inbound peering rule it should not simply be rejected.

When all settings for a peering group are done the details of the group look like:

Peering Servers

[← Back](#)
[★ Create Peering Server](#)

Show entries Search:

#	Name	IP Address	Hostname	Port	Protocol	Weight	Via Route Set	Enabled
29	test-gw-1	2.3.4.5		5060	1	1		1

Showing 1 to 1 of 1 entries ← ← 1 → →

Outbound Peering Rules

ANY of the rules must match to choose the peering group for outbound calls.

[★ Create Outbound Peering Rule](#)

Show entries Search:

#	Callee Prefix	Callee Pattern	Caller Pattern	Description	Enabled
1				Default rule	1

Showing 1 to 1 of 1 entries ← ← 1 → →

Inbound Peering Rules

ALL of the rules must match to choose the peering group for inbound calls.

[★ Create Inbound Peering Rule](#)

Show entries Search:

Priority	#	Field	Pattern	Reject Code	Reject Reason	Enabled
50	1	to_domain	example\org	403	Invalid called party domain	1

Showing 1 to 1 of 1 entries ← ← 1 → →

Figure 16: Peering Servers Overview

6.6.2.3 Routing Order Selection

The selection of peering groups and peering servers for outgoing calls is done in the following way:

- All peering groups that meet the following criteria configured in the outbound peering rule are added to the list of routes for a particular call:
 - Callee's username matches *callee prefix*
 - Callee's URI matches *callee pattern*
 - Caller's URI matches *caller pattern*
- When all matching peering groups are selected, they are ordered by *callee prefix* according to the **longest match basis** (sometimes referred to as the **longest pattern match** or **maximum pattern length match**). One or more peering group with longest *callee prefix* match will be given first positions on the list of routes.

3. Peering groups with the same *callee prefix* length are further ordered by **Priority**. Peering group(s) with the higher priorities will occupy higher positions.



Important

Priority **1** gives the *highest* precedence to the corresponding peering group. Hence, a lower priority value will put the peering group higher in the list of routes (compared to other peering groups with the same *callee prefix* length).

Priority can be selected from **1** (highest) to **9** (lowest).

4. All peering servers in the peering group with the highest priority (e.g. priority **1**) are tried one-by-one starting from the highest server weight. Peering groups with lower priorities or with shorter *callee prefix* will be used only for fail-over.

The **weight** of the peering servers in the selected peering group will influence the order in which the servers within the group will be tried for routing the outbound call. The weight of a server can be set in the range from **1** to **127**.



Important

Opposite to the peering group priority, a peering server with a higher weight value has a *higher* precedence, but the server weight rather sets a probability than a strict order. E.g. although a peering server with weight **127** has the highest chance to be the first in the list of routes, another server with a lower weight (e.g. **100**) sometimes will be selected first.

In order to find out this probability knowing the weights of peering servers, use the following script:

```
#!/usr/bin/perl

#This script can be used to find out actual probabilities
#that correspond to a list of peering weights.

$num_args = $#ARGV + 1;
if ($num_args < 1) {
    print "Usage: lcr_weight_test.pl <list of weights (integers 1-254)>\n";
    exit 0;
}

my $iters = 10000;
my @rands;

for (my $i=1; $i <= $iters; $i++) {
    my %elem;
    for (my $j=0; $j < $num_args; $j++) {
        my $random = int(rand(2000000000));
        $elem{"$j"} = $ARGV[$j] * $random;
    }
    push(@rands, \%elem);
}
```

```

}

my @counts;
for (my $j=0; $j < $num_args; $j++) {
    $counts["$j"] = 0;
}

foreach my $rand (@rands) {
    my $higher = 0;
    my $higher_key = 0;
    foreach $key (keys %{$rand}) {
        if ($rand->{$key} > $higher) {
            $higher = $rand->{$key};
            $higher_key = $key;
        }
    }
    $counts[$higher_key]++;
}

for (my $j=0; $j < $num_args; $j++) {
    my $prob = $counts[$j]/$iters;
    print "Peer with weight $ARGV[$j] has probability $prob \n";
}

```

Let us say you have 2 peering servers, one with weight 1 and another with weight 2. At the end—running the script as below—you will have the following traffic distribution:

```

# lcr_weight_test.pl 1 2

Peer with weight 1 has probability 0.2522
Peer with weight 2 has probability 0.7478

```

If a peering server replies with SIP codes 408, 500 or 503, or if a peering server doesn't respond at all, the next peering server in the current peering group is tried as a fallback. All the servers within the group are tried one after another until the call succeeds. If no more servers are left in the current peering group, the next group which matches the outbound peering rules is used.

Note

The Sipwise C5 may use a slightly different approach in selecting the appropriate peering server if the *peer probing* feature is enabled. See the details in Section 7.11 of the handbook.

6.6.2.4 Least Cost Routing (LCR) Configuration

The default call routing uses statically configured peering group priorities to decide where to send the calls. This solution is useful when you have an external SBC that makes all the routing decisions and is described in the [Routing Order Selection](#) section.

Sipwise C5 also allows you routing calls to the cheapest SIP peers saving your termination cost.

To enable LCR routing, do the following:

- Upload the billing fees provided by your peers to the corresponding peering billing profiles
- Enable the LCR module in config.yml (kamailio.proxy.perform_peer_lcr: yes)

When the LCR routing is enabled, the selection of peering groups would be the following:

1. All peering groups that meet the following criteria configured in the outbound peering rule are added to the list of routes for a particular call (for pure LCR you might want to omit these filters leaving them blank):
 - Callee's username matches *callee prefix*
 - Callee's URI matches *callee pattern*
 - Caller's URI matches *caller pattern*
2. When all matching peering groups are selected, the longest matching *callee prefix* is selected from each of them. And the peering groups are *temporary* ordered according to the longest matching prefix and priority.
3. Then, the LCR module re-orders the peering groups starting from the lowest termination cost to the highest (ignoring the prefix length and peering group priorities).
4. The platform will first route the call to the servers of the first peering group in this list. If no peering server can terminate the call, the call would fail-over to the second peering group from the list and so on.

Note

The peering servers in every peering group are sorted and tried according to their weight as described in the previous section.

Let us consider a short example. There are two peering groups (PG1 and PG2) that can deliver calls to New York (e.g. 12121234567) and they have the following rates:

Peering Group	Prefix	Cost	Description
PG1	1	0.02	USA & Canada
PG2	1	0.05	USA & Canada
	1212	0.03	New York, USA

PG1 has only one rate that matches the dialed number, so that it will be taken into account, PG2 has two rates and the longest will be selected. The call will be routed to PG1 servers first as it has a cheaper price and can fail-over to PG2 servers.

The Sipwise C5 LCR feature together with the codec filtering, media transcoding, header manipulations, SIP, and RTP encryption and other SBC features make an external SBC unnecessary. This simplifies your VoIP network and cuts deployment and operation costs.

6.6.3 Authenticating and Registering against Peering Servers

6.6.3.1 Proxy-Authentication for outbound calls

If a peering server requires Sipwise C5 to authenticate for outbound calls (by sending a 407 as response to an INVITE), then you have to configure the authentication details in the *Preferences* view of your peer host.

Peering Servers

← Back ★ Create Peering Server

Show 5 entries Search:

#	Name	IP Address	Hostname	Port	Protocol	Weight	Via Route Set	Enabled	
29	test-gw-1	2.3.4.5		5060	1	1		1	<a>Edit <a>Delete <a>Preferences

Showing 1 to 1 of 1 entries

Outbound Peering Rules

ANY of the rules must match to choose the peering group for outbound calls.

★ Create Outbound Peering Rule

Show 5 entries Search:

#	Callee Prefix	Callee Pattern	Caller Pattern	Description	Enabled	
1				Default rule	1	

Showing 1 to 1 of 1 entries

Inbound Peering Rules

ALL of the rules must match to choose the peering group for inbound calls.

★ Create Inbound Peering Rule

Figure 17: Select Peering Server Preferences

To configure this setting, open the *Remote Authentication* tab and edit the following three preferences:

- **peer_auth_user:** <username for peer auth>
- **peer_auth_pass:** <password for peer auth>
- **peer_auth_realm:** <domain for peer auth>

← Back



Preference peer_auth_realm successfully updated.

Access Restrictions

Number Manipulations

NAT and Media Flow Control

Remote Authentication

	Name	Value	
	peer_auth_user 1	peeruser1	
	peer_auth_pass 2	peerpass1	
	peer_auth_realm 3	testpeering.com	
	peer_auth_register	<input type="checkbox"/>	
	find_subscriber_by_uuid	<input type="checkbox"/>	

Session Timers

Important



If you do NOT authenticate against a peer host, then the caller CLI is put into the From and P-Asserted-Identity headers, e.g. "+4312345" <sip:+4312345@your-domain.com>. If you DO authenticate, then the From header is "+4312345" <sip:your_peer_auth_user@your_peer_auth_realm> (the CLI is in the Display field, the peer_auth_user in the From username and the peer_auth_realm in the From domain), and the P-Asserted-Identity header is as usual like <sip:+4312345@your-domain.com>. So for presenting the correct CLI in *CLIP no screening* scenarios, your peering provider needs to extract the correct user either from the From Display-Name or from the P-Asserted-Identity URI-User.

Tip

If **peer_auth_realm** is set, the system may overwrite the Request-URI with the peer_auth_realm value of the peer when sending the call to that peer or peer_auth_realm value of the subscriber when sending a call to the subscriber. Since this is rarely a desired behavior, it is disabled by default starting with Sipwise C5 release 3.2. If you need the replacement, you should set `set_ruri_to_peer_auth_realm: 'yes'` in `/etc/ngcp-config/config.yml`.

6.6.3.2 Registering at a Peering Server

Unfortunately, the credentials configured above are not yet automatically used to register Sipwise C5 at your peer hosts. There is however an easy manual way to do so, until this is addressed.

Configure your peering servers with the corresponding credentials in `/etc/ngcp-config/templates/etc/ngcp-sems/etc/reg_agent.conf.tt2`, then execute `ngcpcfg apply "added upstream credentials"`.



Important

Be aware that this will force SEMS to restart, which will drop all calls.

6.7 Configuring Rewrite Rule Sets

On the NGCP, every phone number is treated in E.164 format `<country code><area code><subscriber number>`. Rewrite Rule Sets is a flexible tool to translate the caller and callee numbers to the proper format before the routing lookup and after the routing lookup separately. The created Rewrite Rule Sets can be assigned to the domains, subscribers and peers as a preference. Here below you can see how the Rewrite Rules are used by the system:

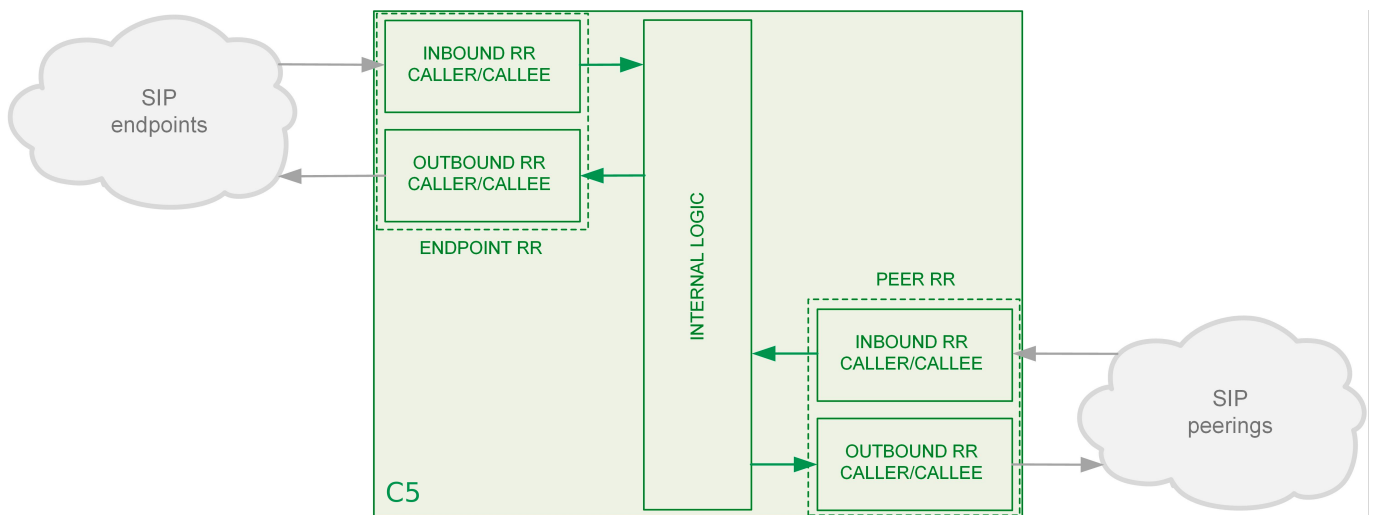

As from the image above, following the arrows, you will have an idea about which type of Rewrite Rules are applied during a call. In general:

- Call from local subscriber A to local subscriber B: Inbound RR from local Domain/Subscriber A and Outbound Rewrite Rules from local Domain/Subscriber B.
- Call from local subscriber A to the peer: Inbound RR from local Domain/Subscriber A and Outbound Rewrite Rules from the peer.
- Call from peer to local subscriber B: Inbound RR from the Peer and Outbound Rewrite Rules from local Domain/Subscriber B.

You would normally begin with creating a Rewrite Rule Set for your SIP domains. This is used to control what an end user can dial for outbound calls, and what is displayed as the calling party on inbound calls. The subscribers within a domain inherit Rewrite Rule Sets of that domain, unless this is overridden by a subscriber Rewrite Rule Set preference.

You can use several special variables in the Rewrite Rules, below you can find a list of them. Some examples of how to use them are also provided in the following sections:

- `${caller_cc}` : This is the value taken from the subscriber's preference CC value under Number Manipulation
- `${caller_ac}` : This is the value taken from the subscriber's preference AC value under Number Manipulation
- `${caller_emergency_cli}` : This is the value taken from the subscriber's preference emergency_cli value under Number Manipulation
- `${caller_emergency_prefix}` : This is the value taken from the subscriber's preference emergency_prefix value under Number Manipulation
- `${caller_emergency_suffix}` : This is the value taken from the subscriber's preference emergency_suffix value under Number Manipulation

To create a new Rewrite Rule Set, go to *Settings*→*Rewrite Rule Sets*. There you can create a Set identified by a name. This name is later shown in your peer-, domain- and user-preferences where you can select the rule set you want to use.

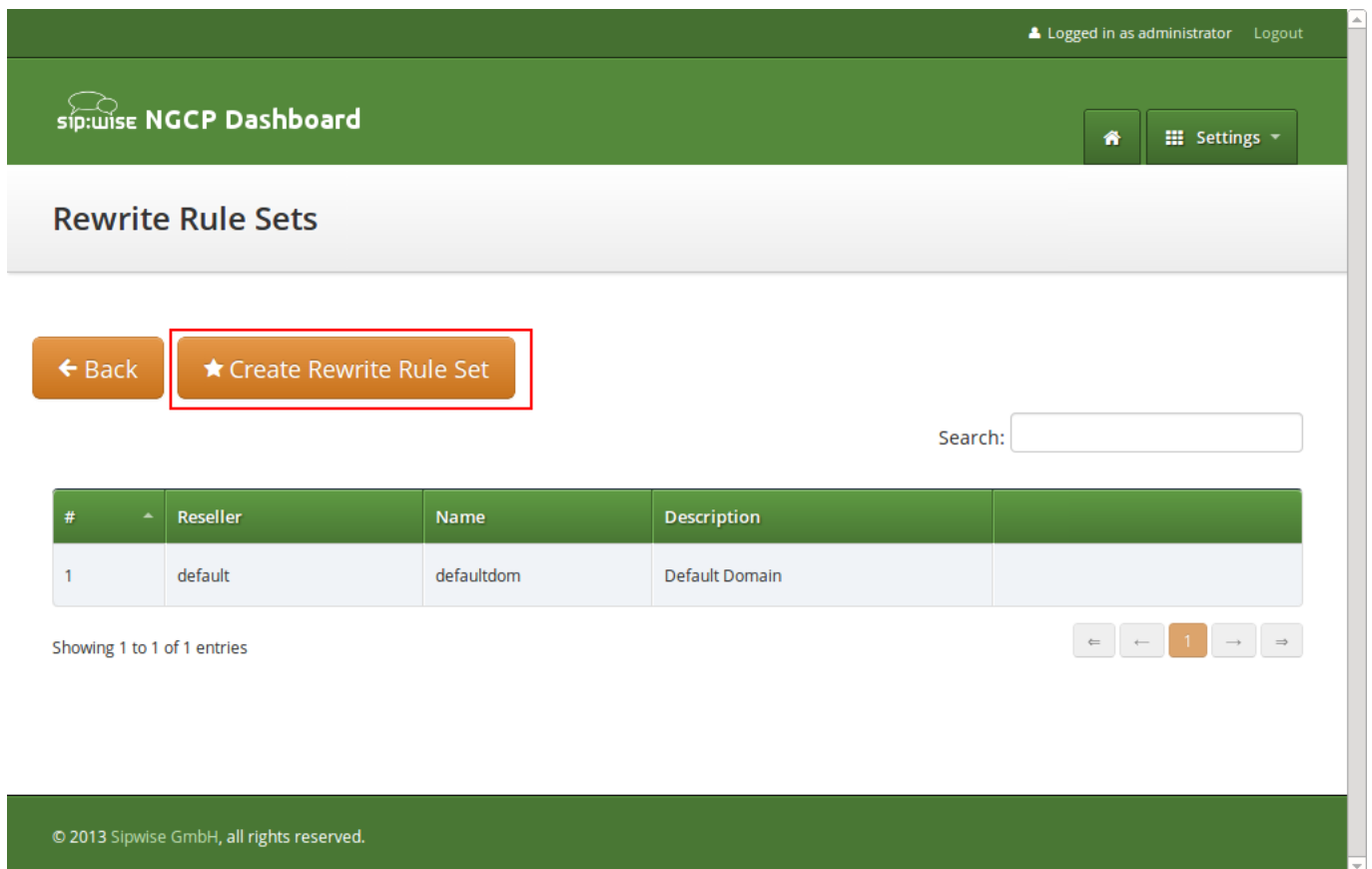

The screenshot shows the Sipwise NGCP Dashboard interface. At the top, it says "Logged in as administrator" and "Logout". The dashboard title is "sip:wise NGCP Dashboard". Below the title, there are navigation buttons for "Home" and "Settings". The main heading is "Rewrite Rule Sets".

Below the heading, there are two buttons: "Back" and "Create Rewrite Rule Set". The "Create Rewrite Rule Set" button is highlighted with a red box. To the right of these buttons is a search input field labeled "Search:".

Below the search field is a table with the following data:

#	Reseller	Name	Description
1	default	defaultdom	Default Domain

Below the table, it says "Showing 1 to 1 of 1 entries". There are also pagination controls showing "1" in an orange box, indicating the current page.

At the bottom of the dashboard, there is a footer: "© 2013 Sipwise GmbH, all rights reserved."

Click *Create Rewrite Rule Set* and fill in the form accordingly.

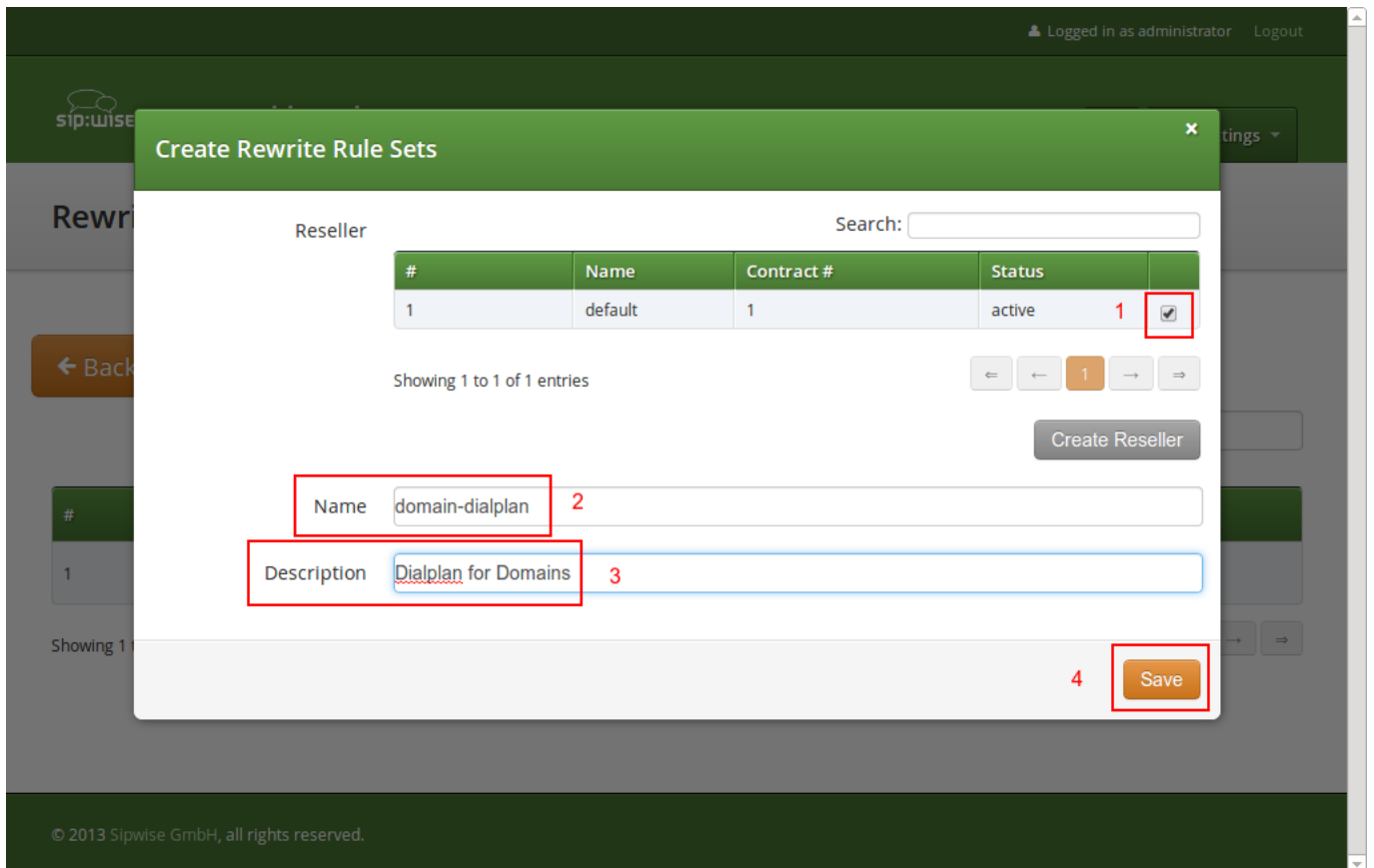

Press the *Save* button to create the set.

To view the *Rewrite Rules* within a set, hover over the row and click the *Rules* button.

Logged in as administrator Logout

sip:wise NGCP Dashboard

Home Settings

Rewrite Rule Sets

Back Create Rewrite Rule Set

Rewrite rule set successfully created

Search:

#	Reseller	Name	Description	
1	default	defaultdom	Default Domain	
2	default	domain-dialplan	Dialplan for Domains	Edit Delete Rules

Showing 1 to 2 of 2 entries

← 1 →

The rules are ordered by *Caller* and *Callee* as well as direction *Inbound* and *Outbound*.

Tip

In Europe, the following formats are widely accepted: $+<cc><ac><sn>$, $00<cc><ac><sn>$ and $0<ac><sn>$. Also, some countries allow the areacode-internal calls where only subscriber number is dialed to reach another number in the same area. Within this section, we will use these formats to show how to use rewrite rules to normalize and denormalize number formats.

6.7.1 Inbound Rewrite Rules for Caller

These rules are used to normalize user-provided numbers (e.g. passed in *From Display Name* or *P-Preferred-Identity* headers) into E.164 format. In our example, we'll normalize the three different formats mentioned above into E.164 format.

To create the following rules, click on the *Create Rewrite Rule* for each of them and fill them with the values provided below.

STRIP LEADING 00 OR +

- Match Pattern: $^(00|\+)([1-9][0-9]+)\$$
- Replacement Pattern: $\2$
- Description: International to E.164
- Direction: Inbound

- Field: Caller

REPLACE 0 BY CALLER'S COUNTRY CODE:

- Match Pattern: `^0([1-9][0-9]+)$`
- Replacement Pattern: `${caller_cc}\1`
- Description: National to E.164
- Direction: Inbound
- Field: Caller

NORMALIZE LOCAL CALLS:

- Match Pattern: `^([1-9][0-9]+)$`
- Replacement Pattern: `${caller_cc}${caller_ac}\1`
- Description: Local to E.164
- Direction: Inbound
- Field: Caller

The screenshot shows the 'Create Rule' dialog box in the Sipwise interface. The dialog is a white box with a green header 'Create Rule' and a close button 'x'. It contains several fields: 'Match pattern' with the value '^([00|+)([1-9][0-9]+)\$' and a red box around it labeled '1'; 'Replacement Pattern' with the value '\2' and a red box around it labeled '2'; 'Description' with the value 'International to E.164' and a red box around it labeled '3'; 'Direction' with the value 'Inbound' and a red box around it labeled '4'; 'Field' with the value 'Caller' and a red box around it labeled '5'; and a 'Save' button at the bottom right with a red box around it labeled '6'. The background shows a blurred interface with a 'Logged in as administrator' status and a 'Logout' link.

Normalization for national and local calls is possible with special variables `${caller_cc}` and `${caller_ac}` that can be used in Replacement Pattern and are substituted by the country and area code accordingly during the call routing.



Important

These variables are only being filled in when a call originates from a subscriber (because only then the cc/ac information is known by the system), so you can not use them when a calls comes from a SIP peer (the variables will be just empty in this case).

Tip

When routing a call, the rewrite processing is stopped after the first match of a rule, starting from top to bottom. If you have two rules (e.g. a generic one and a more specific one), where both of them would match some numbers, reorder them with the up/down arrows into the appropriate position.

Rewrite Rules for domain-dialplan

← Back

★ Create Rewrite Rule

Rewrite rule successfully created

Inbound Rewrite Rules for Caller

	Match Pattern	Replacement Pattern	Description
1	↑ ↓ <input type="checkbox"/> <input type="checkbox"/>	^(00 \+)([1-9][0-9]+)\$	\2 International to E.164
	↑ ↓ <input type="checkbox"/> <input type="checkbox"/> 2	^0([1-9][0-9]+)\$	\$(caller_cc)\1 National to E.164
	↑ ↓ <input type="checkbox"/> <input type="checkbox"/>	^([1-9][0-9]+)\$	\$(caller_cc)\$(caller_ac)\1 Local to E.164

Inbound Rewrite Rules for Callee

Outbound Rewrite Rules for Caller

Outbound Rewrite Rules for Callee

6.7.2 Inbound Rewrite Rules for Callee

These rules are used to rewrite the number the end user dials to place a call to a standard format for routing lookup. In our example, we again allow the three different formats mentioned above and again normalize them to E.164, so we put in the same rules as for the caller.

STRIP LEADING 00 OR +

- Match Pattern: `^(00|\+)([1-9][0-9]+)$`
- Replacement Pattern: `\2`

- **Description:** International to E.164
- **Direction:** Inbound
- **Field:** Callee

REPLACE 0 BY CALLER'S COUNTRY CODE:

- **Match Pattern:** `^0([1-9][0-9]+)$`
- **Replacement Pattern:** `${caller_cc}\1`
- **Description:** National to E.164
- **Direction:** Inbound
- **Field:** Callee

NORMALIZE AREACODE-INTERNAL CALLS:

- **Match Pattern:** `^([1-9][0-9]+)$`
- **Replacement Pattern:** `${caller_cc}${caller_ac}\1`
- **Description:** Local to E.164
- **Direction:** Inbound
- **Field:** Callee

Tip

Our provided rules will only match if the caller dials a numeric number. If he dials an alphanumeric SIP URI, none of our rules will match and no rewriting will be done. You can however define rules for that as well. For example, you could allow your end users to dial `support` and rewrite that to your support hotline using the match pattern `^support$` and the replace pattern `43800999000` or whatever your support hotline number is.

6.7.3 Outbound Rewrite Rules for Caller

These rules are used to rewrite the calling party number for a call to an end user. For example, if you want the device of your end user to show `0<ac><sn>` if a national number calls this user, and `00<cc><ac><sn>` if an international number calls, put the following rules there.

REPLACE AUSTRIAN COUNTRY CODE 43 BY 0

- **Match Pattern:** `^43([1-9][0-9]+)$`
- **Replacement Pattern:** `0\1`
- **Description:** E.164 to Austria National

- **Direction:** Outbound
- **Field:** Caller

PREFIX 00 FOR INTERNATIONAL CALLER

- **Match Pattern:** `^ ([1-9] [0-9]+) $`
- **Replacement Pattern:** `00\1`
- **Description:** E.164 to International
- **Direction:** Outbound
- **Field:** Caller

Tip

Note that both of the rules would match a number starting with 43, so reorder the national rule to be above the international one (if it's not already the case).

6.7.4 Outbound Rewrite Rules for Callee

These rules are used to rewrite the called party number immediately before sending out the call on the network. This gives you an extra flexibility by controlling the way request appears on a wire, when your SBC or other device expects the called party number to have a particular tech-prefix. It can be used on calls to end users too if you want to do some processing in intermediate SIP device, e.g. apply legal intercept selectively to some subscribers.

PREFIX SIPSP# FOR ALL CALLS

- **Match Pattern:** `^ ([0-9]+) $`
- **Replacement Pattern:** `sipsp#\1`
- **Description:** Intercept this call
- **Direction:** Outbound
- **Field:** Callee

6.7.5 Emergency Number Handling

There are 2 ways to handle calls from local subscribers to emergency numbers in NGCP:

- *Simple* emergency number handling: inbound rewrite rules append an emergency tag to the called number, this will be recognised by NGCP's call routing logic and the call is routed directly to a peer. Please read the next section for details of simple emergency number handling.
- An emergency *number mapping* is applied: a dedicated emergency number mapping database is consulted in order to obtain the most appropriate routing number of emergency services. This logic ensures that the caller will contact the geographically closest emergency service. Please visit the [Emergency Mapping](#) section of the handbook for more details.

6.7.5.1 Simple Emergency Number Handling Overview

The overview of emergency call processing is as follows:

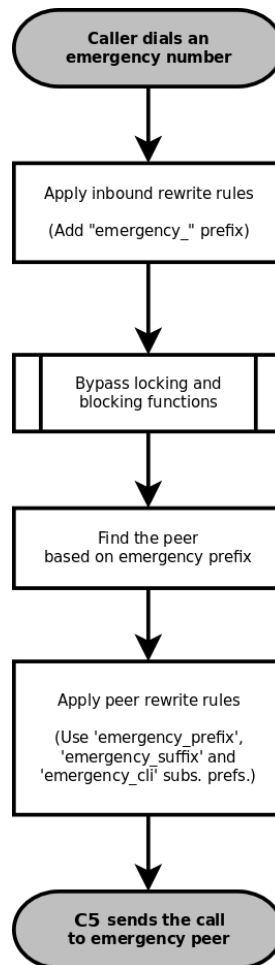

Figure 18: Simple Emergency Call Handling

Configuring Emergency Numbers is also done via Rewrite Rules.

6.7.5.2 Tagging Inbound Emergency Calls

For Emergency Calls from a subscriber to the platform, you need to define an *Inbound Rewrite Rule For Callee*, which adds a prefix `emergency_` to the number (and can rewrite the number completely as well at the same time). If the proxy detects a call to a SIP URI starting with `emergency_`, it will enter a special routing logic bypassing various checks which might make a normal call fail (e.g. due to locked or blocked numbers, insufficient credits or exceeding the max. amount of parallel calls).

TAG AN EMERGENCY CALL

- Match Pattern: `^(911|112)$`
- Replacement Pattern: `emergency_\1`

- **Description:** Tag Emergency Numbers
- **Direction:** Inbound
- **Field:** Callee

To route an Emergency Call to a Peer, you can select a specific peering group by adding a peering rule with a *callee prefix* set to *emergency_* to a peering group.

6.7.5.3 Normalize Emergency Calls for Peers

In order to normalize the emergency number to a valid format accepted by the peer, you need to assign an *Outbound Rewrite Rule For Callee*, which strips off the *emergency_* prefix. You can also use the variables `${caller_emergency_cli}`, `${caller_emergency_prefix}` and `${caller_emergency_suffix}` as well as `${caller_ac}` and `${caller_cc}`, which are all configurable per subscriber to rewrite the number into a valid format.

NORMALIZE EMERGENCY CALL FOR PEER

- **Match Pattern:** `^emergency_(.+)$`
- **Replacement Pattern:** `${caller_emergency_prefix}${caller_ac}\1`
- **Description:** Normalize Emergency Numbers
- **Direction:** Outbound
- **Field:** Callee

6.7.6 Assigning Rewrite Rule Sets to Domains and Subscribers

Once you have finished to define your Rewrite Rule Sets, you need to assign them. For sets to be used for subscribers, you can assign them to their corresponding domain, which then acts as default set for all subscribers. To do so, go to *Settings*→*Domains* and click *Preferences* on the domain you want the set to assign to. Click on *Edit* and select the Rewrite Rule Set created before.

← Back

Call Blockings

Access Restrictions 1

Number Manipulations

	Name	Value	
?	rewrite_rule_set 2	defaultdom	3 Edit
?	extension_in_npn	<input type="checkbox"/>	
?	inbound_upn	From-Username	
?	outbound_from_user	User-Provided-Number	

You can do the same in the *Preferences* of your subscribers to override the rule on a subscriber basis. That way, you can finely control down to an individual user the dial-plan to be used. Go to *Settings*→*Subscribers*, click the *Details* button on the subscriber you want to edit, then click the *Preferences* button.

6.7.7 Creating Dialplans for Peering Servers

For each peering server, you can use one of the Rewrite Rule Sets that was created previously as explained in Section 6.7 (keep in mind that special variables `${caller_ac}` and `${caller_cc}` can not be used when the call comes from a peer). To do so, click on the name of the peering server, look for the preference called *Rewrite Rule Sets*.

If your peering servers don't send numbers in E.164 format `<cc><ac><sn>`, you need to create *Inbound Rewrite Rules* for each peering server to normalize the numbers for caller and callee to this format, e.g. by stripping leading + or put them from national into E.164 format.

Likewise, if your peering servers don't accept this format, you need to create *Outbound Rewrite Rules* for each of them, for example to append a + to the numbers.

6.7.8 Call Routing Verification

The Sipwise C5 provides a utility that helps with the verification of call routing among local subscribers and peers. It is called *Call Routing Verification* and employs rewrite rules and peer selection rules, in order to process calling and called numbers or SIP users and find the appropriate peer for the destination.

The *Call Routing Verification* utility performs only basic number processing and does not invoke the full number manipulation logic applied on real calls. The goal is to enable testing of rewrite rules, rather than validate the complete number processing.

- What is considered during the test:
 - subscriber preferences: `cli` and `allowed_clis`
 - domain / subscriber / peer rewrite rules
- What is not taken into account during the test:
 - other subscriber or peer preferences
 - LNP (Local Number Portability) lookup on called numbers; LNP rewrite rules

You can access the utility following the path on Admin web interface: *Tools* → *Call Routing Verification*.

Expected input data

- `Caller number/uri`: 2 formats are accepted in this field:
 - A simple **phone number** in international (00431 . . , +431 . .) or E.164 (431 . .) format.
 - A SIP **URI** in `username@domain` format (without adding "sip:" at the beginning).
- `Callee number/uri`: The same applies as for `Caller number/uri`.
- `Caller Type`: Select `Subscriber` or `Peer`, depending on the source of the call.
- `Caller Subscriber` or `Caller Peer`: Optionally, you can select the subscriber or peer explicitly. Without the explicit selection, however, the *Call Routing Verification* tool is able to find the caller in the database, based on the provided number / URI.
- `Caller RWR Override`, `Callee RWR Override`, `Callee Peer Override`: The caller / callee rewrite rules and peer selection rules defined in domain, subscriber and peer preferences are used for call processing by default. But you can also override them by explicitly selecting another rewrite or peer selection rule.

Examples

1. Using only phone numbers and explicit subscriber selection

- Input Data:

Call Routing Verification

[← Back](#) [Expand Groups](#)

Caller number/url:

Callee number/url:

Caller Type: Subscriber Peer

Caller Subscriber Search:

#	Username	Domain	UUID	Number	
295	43993002	10.15.18.227	51e32173-c8a9-44f1-af30-a1ed431eb2bf		<input checked="" type="checkbox"/>
297	43993003	10.15.18.227	6feb9ea-21c0-4f55-8828-80d546b8998f		<input type="checkbox"/>
299	43993004	10.15.18.227	3543a26e-861b-459f-a348-a8ef3e1e9eab		<input type="checkbox"/>
301	43993005	10.15.18.227	355773d2-1c08-475c-8858-eaf75bb58c73		<input type="checkbox"/>

Showing 1 to 4 of 8 entries (filtered from 56 total entries) ← 1 2 →

Caller Rewrite Rules Override

Callee Rewrite Rules Override

Callee Peer Override

[Verify](#)

Figure 19: Call Routing Verif. - Only Numbers - Input

- Result:

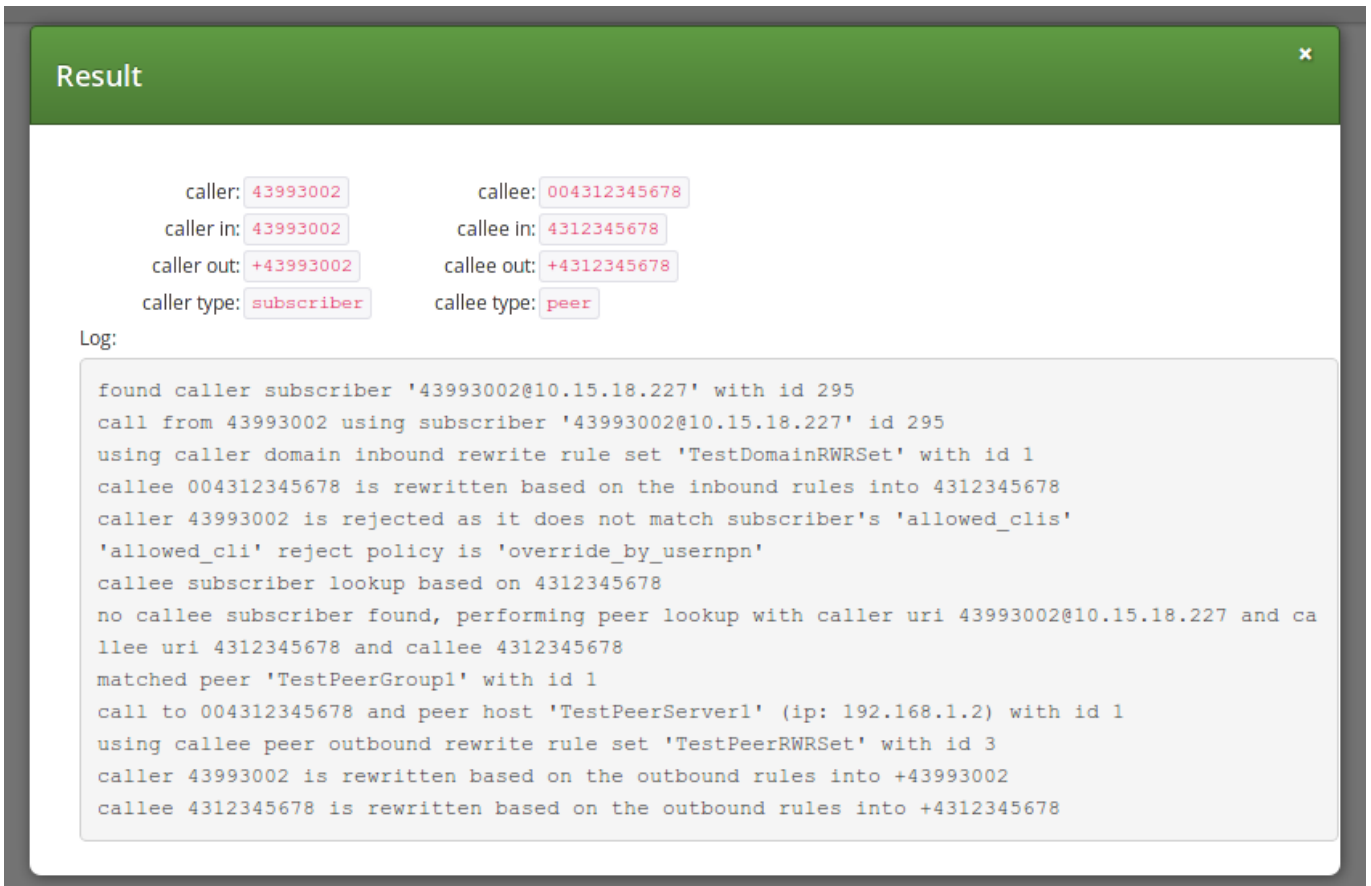

The screenshot shows a window titled "Result" with a green header and a close button. It displays call routing information for a call from 43993002 to 004312345678. The caller is identified as a subscriber, and the callee as a peer. A log section provides a detailed step-by-step account of the routing process, including domain rewrite rules, subscriber lookups, and peer group matching.

caller: 43993002 callee: 004312345678
caller in: 43993002 callee in: 4312345678
caller out: +43993002 callee out: +4312345678
caller type: subscriber callee type: peer

Log:

```
found caller subscriber '43993002@10.15.18.227' with id 295
call from 43993002 using subscriber '43993002@10.15.18.227' id 295
using caller domain inbound rewrite rule set 'TestDomainRWRSet' with id 1
callee 004312345678 is rewritten based on the inbound rules into 4312345678
caller 43993002 is rejected as it does not match subscriber's 'allowed_clis'
'allowed_cli' reject policy is 'override_by_usernpn'
callee subscriber lookup based on 4312345678
no callee subscriber found, performing peer lookup with caller uri 43993002@10.15.18.227 and ca
llee uri 4312345678 and callee 4312345678
matched peer 'TestPeerGroup1' with id 1
call to 004312345678 and peer host 'TestPeerServer1' (ip: 192.168.1.2) with id 1
using callee peer outbound rewrite rule set 'TestPeerRWRSet' with id 3
caller 43993002 is rewritten based on the outbound rules into +43993002
callee 4312345678 is rewritten based on the outbound rules into +4312345678
```

Figure 20: Call Routing Verif. - Only Numbers - Result

2. Using phone number and URI, without explicit subscriber selection

- Input Data:

Call Routing Verification

[← Back](#) [Expand Groups](#)

Caller number/uri

Callee number/uri

Caller Type Subscriber
 Peer

Caller Subscriber Search: .227

#	Username	Domain	UUID	Number	
295	43993002	10.15.18.227	51e32173-c8a9-44f1-af30-a1ed431eb2bf		<input type="checkbox"/>
297	43993003	10.15.18.227	6feb9ea-21c0-4f55-8828-80d546b8998f		<input type="checkbox"/>
299	43993004	10.15.18.227	3543a26e-861b-459f-a348-a8ef3e1e9eab		<input type="checkbox"/>
301	43993005	10.15.18.227	355773d2-1c08-475c-8858-eaf75bb58c73		<input type="checkbox"/>

Showing 1 to 4 of 8 entries (filtered from 56 total entries) ← 1 2 →

Caller Rewrite Rules Override

Callee Rewrite Rules Override

Callee Peer Override

[Verify](#)

Figure 21: Call Routing Verif. - Number and URI - Input

- Result:

Result

caller:	43993003	callee:	+431555666
caller in:	43993003	callee in:	431555666
caller out:	+43993003	callee out:	+431555666
caller type:	subscriber	callee type:	peer

Log:

```
no caller subscriber/peer was specified, using subscriber lookup based on caller 43993003@10.15.18.227
found caller subscriber '43993003@10.15.18.227' with id 297
call from 43993003 using subscriber '43993003@10.15.18.227' id 297
using caller domain inbound rewrite rule set 'TestDomainRWRSet' with id 1
callee +431555666 is rewritten based on the inbound rules into 431555666
caller 43993003 is rejected as it does not match subscriber's 'allowed_clis'
'allowed_cli' reject policy is 'override_by_usernpn'
callee subscriber lookup based on 431555666
no callee subscriber found, performing peer lookup with caller uri 43993003@10.15.18.227 and callee uri 431555666 and callee 431555666
matched peer 'TestPeerGroup1' with id 1
call to +431555666 and peer host 'TestPeerServer1' (ip: 192.168.1.2) with id 1
using callee peer outbound rewrite rule set 'TestPeerRWRSet' with id 3
caller 43993003 is rewritten based on the outbound rules into +43993003
callee 431555666 is rewritten based on the outbound rules into +431555666
```

Figure 22: Call Routing Verif. - Number and URI - Result

7 Features

The Sipwise C5 provides plenty of subscriber features to offer compelling VoIP services to end customers, and also to cover as many deployment scenarios as possible. In this chapter, we provide the features overview and describe their function and use cases.

7.1 About the Admin Web Interface

This section is going to give some hints to the reader about the Admin web interface of Sipwise C5. The notes here are generic and apply to most of the features that we discuss in the handbook in subsequent chapters.

7.1.1 Filtering the Lists / Databases

When you look at or want to change various settings on Admin web interface you will see datatables or lists of particular items, e.g. Subscribers, Peering Groups, etc. Sometimes this kind of list can be really long and then it's difficult to find the desired item there. To help the system administrator, the Sipwise C5 offers search filters for each of the lists / databases. You have to simply type a search string (arbitrary text) in the *Search* textbox and the system will automatically filter the complete datatable for records that match the search string.

The screenshot shows the 'Subscribers' page with a search filter applied. The search string '200' is entered in the search box. The results table shows 5 entries, all with the status 'active'. The search string '200' is circled in red, and the search box is highlighted with a blue border. The status 'active' is also circled in red for the first entry.

#	Contract #	Contact Email	Username	Domain	UUID	Status	Number	Profile
39	3	tv@enterprise.org	ext200	1.c5.com	f25dc6e-c56e-431a-9e7a-eada925f0de7	active	40333100200	
105	21	machsols4b_customer@example.org	machsols4b_subs2	afa78b9d-c02b-41de-9a77-d82006698e7a	active	438882200102	
121	27	basicsip@boghici.au	555200	c5.com	42e03f31-c068-46d8-9a58-0f2f9d938749	active	39555200	
159	19	cbs@tt.org	ext200	c5.com	86195f25-ab71-4aaa-85a8-caefb33b3fc0	active	44266200	
35	21	machsols4b_customer@example.org	machsols4b_subs101	s4b.c5.com	377394fe-2f67-4feb-8013-3fc35544807a	active	438881200101	

Showing 1 to 5 of 5 entries (filtered from 49 total entries)

Figure 23: Filtered List of Subscribers

The Search String

The previous example shows what happens if you type a search string in the *Search* textbox. The search string will be applied to all visible columns of the datatable as a filter and all matching records are kept displayed.

The * symbol can be used as **wildcard** for zero-or-more characters.

Note

The * is prepended and appended implicitly to the string entered in *Search* textbox to make filtering easier, for almost all datatables / lists.

While the search pattern is typically matched to values of all columns visible in the datatable, in some cases (i.e. unindexed columns) may be excluded from searching.

7.1.2 Call History

Each call appears in the subscriber's *Call History*, except globally suppressed ones (if suppressing is configured), and you can apply search filters to the table as in case of other datatables.

The *Call History* datatable behaves slightly differently when it comes to wildcard usage. The * wildcard needs to be entered explicitly by the user if needed.

Call List for machsols4b_subs2@ [redacted] (43 888 2200102)

[← Back](#)

Show all calls From Date: To Date: Search:

Show 10 entries

#	Caller	Callee	CLIR	Billing zone	Status	Start Time	Duration	MOS avg	MOS packetloss	MOS jitter	MOS roundtrip	Call-ID	Cost
1505	438882200102	s4b_int432158@ [redacted]	0		cancel	2018-08-06 11:27:41.945	0:00:00					d54aec4a71e57db7c38db9e8c8f894e1d	0.00
1507	438882200102	s4b_int31882200101@ [redacted]	0		noanswer	2018-08-06 11:28:10.273	0:00:00					d2f5a87577ee338fb326743fb2894e1d	0.00
1509	438882200102	s4b_int31882200101@ [redacted]	0	all	ok	2018-08-06 11:29:54.920	0:00:21.891	4.3	0.0	0.0	9999.0	13148ad1d3c16da8eba7dd5443894e1d	0.00
Total							0:00:21.891						0.00

Showing 1 to 3 of 3 entries (filtered from 10 total entries)

← ← 1 → →

Figure 24: Filtered Call History



Caution

Be aware that acceptable response times of the administrative web interface rely on utilizing available database indexes, which is impossible with a leading wildcard in the search string. Wildcards at the end of the search pattern do not impact performance.

7.2 Managing System Administrators

The Sipwise C5 offers the platform operator with an easy to use interface to manage users with administrative privileges. Such users are representatives of resellers, and are entitled to manage configuration of services for *Customers*, *Subscribers*, *Domains*, *Billing Profiles* and other entities on Sipwise C5.

Administrators, as user accounts, are also used for client authentication on the REST API of NGCP.

There is a single administrator (username: "administrator"), whose account is enabled by default and who belongs to the *default reseller*. This user is the *superuser* of Sipwise C5 administrative web interface (the so-called "admin panel"), and he has the right to modify administrators of other *Resellers* as well.

7.2.1 Configuring Administrators

Configuration of access rights of system administrators is possible through the admin panel of NGCP. In order to do that, please navigate to *Settings* → *Administrators*.

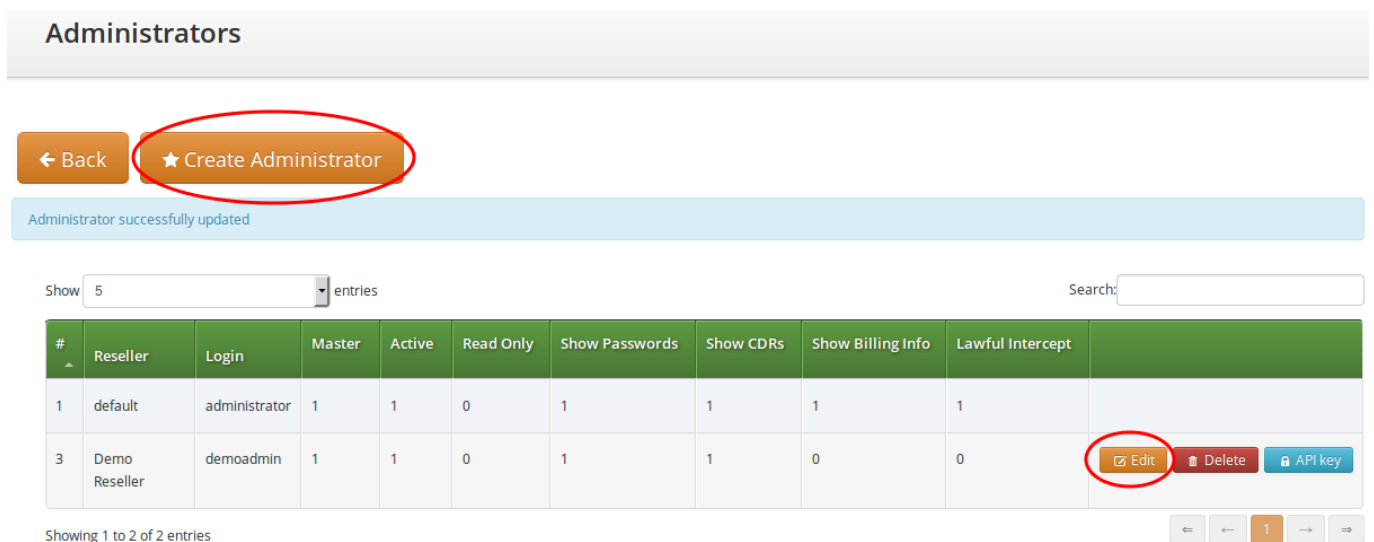

Administrators

← Back ★ Create Administrator

Administrator successfully updated

Show 5 entries Search:

#	Reseller	Login	Master	Active	Read Only	Show Passwords	Show CDRs	Show Billing Info	Lawful Intercept	
1	default	administrator	1	1	0	1	1	1	1	
3	Demo Reseller	demoadmin	1	1	0	1	1	0	0	Edit Delete API key

Showing 1 to 2 of 2 entries

Figure 25: List of System Administrators

You have 2 options:

- If you'd like to **create** a new administrator user press *Create Administrator* button.
- If you'd like to **update** an existing administrator user press *Edit* button in its row.

There are some generic attributes that have to be set for each administrator:

✕

Edit Administrator

Reseller Search:

#	Name	Contract #	Status	
16	Demo Reseller	200	active	<input checked="" type="checkbox"/>
1	default	1	active	<input type="checkbox"/>
		137	active	<input type="checkbox"/>

Showing 1 to 3 of 3 entries

← ← 1 → →

Create Reseller

Login

Password

Is superuser

Save

Figure 26: Generic System Administrator Attributes

- *Reseller*: each administrator user must belong to a *Reseller*. There is always a default reseller (ID: 1, Name: default), but the administrator has to be assigned to his real reseller, if such an entity (other than default) exists.
- *Login*: the login name of the administrator user
- *Password*: the password of the administrator user for logging in the admin panel, or for authentication on REST API

The second set of attributes is a list of access rights that are discussed in subsequent section of the handbook.

7.2.2 Access Rights of Administrators

The various access rights of administrators are shown in the figure and summarized in the table below.

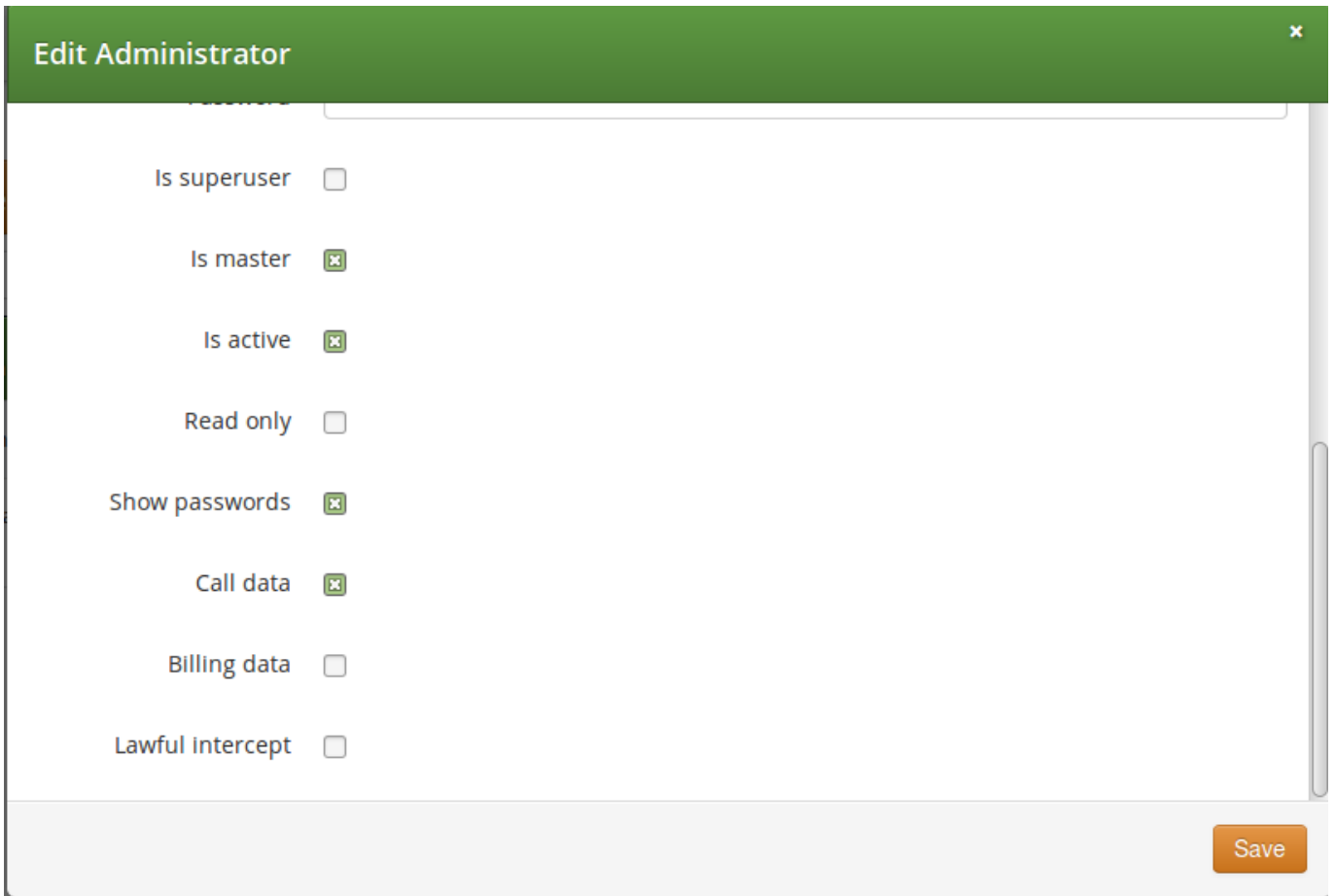

Figure 27: Access Rights of System Administrators

Table 2: Access Rights of System Administrators

Label in admin list	Access Right	Description
<i>not shown</i>	Is superuser	The user is allowed to modify data on Reseller level and — among others — is able to modify administrators of other resellers. There should be only 1 user on Sipwise C5 with this privilege.
Master	Is master	The user is allowed to create, delete or modify other Admins who belong to the same Reseller.
Active	Is active	The user account is active, i.e. the admin user can login on the web panel or authenticate himself on REST API; otherwise user authentication will fail.

Table 2: (continued)

Label in admin list	Access Right	Description
Read Only	Read only	<p>The user will only be able to list various data but is not allowed to modify anything.</p> <ul style="list-style-type: none"> For the web interface this means that <i>Create...</i> and <i>Edit</i> buttons will be hidden or disabled. For the REST API this means that only <code>GET</code>, <code>HEAD</code>, <code>OPTIONS</code> HTTP request methods are accepted, and Sipwise C5 will reject those targeting data modification: <code>PUT</code>, <code>PATCH</code>, <code>POST</code>, <code>DELETE</code>.
Show Passwords	Show passwords	<p>The user sees subscriber passwords (in plain text) on the web interface.</p> <hr/> <p>Note</p> <p>Admin panel user passwords are stored in an unreadable way (cryptographic hash digest) in the database, while subscriber passwords are basically always stored in plain text. The latter happens on purpose, e.g. to make subscriber data migration possible.</p> <hr/>
Show CDRs	Call data	<p>This privilege has effect on 2 items that will be displayed on admin panel of NGCP, when <i>Subscriber</i> → <i>Details</i> is selected:</p> <ol style="list-style-type: none"> PBX Groups list Captured Dialogs list
Show Billing Info	Billing data	<p>Some REST API resources that are related to billing are disabled: HTTP requests on <code>/api/vouchers</code>, <code>/api/topupcash</code> and <code>/api/topupvoucher</code> resources are rejected.</p>
Lawful Intercept	Lawful intercept	<p>If the privilege is selected then the REST API for interceptions (that is: <code>/api/interceptions</code>) is enabled; if the privilege is not selected then the interceptions API is disabled.</p> <hr/> <p>Note</p> <p>This means that besides enabling LI in <code>config.yml</code> configuration file one also needs to enable the API via the LI privilege of an administrator user, so that Sipwise C5 can really provide LI service.</p> <hr/>

7.3 Access Control for SIP Calls

There are two different methods to provide fine-grained call admission control to both subscribers and admins. One is *Block Lists*, where you can define which numbers or patterns can be called from a subscriber to the outbound direction and which numbers or patterns are allowed to call a subscriber in the inbound direction. The other is *NCOS (Network Class of Service) Levels*, where the admin predefines rules for outbound calls, which are grouped in certain levels. The subscriber can then just choose the level, or the admin can restrict a subscriber to a certain level. Also Sipwise C5 offers some options to restrict the IP addresses that subscriber is allowed to use the service from. The following sections describe these features in detail.

7.3.1 Block Lists

Block Lists provide a way to control which users/numbers can call or be called, based on a subscriber level, and can be found in the *Call Blockings* section of the subscriber preferences.

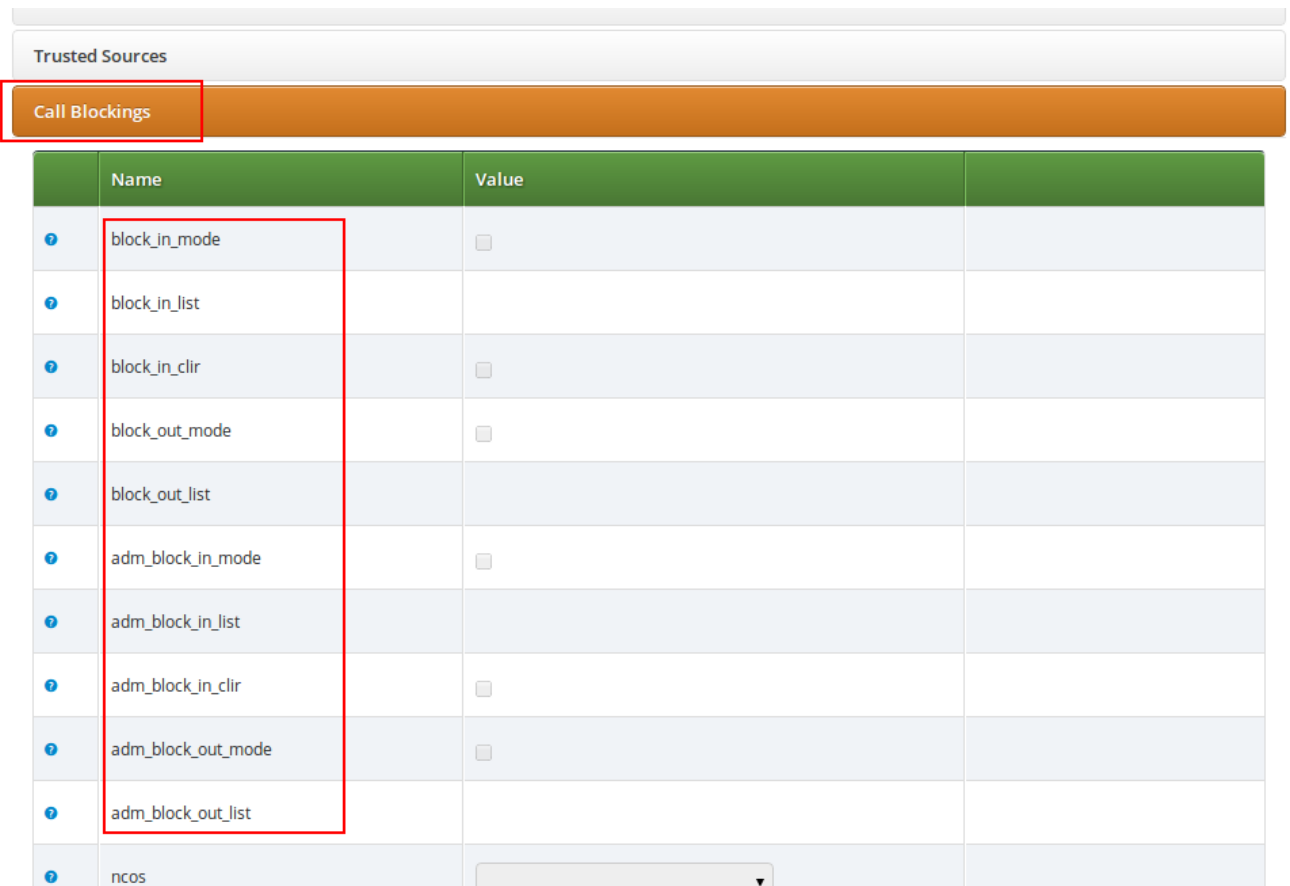

	Name	Value
?	block_in_mode	<input type="checkbox"/>
?	block_in_list	
?	block_in_clir	<input type="checkbox"/>
?	block_out_mode	<input type="checkbox"/>
?	block_out_list	
?	adm_block_in_mode	<input type="checkbox"/>
?	adm_block_in_list	
?	adm_block_in_clir	<input type="checkbox"/>
?	adm_block_out_mode	<input type="checkbox"/>
?	adm_block_out_list	
?	ncos	<input type="text" value=""/>

Block Lists are separated into *Administrative Block Lists (adm_block_*)* and *Subscriber Block Lists (block_*)*. They both have the same behaviour, but Administrative Block Lists take higher precedence. Administrative Block Lists are only accessible by the system administrator and can thus be used to override any Subscriber Block Lists, e.g. to block certain destinations. The following break-down of the various block features apply to both types of lists.

7.3.1.1 Block Modes

Block lists can either be *whitelists* or *blacklists* and are controlled by the User Preferences *block_in_mode*, *block_out_mode* and their administrative counterparts.

- The *blacklist* mode (option is not checked) tells the system to **allow anything except the entries in the list**. Use this mode if you just want to block certain numbers and allow all the rest.
- The *whitelist* mode indicates to **reject anything except the entries in the list**. Use this mode if you want to enforce a strict policy and allow only selected destinations or sources.

You can change a list mode from one to the other at any time.

7.3.1.2 Block Lists

The list contents are controlled by the User Preferences *block_in_list*, *block_out_list* and their administrative counterparts. Click on the *Edit* button in the *Preferences* view to define the list entries.

In block list entries, you can provide shell patterns like `*` and `[]`. The behavior of the list is controlled by the *block_xxx_mode* feature (so they are either allowed or rejected). In our example above we have *block_out_mode* set to *blacklist*, so all calls to US numbers and to the Austrian number +431234567 are going to be rejected.

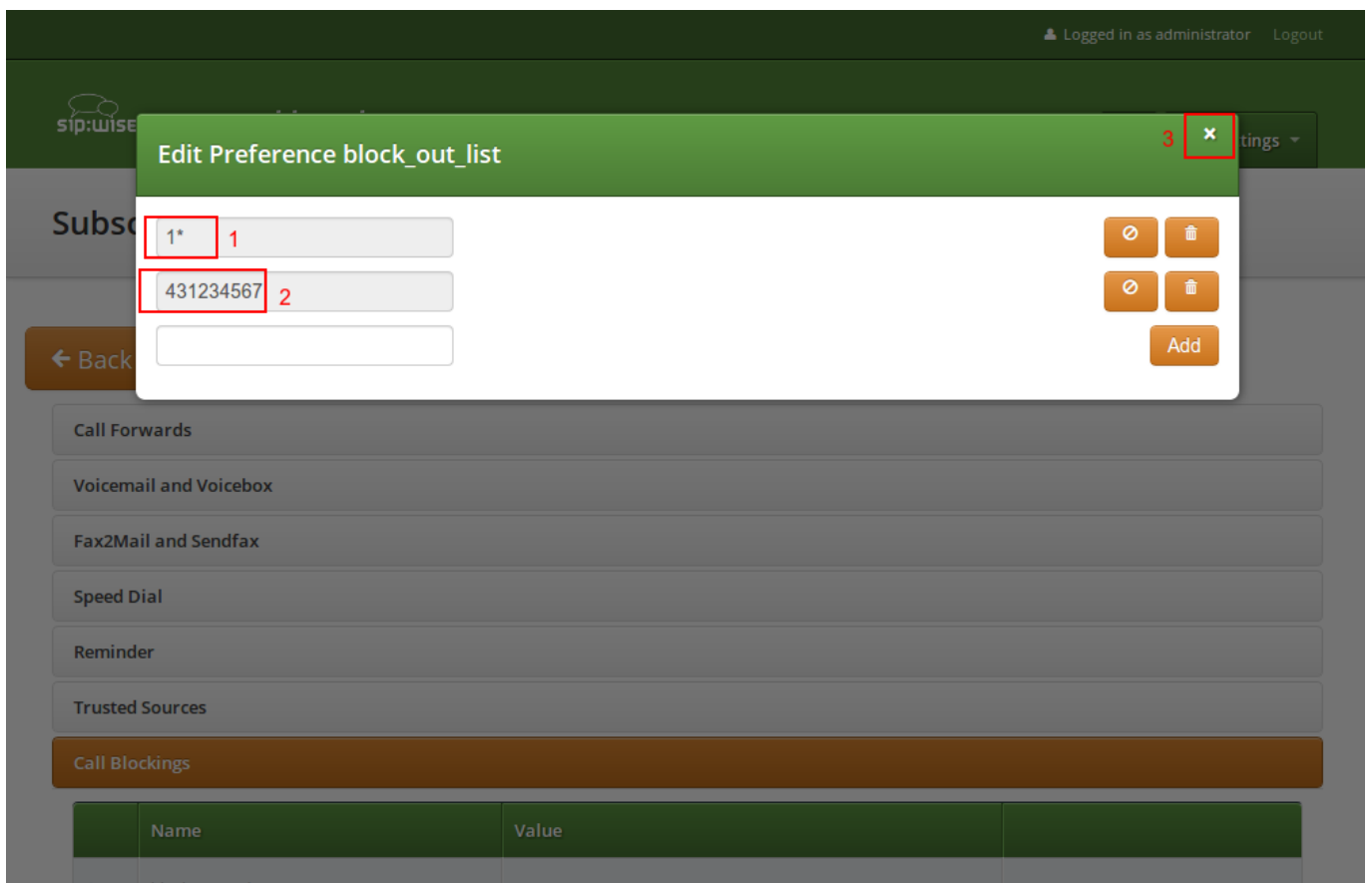

Click the *Close* icon once you're done editing your list.

7.3.1.3 Block Anonymous Numbers

For incoming call, the User Preference *block_in_clir* and *adm_block_in_clir* controls whether or not to reject incoming calls with number suppression (either "[Aa]nonymous" in the display- or user-part of the From-URI or a header *Privacy: id* is set). This flag is independent from the Block Mode.

7.3.2 NCOS (Network Class of Service) Levels

NCOS Levels provide predefined lists of allowed or denied destinations for outbound calls of local subscribers. Compared to *Block Lists*, they are much easier to manage, because they are defined on a global scope, and the individual levels can then be assigned to each subscriber. Again there is the distinction for the user- and administrative- levels.

In a case of a conflict, when the Block Lists feature allows a number and NCOS Levels rejects the same number or vice versa, the call will be rejected.

NCOS levels can either be *whitelists* or *blacklists*.

- The *blacklist* mode indicates to **allow everything except the entries in this level**. Use this mode if you want to block specific destinations and allow all the rest.
- The *whitelist* mode indicates to **reject anything except the entries in this level**. Use this mode if you want to enforce a strict policy and allow only selected destinations.

7.3.2.1 Creating NCOS Levels

To create an NCOS Level, go to *Settings*→*NCOS Levels* and press the *Create NCOS Level* button.

The screenshot shows the Sipwise NGCP Dashboard interface. At the top right, it indicates the user is logged in as 'administrator' with a 'Logout' link. The dashboard title is 'sip:wise NGCP Dashboard'. Below the title bar, there are navigation buttons for 'Home' and 'Settings'. The main section is titled 'NCOS Levels'. Below this title, there are two buttons: 'Back' and 'Create NCOS Level'. The 'Create NCOS Level' button is highlighted with a red rectangular box. To the right of these buttons is a search input field labeled 'Search:'. Below the search field is a table with the following columns: '#', 'Reseller', 'Level Name', 'Mode', and 'Description'. The table is currently empty, displaying the message 'No data available in table'. Below the table, it says 'Showing 0 to 0 of 0 entries' and there are four small navigation icons (back, forward, etc.). At the bottom of the dashboard, there is a footer with the text '© 2013 Sipwise GmbH, all rights reserved.'

Select a reseller, enter a name, select the mode and add a description, then click the *Save* button.

Reseller

Search:

#	Name	Contract #	Status	
1	default	1	active	1 <input checked="" type="checkbox"/>

Showing 1 to 1 of 1 entries

Create Reseller

Level Name 2

Mode 3

Description 4

5

© 2013 Sipwise GmbH, all rights reserved.

7.3.2.2 Creating Rules per NCOS Level

To define the rules within the newly created NCOS Level, click on the *Patterns* button of the level.

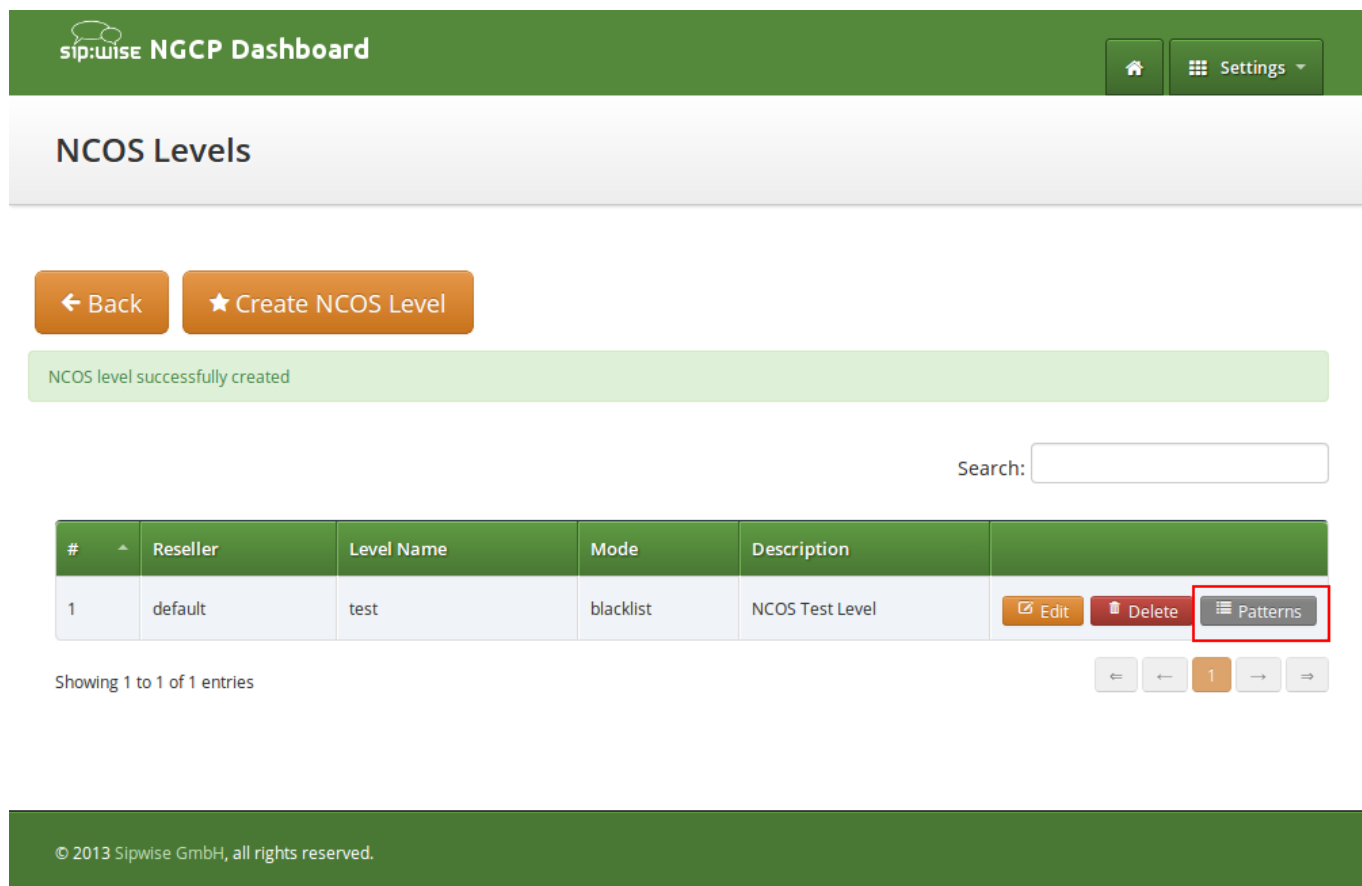

← Back ★ Create NCOS Level

NCOS level successfully created

Search:

#	Reseller	Level Name	Mode	Description	
1	default	test	blacklist	NCOS Test Level	Edit Delete Patterns

Showing 1 to 1 of 1 entries

© 2013 Sipwise GmbH, all rights reserved.

There are 2 groups of patterns where you can define matching rules for the selected NCOS Level:

- **NCOS Number Patterns:** here you can define number patterns that will be matched against the called number and allowed or blocked, depending on whitelist / blacklist mode. The patterns are regular expressions.
- **NCOS LNP Carriers:** here you can select predefined *LNP Carriers* that will be allowed (whitelist mode) or prohibited (blacklist mode) to route calls to them. For each of them you can restrict the matching to a predefined number pattern. (See Section 7.5.1 in the handbook for the description of LNP functionality)

Note

Sipwise C5 performs number matching always with the dialed number and not with the number generated after LNP lookup that is: either the original dialed number prefixed with an LNP carrier code, or the routing number.

NCOS Number Patterns

← Back ★ Create Pattern Entry

NCOS pattern successfully created

Show 5 entries Search:

#	Pattern	Description
1	^439	Austrian Premium Numbers

Showing 1 to 1 of 1 entries

Include local area code
 Intra PBX Calls within same customer

✎ Edit

NCOS LNP Carriers

★ Create LNP Entry

Show 5 entries Search:

#	LNP Carrier	Description
1	LNP_Carr1	Rule for LNP Carrier 1

Showing 1 to 1 of 1 entries

Figure 28: NCOS Patterns List

In the **NCOS Number Patterns** view you can create multiple patterns to define your level, one after the other. Click on the *Create Pattern Entry* Button on top and fill out the form.

Create Number Pattern ×

Pattern: ^439

Description: Austrian Premium Numbers

Save

Figure 29: Create NCOS Number Pattern

In this example, we block (since the mode of the level is *blacklist*) all numbers starting with 439. Click the *Save* button to save the entry in the level.

There are **2 options** that help you to easily define specific number ranges that will be allowed or blocked, depending on whitelist / blacklist mode:

- *Include local area code*: all subscribers within the caller's local area, e.g. if a subscriber has country-code 43 and area-code 1, then selecting this checkbox would result in the implicit number pattern: 431 .
- *Intra PBX calls within same customer*: all subscribers that belong to the same PBX customer as the caller himself.

In the **NCOS LNP Carriers** view you can select specific LNP Carriers—i.e. carriers that host the called ported numbers—that will be allowed or blocked for routing calls to them (whitelist / blacklist mode, respectively).

An example of *NCOS LNP Carrier* definition:

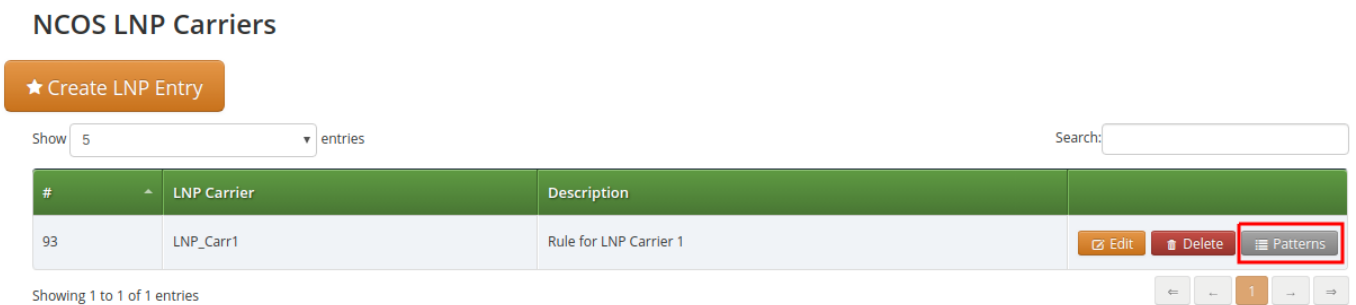

Figure 30: Create NCOS LNP Carrier

In the above example we created a rule that blocks calls to "LNP_Carr1" carrier, supposing we use blacklist mode of the NCOS Level.

In the **LNP NCOS Number Patterns** view you can create multiple patterns to restrict *NCOS LNP Carrier* matching, one after the other. Click on the *Create LNP Pattern Entry* Button on top and fill out the form.

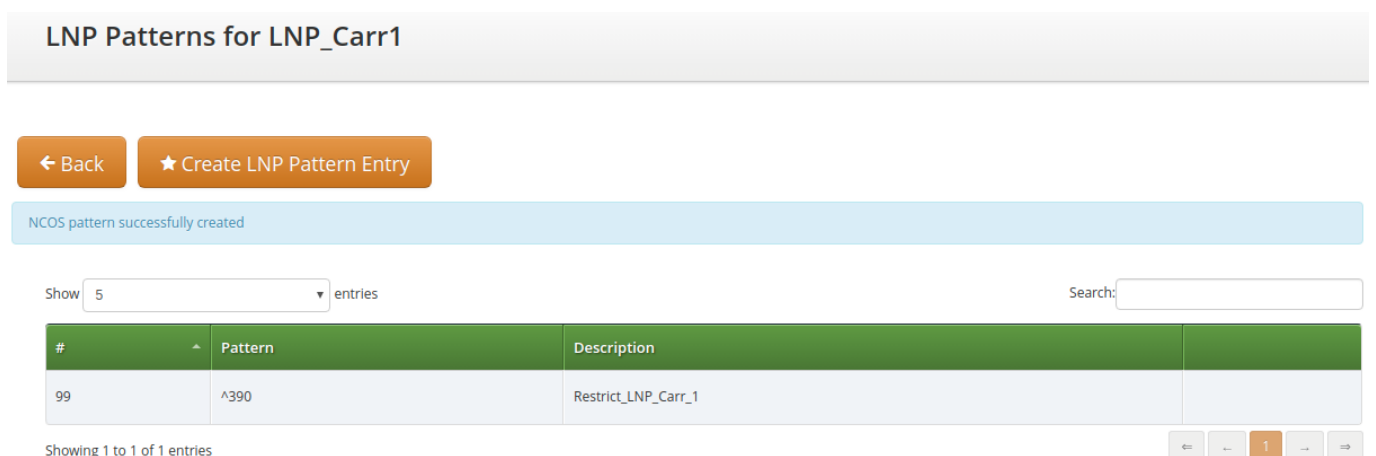

Figure 31: Create NCOS LNP Carrier Pattern

Considering the example before and adding the pattern shown in the picture, the rule now blocks only calls to "LNP_Carr1" carrier

that starts with 390.

Tip

There might be situations when phone number patterns may not be strictly aligned with telephony providers, for instance in case of full number portability in a country. In such cases using *NCOS LNP Carriers* patterns still allows for defining NCOS levels that allow / block calls to mobile numbers, for example. In order to achieve this goal you have to list all LNP carriers in the NCOS patterns that are known to host mobile numbers.

The below table gives an overview of all the possible combinations of *NCOS* and *NCOS LNP Carrier*:

Table 3: NCOS combinations

TYPE	NCOS	NCOS_LNP	RESULT
Whitelist	empty table	empty table	Blocked
Whitelist	empty table	no match	Blocked
Whitelist	empty table	match	Allowed
Whitelist	no match	empty table	Blocked
Whitelist	no match	no match	Blocked
Whitelist	no match	match	Blocked*
Whitelist	match	empty table	Allowed
Whitelist	match	no match	Blocked*
Whitelist	match	match	Allowed
Blacklist	empty table	empty table	Allowed
Blacklist	empty table	no match	Allowed
Blacklist	empty table	match	Blocked
Blacklist	no match	empty table	Allowed
Blacklist	no match	no match	Allowed
Blacklist	no match	match	Blocked
Blacklist	match	empty table	Blocked
Blacklist	match	no match	Blocked
Blacklist	match	match	Blocked

- = different behaviour compared with the previous versions (< mr7.5)

The parameter `kamailio.proxy.lnp.strictly_check_ncos` contained in `/etc/ngcp-config/config.yml` specify whether the NCOS LNP should be evaluated even if the LNP lookup was not previously executed (because not required by the inbound/outbound call) or if it didn't return any occurrence. If set to `yes`, a whitelist NCOS will fail if the LNP lookup doesn't return any match. The parameter has no impact on blacklist NCOS.

7.3.2.3 Assigning NCOS Levels to Subscribers/Domains

Once you've defined your NCOS Levels, you can assign them to local subscribers. To do so, navigate to *Settings*→*Subscribers*, search for the subscriber you want to edit, press the *Details* button and go to the *Preferences* View. There, press the *Edit* button on either the *ncos* or *adm_ncos* setting in the *Call Blockings* section.

Call Blockings	
Name	Value
block_in_mode	<input type="checkbox"/>
block_in_list	
block_in_clir	<input type="checkbox"/>
block_out_mode	<input type="checkbox"/>
block_out_list	1* 431234567
adm_block_in_mode	<input type="checkbox"/>
adm_block_in_list	
adm_block_in_clir	<input type="checkbox"/>
adm_block_out_mode	<input type="checkbox"/>
adm_block_out_list	
ncos	<input type="text" value="ncos"/> <input type="button" value="Edit"/>

You can assign the NCOS level to all subscribers within a particular domain. To do so, navigate to *Settings*→*Domains*, select the domain you want to edit and click *Preferences*. There, press the *Edit* button on either *ncos* or *admin_ncos* in the *Call Blockings* section.

Note: if both domain and subscriber have same NCOS preference set (either *ncos* or *adm_ncos*, or both) the subscriber's preference is used. This is done so that you can override the domain-global setting on the subscriber level.

7.3.2.4 Assigning NCOS Level for Forwarded Calls to Subscribers/Domains

In some countries there are regulatory requirements that prohibit subscribers from forwarding their numbers to special numbers like emergency, police etc. While Sipwise C5 does not deny provisioning Call Forward to these numbers, the administrator can prevent the incoming calls from being actually forwarded to numbers defined in the NCOS list: just select the appropriate NCOS level in the domain's or subscriber's preference *adm_cf_ncos*. This NCOS will apply only to the Call Forward from the subscribers and not to the normal outgoing calls from them.

7.3.3 IP Address Restriction

The Sipwise C5 provides subscriber and domain preference *allowed_ips* to restrict the IP addresses that a particular subscriber or any subscribers within the respective domain is allowed to use the service from. If the REGISTER or INVITE request comes from an IP address that is not in the allowed list, Sipwise C5 will reject it with a 403 message. Also a voice message can be played when the call attempt is rejected (if configured).

By default, *allowed_ips* is an empty list which means that subscriber is not restricted. If you want to configure a restriction, navigate to *Settings*→*Subscribers*→*Preferences* or *Settings*→*Domains*→*Preferences*, and search for the *allowed_ips* preference in the *Access Restrictions* section.

Call Blockings			
Access Restrictions			
1	Name	Value	
?	lock		
?	concurrent_max		
?	concurrent_max_out		
?	allowed_clis		
?	reject_emergency	<input type="checkbox"/>	
?	concurrent_max_per_account		
?	concurrent_max_out_per_account		
?	allowed_ips 2		3 <input type="button" value="Edit"/>
?	man_allowed_ips		
?	ignore_allowed_ips	<input type="checkbox"/>	
?	allow_out_foreign_domain	<input type="checkbox"/>	

Press the Edit button to the right of empty drop-down list.

You can enter multiple allowed IP addresses or IP address ranges one after another. Click the *Add* button to save each entry in the list. Click the *Delete* button if you want to remove some entry.

7.3.4 CLI-based Access Control

The Sipwise C5 provides subscriber preference *upn_block_list* to restrict the CLI that subscriber is allowed to use the service from. If the INVITE request comes with a CLI that is not in the allowed list, Sipwise C5 will reject it with a 403 message. Also a voice message can be played when the call attempt is rejected (if configured).

The restriction is applied to User-Provided Number (UPN) which is obtained from the configurable source based on the setting of

inbound_upn preference in the *Access Restrictions* section in the Domain and/or User preferences, after it has been rewritten with Inbound Rewrite Rules for Caller.

In case the *inbound_upn* preference is set to the "From Display-Name" the UPN value can be alpha-numeric so the access control supports the alpha-numeric (caller name) matching as well. If the incoming message does not have the Display-Name, though, the UPN value will be taken from the From-Username.

By default, *upn_block_list* is an empty list which means that subscriber is not restricted. If you want to configure a restriction, navigate to *Settings*→*Subscribers*, search for the subscriber you want to edit, press *Details* and then *Preferences* and press *Edit* for the *upn_block_list* preference in the *Call Blockings* section to define the list entries.

In block list entries, you can provide shell patterns like * and []. The CLI-based block list can either be *whitelist* or *blacklist*.

- The *blacklist* mode indicates to **allow everything except the entries in this list**. This is the default mode of operation and is effective when the preference *upn_block_mode* is unset.
- The *whitelist* mode indicates to **reject anything except the entries in this list**. In order to switch to this mode, set the preference *upn_block_mode* (it is a toggle between whitelist/blacklist).

If separate preference *upn_block_clir* is enabled, incoming anonymous calls from this user will be dropped.

If the caller's UPN is allowed it is also checked according to *allowed_clis* preference as usual and can be rewritten according to *allowed_clis_reject_policy* for correct calling number presentation on outgoing calls. This step happens after Access Control.

7.4 Call Forwarding and Call Hunting

The Sipwise C5 provides the capabilities for normal *call forwarding* (deflecting a call for a local subscriber to another party immediately or based on events like the called party being busy or doesn't answer the phone for a certain number of seconds) and *serial call hunting* (sequentially executing a group of deflection targets until one of them succeeds). Targets can be stacked, which means if a target is also a local subscriber, it can have another call forward or hunt group which is executed accordingly.

7.4.1 Call Forward Types

Currently 6 different types of Call Forward are available in Sipwise C5:

- **Call Forward Unconditional (CFU)**: The call forward is always executed, completely disregarding the subscriber state.
- **Call Forward Busy (CFB)**: The call forward is executed when the subscriber returns a busy state.
- **Call Forward Timeout (CFT)**: The call forward is executed when no answer is received from the subscriber before the timeout expiration. Timeout is configurable in *ringtimeout* subscriber preference.
- **Call Forward Unavailable (CFNA)**: The call forward is executed when the subscriber has no endpoint registered.
- **Call Forward SMS (CFS)**: The SMS forward is always executed, completely disregarding the subscriber state. SMS service has to be enabled, see the [SMS \(Short Message Service\)](#) subchapter for a detailed description on how to activate it.

- **Call Forward Rerouting (CFR):** The call forward is executed only for particular reply codes received back from the destination endpoint. The list of the reply codes and the activation mode can be configured in *rerouting_codes* and *rerouting_mode* subscriber's preferences. Example: suppose that *rerouting_codes* is set to 503, *rerouting_mode* to whitelist and the CFR is configured. If that subscriber receives a call and it replies back with code 503, then the call will be re-routed to the destination configured in the CFR. For all the other reply codes the CFR will be NOT executed.



Important

Starting from mr7.2.1 release, **Call Forward Rerouting (CFR)** has to be configured on the **callee** subscriber (in previous versions the preference associated to the caller subscriber). When the destination endpoint replies back with an error code, this will be matched with the one listed in the *rerouting_codes* and *rerouting_mode* callee's preferences.

7.4.2 Setting a simple Call Forward

Go to your *Subscriber Preferences* and click *Edit* on the Call Forward Type you want to set (e.g. *Call Forward Unconditional*).

If you select *URI/Number* in the *Destination* field, you also have to set a *URI/Number*. The timeout defines for how long this destination should be tried to ring.

7.4.3 Call Forward Destinations

- **Voicemail:** Calls are forwarded to the Voicemail Application Server where the caller can leave a message.
- **Conference:** Calls are forwarded to the conference room. The subscriber is the host of the conference.
- **Fax2Mail:** Calls are forwarded to the Fax Server and the caller is supposed to leave a fax message. Note: The Fax2Mail feature must be enabled in the subscriber's preferences.

- **Custom Announcement:** A custom announcement is played back to the caller. Select an announcement from the *Custom announcement* list.
- **Manager Secretary:** Calls are forwarded to numbers defined in the "manager_secretary_numbers" subscriber preference. The "manger_secretary" feature must be enabled.
- **URI/Number:** The call is forwarded to the provided SIP-URI string or a number (See the *Call Forward Destination Extra Parameters* section below).

7.4.3.1 Call Forward Destination Options

- **URI/Number:** A destination to forward calls to. This option is only valid for the *URI/Number* destination type. Specify a valid SIP-URI string or a plain number.
- **for (seconds):** Sets the ringing time, after which the call is forwarded to the next number on the list (if configured).
- **Custom Announcement:** Custom Announcements are created in Sound Sets and must have the name like *custom_announcement_0*, where the trailing symbol is a digit from 0 to 9.

7.4.4 Advanced Call Hunting

Beside call forwarding to a single destination, Sipwise C5 offers the possibility to activate call forwarding in a more sophisticated way:

- to multiple destinations (→ *Destination Set*)
- only during a pre-defined time set (→ *Time Set*)
- only for specific callers (→ *Source Set*)
- only for specific callee (→ *B-Number Set*)

If you want to define such more detailed call forwarding rules, you need to change into the *Advanced View* when editing your call forward. There, you can select multiple *Destination Set - Time Set - Source Set - B-Number Set* groups that determine all conditions under which the call will be forwarded.

Explanation of call forward parameters

- A **Destination Set** is a list of destinations where the call will be routed to, one after another, according to the order of their assigned priorities. See the [Destination Sets](#) subchapter for a detailed description.
- A **Time Set** is a time period definition, i.e. when the call forwarding has to be active. See the [Time Sets](#) subchapter for a detailed description.
- A **Source Set** is a list of number patterns that will be matched against the calling party number; if the calling number matches the call forwarding will be executed. See the [Source Sets](#) subchapter for a detailed description.
- A **B-Number Set** is a list of number patterns that will be matched against the called party number; if the callee number matches the call forwarding will be executed. See the [B-Number Sets](#) subchapter for a detailed description.

7.4.4.1 Configuring Destination Sets

Click on *Manage Destination Sets* to see a list of available sets. The *quickset_cfu* has been implicitly created during our creation of a simple call forward. You can edit it to add more destinations, or you can create a new destination set.

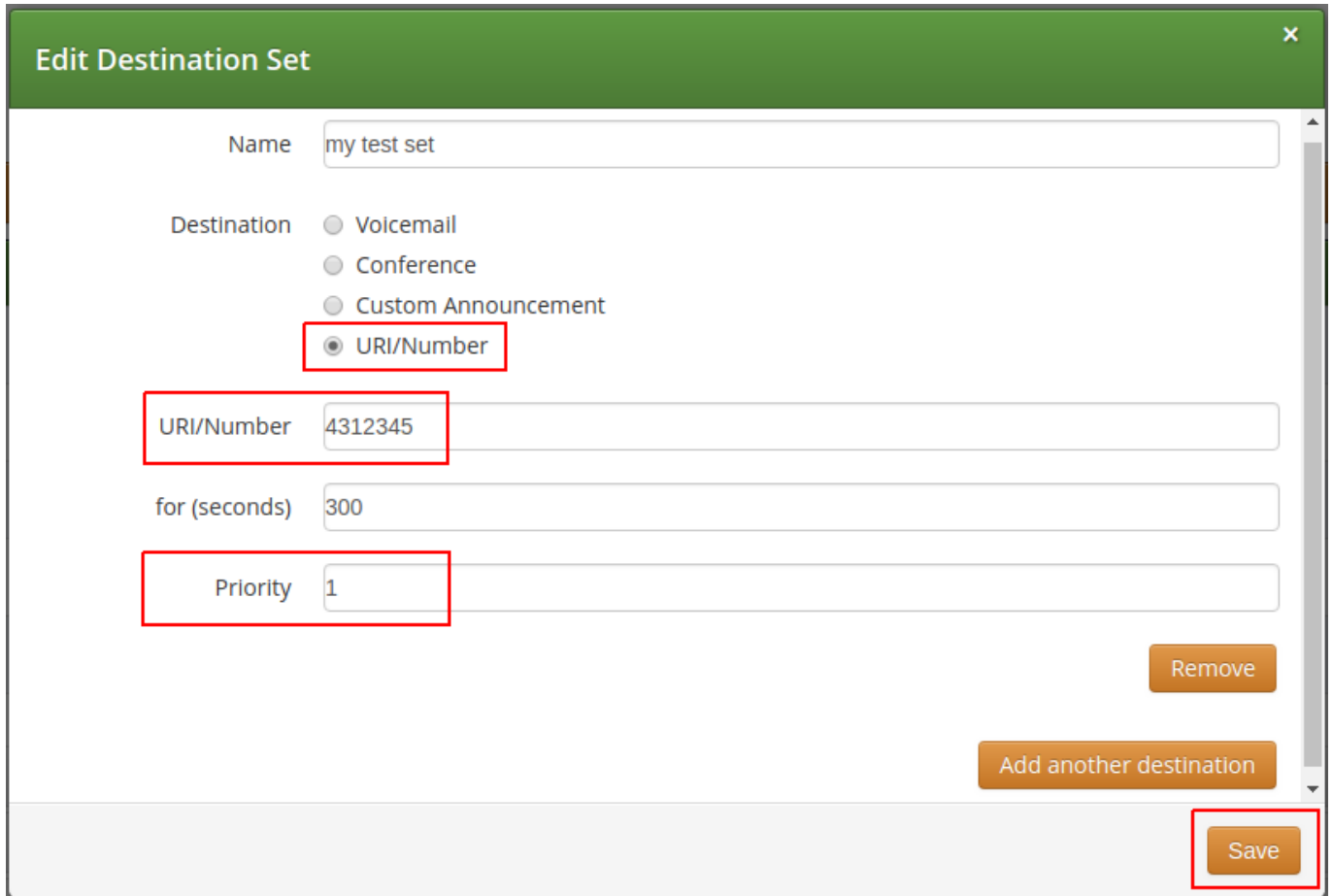

Edit Destination Set

Name

Destination Voicemail
 Conference
 Custom Announcement
 URI/Number

URI/Number

for (seconds)

Priority

When you close the *Destination Set Overview*, you can now assign your new set in addition or instead of the *quickset_cfu* set.

Edit Call Forward Unconditional ✕

during Time Set

from Source Set

to B-Number Set

Destination Set

Press *Save* to store your settings.

7.4.4.2 Configuring Time Sets

Click on *Manage Time Sets* in the advanced call-forward menu to see a list of available time sets. By default there are none, so you have to create one.

You need to provide a *Name*, and a list of *Periods* where this set is active. If you only set the top setting of a date field (like the *Year* setting in our example above), then it's valid for just this setting (like the full year of *2013* in our case). If you provide the bottom setting as well, it defines a period (like our *Month* setting, which means from beginning of April to end of September). For example, if a CF is set with the following timeset: "hour { 10-12 } minute { 20-30 }", the CF will be matched within the following time ranges:

- from 10.20am to 10:30am
- from 11.20am to 11:30am
- from 12.20am to 12:30am



Important

the period is a *through* definition, so it covers the full range. If you define an *Hour* definition *8-16*, then this means from *08:00* to *16:59:59* (unless you filter the *Minutes* down to something else).

If you close the *Time Sets* management, you can assign your new time set to the call forwards you're configuring.

7.4.4.3 Configuring Source Sets

Once the *Advanced View* of the call forward definition has been opened, you will need to press the *Manage Source Sets* button to start defining new Source Sets or managing an existing one. The following image shows the Source Set definition dialog:

The screenshot shows the 'Edit Source Set' interface. The form is titled 'Edit Source Set' in a green header. Below the header, there are several input fields and buttons:

- Name:** A text input field containing 'Test Source Number'.
- Mode:** A dropdown menu currently set to 'whitelist'.
- Is regex:** A checkbox that is currently unchecked.
- Source:** Two text input fields. The first contains '43*' and the second contains '4917655443322'. Both fields are highlighted with a red border in the image.
- Remove:** Two orange buttons, one next to each Source field, labeled 'Remove'.
- Add another source:** An orange button located below the second Source field.
- Save:** An orange button located at the bottom right of the form.

Figure 32: Creating a Call Forward Source Set

You will need to fill in the `Name` field first, the `Mode: whitelist` or `blacklist`, the `is_regex` flag and finally in the `Source` field you can enter:

- A simple phone number in E.164 format
- A pattern, in order to define a range of numbers. You can use `"*"` (matches a string of 0 to any number of characters), `"?"` (matches any single character), `"[abc]"` (matches a single character that is part of the explicitly listed set: a, b or c) and `"[0-9]"` (matches a single character that falls in the range 0 to 9) as wildcards, as usual in shell patterns. Examples:
 - `"431*"` (all numbers from Vienna / Austria)
 - `"49176[0-5]77*"` (German numbers containing fixed digits and a variable digit in 0-5 range in position 6)
 - `"43130120??"` (numbers from Vienna with fixed prefix and 2 digits variable at the end)
- A perl compatible regular expressions (only if `is_regex` if set). Capturing groups can be formed using parentheses and referenced in the `Destination Set` via `\1, \2, ...`
- The constant string "anonymous" that indicates a suppressed calling number (CLIR)

You can add more patterns to the Source Set by pressing the *Add another source* button. When you finished adding all patterns, press the *Save* button. You will then see the below depicted list of Source Sets:

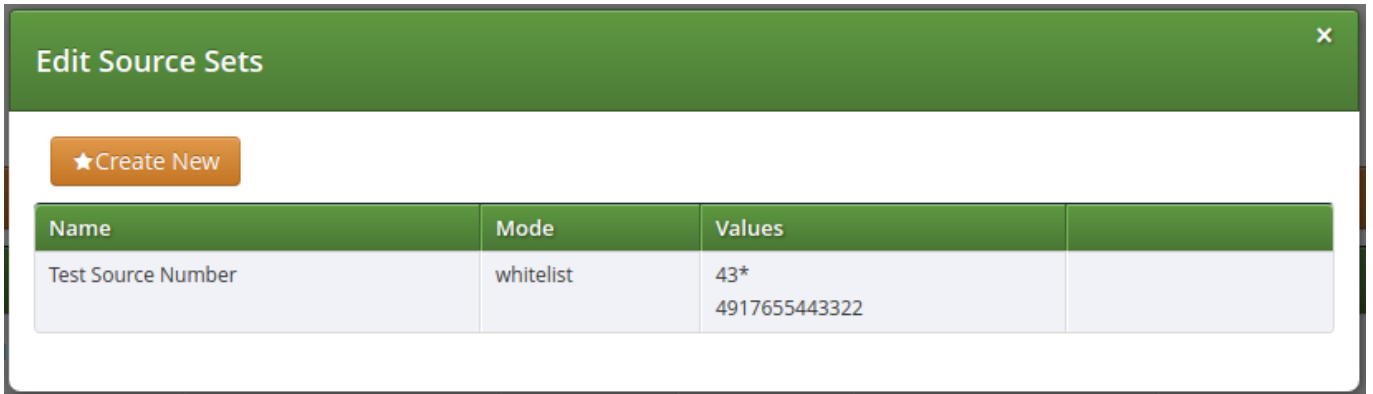

Name	Mode	Values
Test Source Number	whitelist	43* 4917655443322

Figure 33: List of Call Forward Source Sets

7.4.4.4 Configuring B-Number Sets

Once the *Advanced View* of the call forward definition has been opened, you will need to press the *Manage B-Number Sets* button to start defining new B-Number Sets or managing an existing one. The following image shows the B-Number Set definition dialog:

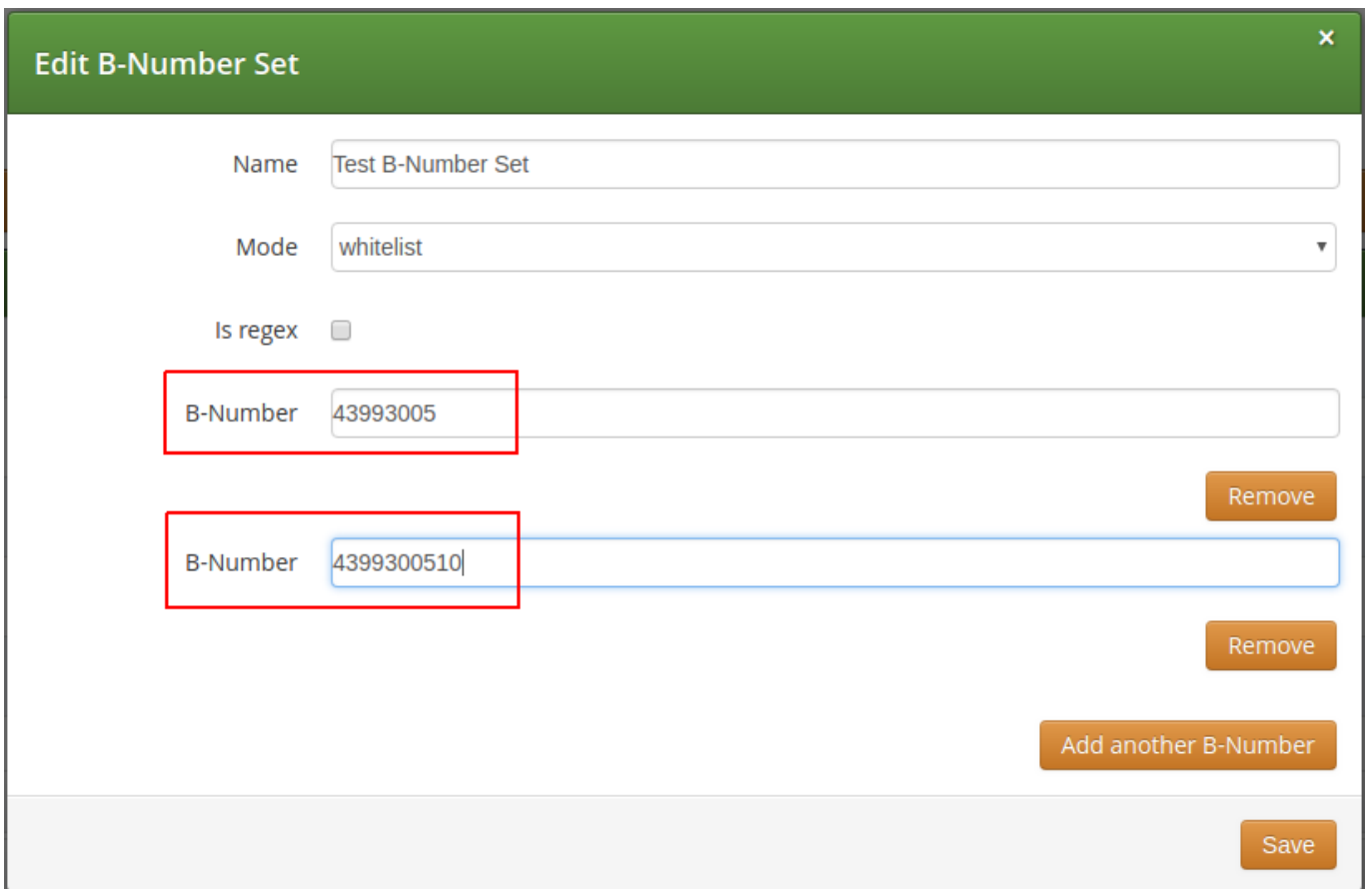

Name: Test B-Number Set

Mode: whitelist

Is regex:

B-Number: 43993005 [Remove]

B-Number: 4399300510 [Remove]

[Add another B-Number]

[Save]

Figure 34: Creating a Call Forward B-Number Set

You will need to fill in the `Name` field first, the `Mode: whitelist` or `blacklist`, the `is_regex` flag and finally in the `B-Number` field you can enter:

- A simple phone number in E.164 format
- A pattern, in order to define a range of numbers. You can use "*" (matches a string of 0 to any number of characters), "?" (matches any single character), "[abc]" (matches a single character that is part of the explicitly listed set: a, b or c) and "[0-9]" (matches a single character that falls in the range 0 to 9) as wildcards, as usual in shell patterns. Examples:
 - "431*" (all numbers from Vienna / Austria)
 - "49176[0-5]77*" (German numbers containing fixed digits and a variable digit in 0-5 range in position 6)
 - "43130120??" (numbers from Vienna with fixed prefix and 2 digits variable at the end)
- A perl compatible regular expressions (only if `is_regex` if set). Capturing groups can be formed using parentheses and referenced in the *Destination Set* via `\1`, `\2`,...

You can add more patterns to the B-Number Set by pressing the *Add another B-Number* button. When you finished adding all patterns, press the *Save* button. You will then see the below depicted list of B-Number Sets:

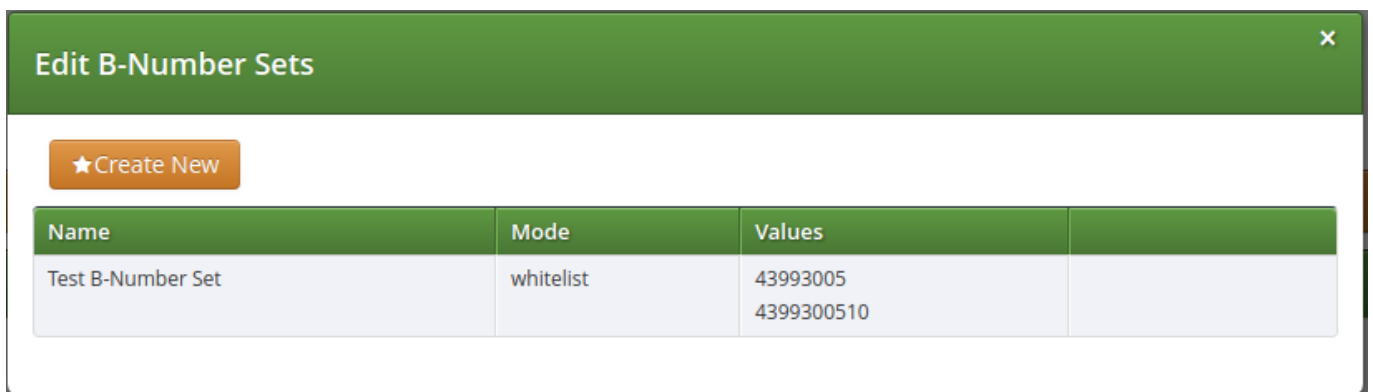

Edit B-Number Sets			
Name	Mode	Values	
Test B-Number Set	whitelist	43993005 4399300510	

Figure 35: List of Call Forward B-Number Sets

7.4.4.5 Finalizing the call forward definition

As additional step you can define a Destination Set as described in [Destination Sets](#) subchapter. For our example, we have defined the following Destination Set:

Name	Values
my test set	4312345@10.15.18.222 for 300s

Figure 36: List of Call Forward Destination Sets

A final step of defining the call forward settings is selecting a Destination, a Time Set, a Source Set and a B-Number Set, as shown in the image below. *Please note* that there is no specific Time Set selected in our example, that means the call forward rule is valid (as shown) <always>.

during Time Set: <always>
 from Source Set: Test Source Number
 to B-Number Set: Test B-Number Set
 Destination Set: my test set

[Remove] [Add destination/time sets]

[Manage Source Sets] [Manage Destination Sets] [Manage Time Sets] [Simple View] [Save] [Manage B-Number Sets]

Figure 37: Definition of a Call Forward with Source and Destination Sets

Once all the settings have been defined and the changes are saved, you will see the call forward entry (in our example: *Call Forward Unconditional*), with the names of the selected Destination, Time Set, Source Sets and B-Number Set provided, at *SubscriberPreferences* → *Call Forwards* location on the web interface:

Type	Answer Timeout	Timeset	Sources	To (B-Numbers)	New Destinations
Call Forward Unconditional		always	Test Source Number (whitelist) ⌵	Test B-Number Set (whitelist) ⌵	my test set ⌵
Call Forward Busy					
Call Forward Timeout					
Call Forward Unavailable					
Call Forward SMS					

Figure 38: List of Call Forward with Source and Destination Sets

7.5 Local Number Porting

The Sipwise C5 platform comes with two ways of accomplishing local number porting (LNP):

- one is populating the integrated LNP database with porting data,
- the other is accessing external LNP databases via the Sipwise LNP daemon using the LNP API.

Note

Accessing external LNP databases is available for PRO and CARRIER products only.

7.5.1 Local LNP Database

The local LNP database provides the possibility to define LNP Carriers (the owners of certain ported numbers or number blocks) and their corresponding LNP Numbers belonging to those carriers. It can be configured on the admin panel in *Settings* → *Number Porting* or via the API. The LNP configuration can be populated individually or via CSV import/export both on the panel and the API.

7.5.1.1 LNP Carriers

LNP Carriers are defined by an arbitrary *Name* for proper identification (e.g. *British Telecom*) and contain a *Prefix* which can be used as routing prefix in LNP Rewrite Rules and subsequently in Peering Rules to route calls to the proper carriers. The LNP

prefix is written to CDRs to identify the selected carrier for post processing and analytics purposes of CDRs. LNP Carrier entries also have an *Authoritative* flag indicating that the numbers in this block belong to the carrier operating Sipwise C5 . This is useful to define your own number blocks, and in case of calls to those numbers reject the calls if the numbers are not assigned to local subscribers (otherwise they would be routed to a peer, which might cause call loops). Finally the *Skip Rewrite* flag skips executing of LNP Rewrite Rules if no number manipulation is desired for an LNP carrier.

7.5.1.2 LNP Numbers

LNP Carriers contain one or more LNP Numbers. Those LNP Numbers are defined by a *Number* entry in E164 format (`<cc><ac><sn>`) used to match a number against the LNP database. Number matching is performed on a longest match, so you can define number blocks without specifying the full subscriber number (e.g. a called party number `431999123` is going to match an entry `431999` in the LNP Numbers).

For an LNP Numbers entry, an optional *Routing Number* can be defined. This is useful to translate e.g. premium 900 or toll-free 800 numbers to actual routing numbers. If a Routing Number is defined, the called party number is implicitly replaced by the Routing Number and the call processing is continued with the latter. For external billing purposes, the optional *Type* tag of a matched LNP number is recorded in CDRs.

An optional *Start Date* and *End Date* makes it possible to schedule porting work-flows up-front by populating the LNP database with certain dates, and the entries are only going to become active with those dates. Empty values for start indicate a start date in the past, while empty values for end indicate an end time in the future during processing of a call, allowing to define infinite date ranges. As intervals can overlap, the LNP number record with a start time closest to the current time is selected.

7.5.1.3 Enabling local LNP support

In order to activate Local LNP during routing, the feature must be activated in *config.yml*. Set `kamailio→proxy→lnp→enable` to *yes* and `kamailio→proxy→lnp→type` to *local*.

7.5.1.4 LNP Routing Procedure

When a call arrives at the system, the calling and called party numbers are first normalized using the *Inbound Rewrite Rules for Caller* and *Inbound Rewrite Rules for Callee* within the rewrite rule set assigned to the calling party (a local subscriber or a peer).

If the called party number is not assigned to a local subscriber, or if the called party is a local subscriber and has the subscriber/domain preference `lnp_for_local_sub` set, the LNP lookup logic is engaged, otherwise the call proceeds without LNP lookup. The further steps assume that LNP is engaged.

If the call originated from a peer, and the peer preference `caller_lnp_lookup` is set for this peer, then an LNP lookup is performed using the normalized calling party number. The purpose for that is to find the LNP prefix of the calling peer, which is then stored as `source_lnp_prefix` in the CDR, together with the selected LNP number's `type` tag (`source_lnp_type`). If the LNP lookup does not return a result (e.g. the calling party number is not populated in the local LNP database), but the peer preference `default_lnp_prefix` is set for the originating peer, then the value of this preference is stored in `source_lnp_prefix` of the CDR.

Next, an LNP lookup is performed using the normalized called party number. If no number is found (using a longest match), no further manipulation is performed.

If an LNP number entry is found, and the *Routing Number* is set, the called party number is replaced by the routing number. Also, if the *Authoritative* flag is set in the corresponding LNP Carrier, and the called party number is not assigned to a local subscriber, the call is rejected. This ensures that numbers allocated to the system but not assigned to subscribers are dropped instead of routed to a peer.

Important



If the system is serving a local subscriber with only the routing number assigned (but not e.g. the premium number mapping to this routing number), the subscriber will not be found and the call will either be rejected if the called party premium number is within an authoritative carrier, or the call will be routed to a peer. This is due to the fact that the subscriber lookup is performed with the dialled number, but not the routing number fetched during LNP. So make sure to assign e.g. the premium number to the local subscriber (optionally in addition to the routing number if necessary using alias numbers) and do not use the LNP routing number mechanism for number mapping to local subscribers.

Next, if the LNP carrier does not have the *Skip Rewriting* option set, the *LNP Rewrite Rules for Callee* are engaged. The rewrite rule set used is the one assigned to the originating peer or subscriber/domain via the *rewrite_rule_set* preference. The variables available in the match and replace part are, beside the standard variables for rewrite rules:

- `${callee_lnp_prefix}`: The prefix stored in the LNP Carrier
- `${callee_lnp_basenum}`: The actual number entry causing the match (may be shorter than the called party number due to longest match)

Typically, you would create a rewrite rule to prefix the called party number with the *callee_lnp_prefix* by matching `^([0-9]+)$` and replacing it by `${callee_lnp_prefix}\1`.

Once the LNP processing is completed, the system checks for further preferences to finalize the number manipulation. If the originating local subscriber or peer has the preference *lnp_add_npdi* set, the Request URI user-part is suffixed with `;npdi`. Next, if the preference *lnp_to_rn* is set, the Request URI user-part is suffixed with `;rn=LNP_ROUTING_NUMBER`, where *LNP_ROUTING_NUMBER* is the *Routing Number* stored for the number entry in the LNP database, and the originally called number is kept in place. For example, if *lnp_to_rn* is set and the number *1800123* is called, and this number has a routing number *1555123* in the LNP database, the resulting Request-URI is `sip:1800123;rn=1555123@example.org`.

Finally, the *destination_lnp_prefix* in the CDR table is populated either by the prefix defined in the Carrier of the LNP database if a match was found, or by the *default_lnp_prefix* preference of the destination peer or subscriber/domain.

7.5.1.5 Blocking Calls Using LNP Data

The Sipwise C5 provides means to allow or block calls towards ported numbers that are hosted by particular LNP carriers. Please visit Section [7.3.2.2](#) in the handbook to learn how this can be achieved.

7.5.1.6 Transit Calls using LNP

If a call originated from a peer and the peer preference *force_outbound_calls_to_peer* is set to *force_nonlocal_lnp* (the *if callee is not local and is ported* selection in the panel), the call is routed back to a peer selected via the peering rules.

This ensures that if a number once belonged to your system and is ported out, but other carriers are still sending calls to you (e.g. selecting you as an anchor network), the affected calls can be routed to the carrier the number got ported to.

7.5.1.7 CSV Format

The LNP database can be exported to CSV, and in the same format imported back to the system. On import, you can decide whether to drop existing data prior to applying the data from the CSV.

The CSV file format contains the fields in the following order:

Table 4: LNP CSV Format

Name	Description
Carrier Name	The <i>Name</i> in the LNP Carriers table (string, e.g. <i>My Carrier</i>)
Carrier Prefix	The <i>Prefix</i> in the LNP Carriers table (string, e.g. <i>DD55</i>)
Number	The <i>Number</i> in the LNP Numbers table (E164 number, e.g. <i>1800666</i>)
Routing Number	The <i>Routing Number</i> in the LNP Numbers table (E164 number or empty, e.g. <i>1555666</i>)
Start	The <i>Start</i> in the LNP Numbers table (YYYY-MM-DD or empty, e.g. <i>2016-01-01</i>)
End	The <i>End</i> in the LNP Numbers table (YYYY-MM-DD or empty, e.g. <i>2016-12-30</i>)
Authoritative	The <i>Authoritative</i> flag in the LNP Carriers table (0 or 1)
Skip Rewrite	The <i>Skip Rewrite</i> flag in the LNP Carriers table (0 or 1)
Type	The <i>Type</i> tag in the LNP Numbers table (alphanumeric string, e.g. <i>mobile</i>)

7.5.1.8 Local LNP returned values

If a match in the local LNP table is found corresponding LNP Carrier code will be stored in CDR data.

Additionally two dedicated headers can be added to the outgoing SIP message:

- `P-NGCP-LNP-Number`: The returned LNP number, if any
- `P-NGCP-LNP-Status`: The LNP query return code (200 if successful, 404 if no entry found)

This feature is not enabled by default, but can be activated with the following parameters:

- `kamailio→proxy→lnp→add_reply_headers→enable : no`

- kamailio→proxy→lnp→add_reply_headers→number : *P-NGCP-LNP-Number*
- kamailio→proxy→lnp→add_reply_headers→status : *P-NGCP-LNP-Status*

7.6 Emergency Mapping

As opposed to the [Simple Emergency Number Handling](#) solution, Sipwise C5 supports an advanced emergency call handling method, called *emergency mapping*. The main idea is: instead of obtaining a statically assigned emergency prefix / suffix from subscriber preferences, Sipwise C5 retrieves an emergency routing prefix from a central emergency call routing table, according to the current location of the calling subscriber.

The following figure shows the overview of emergency call processing when using *emergency mapping* feature:

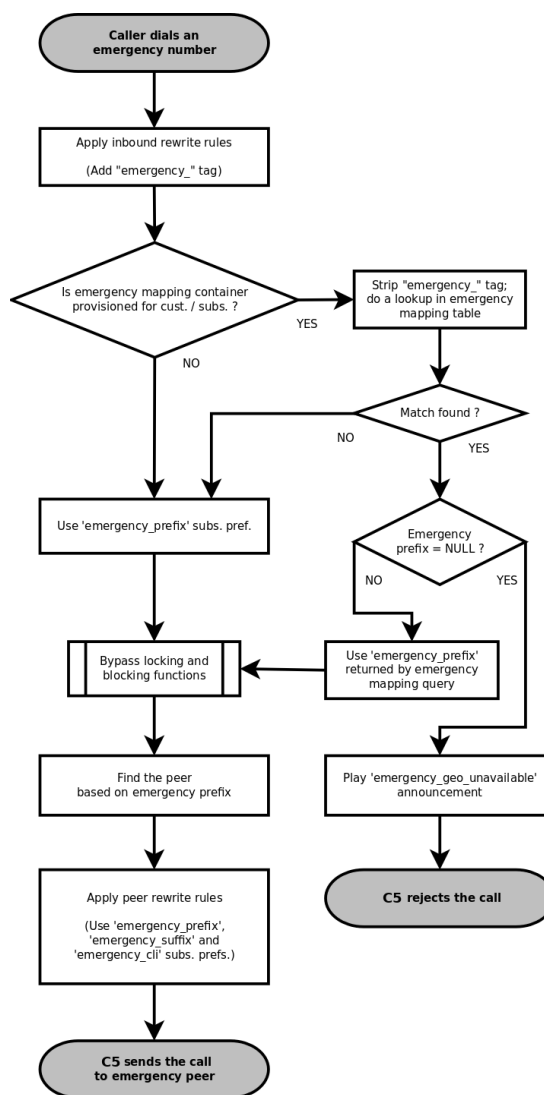

Figure 39: Emergency Call Handling with Mapping

7.6.1 Emergency Mapping Description

Emergency numbers per geographic location are mapped to different routing prefixes not deriveable from an area code or the emergency number itself. This is why a **global emergency mapping table** related to resellers is introduced, allowing to map emergency numbers to their geographically dependent routing numbers.

The geographic location is referenced by a location ID, which has to be populated by a north-bound provisioning system. No towns, areas or similar location data is stored on Sipwise C5 platform. The locations are called *Emergency Containers* on NGCP.

The actual emergency number mapping is done per location (per *Emergency Container*), using the so-called *Emergency Mapping* entries. An *Emergency Mapping* entry assigns a routing prefix, valid only in a geographic area, to a generic emergency number (for example *112* in Europe, *911* in the U.S.A.) or a country specific one (for example *133*).

Note

As of mr4.5 version, Sipwise C5 performs an exact match on the emergency number in the emergency routing table.

Emergency Containers may be assigned to various levels of the client hierarchy within NGCP. The following list shows such levels with each level overriding the settings of the previous one:

1. Customer or Domain
2. Customer Location, which is a territory representing a subset of the customer's subscribers, defined as one or more IP subnets.
3. Subscriber

Note

Please be aware that *Customer Location* is not necessarily identical to the "location" identified through an *Emergency Container*.

Once the emergency routing prefix has been retrieved from the emergency mapping table, call processing continues in the same way as in case of simple emergency call handling.

7.6.2 Emergency Mapping Configuration

The administrative web panel of Sipwise C5 provides the configuration interface for emergency mapping. Please navigate to *Settings* → *Emergency Mapping* menu item first, in order to start configuring the mapping.

An *Emergency Container* must be created, before the mapping entries can be defined. Press *Create Emergency Container* to start this. An example of a container is shown here:

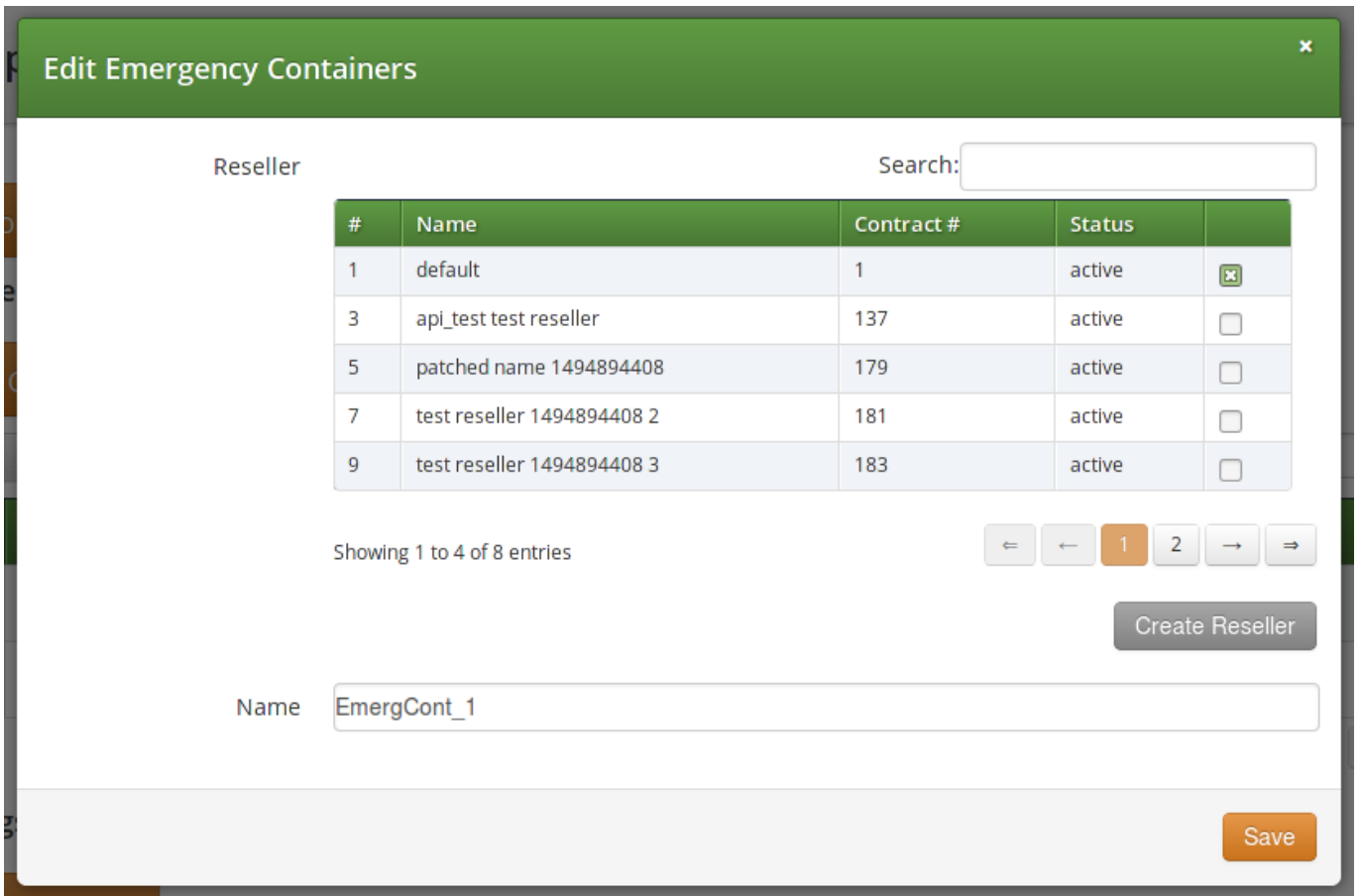

Figure 40: Creating an Emergency Container

You have to select a Reseller that this container belongs to, and enter a Name for the container, which is an arbitrary text.

Tip

The platform administrator has to create as many containers as the number of different geographic areas (locations) the subscribers are expected to be in.

As the second step of emergency mapping provisioning, the *Emergency Mapping* entries must be created. Press *Create Emergency Mapping* to start this step. An example is shown here:

Emergency Mapping Container

Search:

#	Reseller	Name	
1	default	EmergCont_1	<input checked="" type="checkbox"/>
3	default	EmergCont_2	<input type="checkbox"/>

Showing 1 to 2 of 2 entries

Create Emergency Mapping Container

Code

Prefix

Save

Figure 41: Creating an Emergency Mapping Entry

The following parameters must be set:

- **Container:** select an emergency mapping container (i.e. a location ID)
- **Code:** the emergency number that subscribers will dial
- **Prefix:** the routing prefix that belongs to the particular emergency service within the selected location

Once all the necessary emergency mappings have been defined, the platform administrator will see a list of containers and mapping entries:

Emergency Mappings

← Back
★ Download CSV
★ Upload CSV

Emergency Containers

★ Create Emergency Container

Show 5 entries Search:

#	Reseller	Name
1	default	EmergCont_1
3	default	EmergCont_2

Showing 1 to 2 of 2 entries

Emergency Mappings

★ Create Emergency Mapping

Show 5 entries Search:

#	Container	Reseller	Emergency Number	Emergency Prefix
1	EmergCont_1	default	133	E1_133_
3	EmergCont_1	default	144	E1_144_
5	EmergCont_2	default	133	E2_133_

Figure 42: Emergency Mapping List

The emergency number mapping is now defined. As the next step, the platform administrator has to assign the emergency containers to *Customers / Domains / Customer Locations* or *Subscribers*. We'll take an example with a *Customer*: select the customer, then navigate to *Details* → *Preferences* → *Number Manipulations*. In order to assign a container, press the *Edit* button and then select one container from the drop-down list:

The screenshot shows the 'Customer #205 - Preferences' page. Under the 'Number Manipulations' section, there is a table with the following data:

Attribute	Name	Value	
emergency_prefix	Emergency Prefix variable		
emergency_suffix	Emergency Suffix variable		
emergency_cli	Emergency CLI		
emergency_mapping_container	Emergency Mapping Container	EmergCont_2	Edit

Figure 43: Assigning an Emergency Mapping Container

Rewrite Rules for Emergency Mapping

Once emergency containers and emergency mapping entries are defined, Sipwise C5 administrator has to ensure that the proper number manipulation takes place, before initiating any emergency call towards peers.



Important

Please don't forget to define the rewrite rules for peers—particularly: *Outbound Rewrite Rules for Callee*—as described in [Normalize Emergency Calls for Peers](#) section of the handbook.

7.6.2.1 Emergency Calls Not Allowed

There is a special case when the dialed number is recognized as an emergency number, but the emergency number is not available for the geographic area the calling party is located in.

In such a case the emergency mapping lookup will return an emergency prefix, but the value of this will be NULL. Therefore the call is rejected and an announcement is played. The announcement is a newly defined sound file referred as `emergency_geo_unavailable`.

It is possible to configure the rejection code and reason in `/etc/ngcp-config/config.yml` file, the parameters are: `kamailio.proxy.early_rejects.emergency_invalid.announce_code` and `kamailio.proxy.early_reject`

7.6.2.2 Bulk Upload or Download of Emergency Mapping Entries

The Sipwise C5 offers the possibility to upload / download emergency mapping entries in form of CSV files. This operation is available for each reseller, and is very useful if a reseller has many mapping entries.

Downloading Emergency Mapping List

One has to navigate to *Settings* → *Emergency Mapping* menu and then press the *Download CSV* button to get the list of mapping entries in a CSV file. First the reseller must be selected, then the *Download* button must be pressed. As an example, the entries shown in "Emergency Mapping List" picture above would be written in the file like here below:

```
EmergCont_1,133,E1_133_  
EmergCont_1,144,E1_144_  
EmergCont_2,133,E2_133_
```

The **CSV file** has a plain text format, each line representing a mapping entry, and contains the following **fields**:

- Container name, as defined in *Emergency Containers*
- Emergency Number
- Emergency Prefix

Uploading Emergency Mapping List

Uploading a CSV file with emergency mapping entries may be started after pressing the *Upload CSV* button. The following data must be provided:

- **Reseller**: selected from the list
- **Upload mapping**: the CSV file must be selected after pressing the *Choose File* button
- **Purge existing**: an option to purge existing emergency mapping entries that belong to the selected reseller, before populating the new mapping data from the file

Upload mapping (None)

Reseller Search:

#	Name	Contract #	Status	
1	default	1	active	<input type="checkbox"/>
3	api_test test reseller	137	active	<input type="checkbox"/>
5	patched name 1494894408	179	active	<input type="checkbox"/>
7	test reseller 1494894408 2	181	active	<input type="checkbox"/>

Showing 1 to 4 of 8 entries

Purge existing

Figure 44: Uploading Emergency Mapping Data

The CSV file for the upload has the same format as the one used for download.

7.7 Emergency Priorization

The Sipwise C5 can potentially host *privileged subscribers* that offer emergency or at least prioritized services (civil defence, police etc.). In case of an emergency, the platform has to be free'd from any SIP flows (calls, registrations, presence events etc.) which do not involve those privileged subscribers.

Such an exceptional condition is called **emergency mode** and it can be activated for all domains on the system, or only for selected domains.

Once emergency mode is activated, Sipwise C5 will immediately apply the following restrictions on new SIP requests or existing calls:

- Any SIP requests (calls, registrations etc.) from subscribers within the affected domains, who are not marked as privileged, are rejected.
- Any calls from peers not targeting privileged subscribers are rejected.

- Any active calls which do not have a privileged subscriber involved are terminated.

Calls from non-privileged subscribers to emergency numbers are still allowed.

7.7.1 Call-Flow with Emergency Mode Enabled

Typical call-flows of emergency mode will be shown in this section of the handbook. We have the following assumptions:

- Emergency prioritization has been enabled on system-level
- There is a domain for which the emergency mode has been activated
- There is a privileged subscriber in that domain
- A generic peering connection has been configured for non-emergency calls
- A dedicated peering connection has been configured for emergency calls

The examples do not show details of SIP messages, but rather give a high-level overview of the call-flows.

1. A **non-privileged** subscriber makes a call **to another non-privileged subscriber**. Result: the call will be **rejected**.

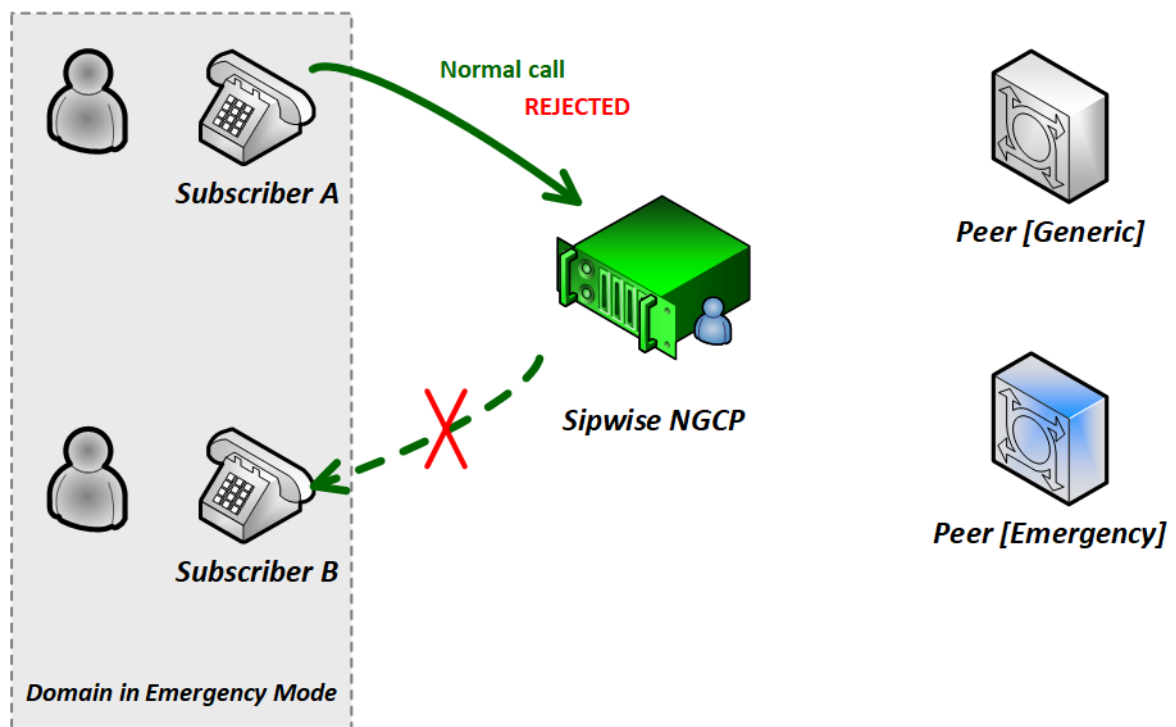

Figure 45: Call-flow in Emergency Mode 1. (Std to Std)

2. A **non-privileged** subscriber makes a call **to an external subscriber (via peer)**. Result: the call will be **rejected**.

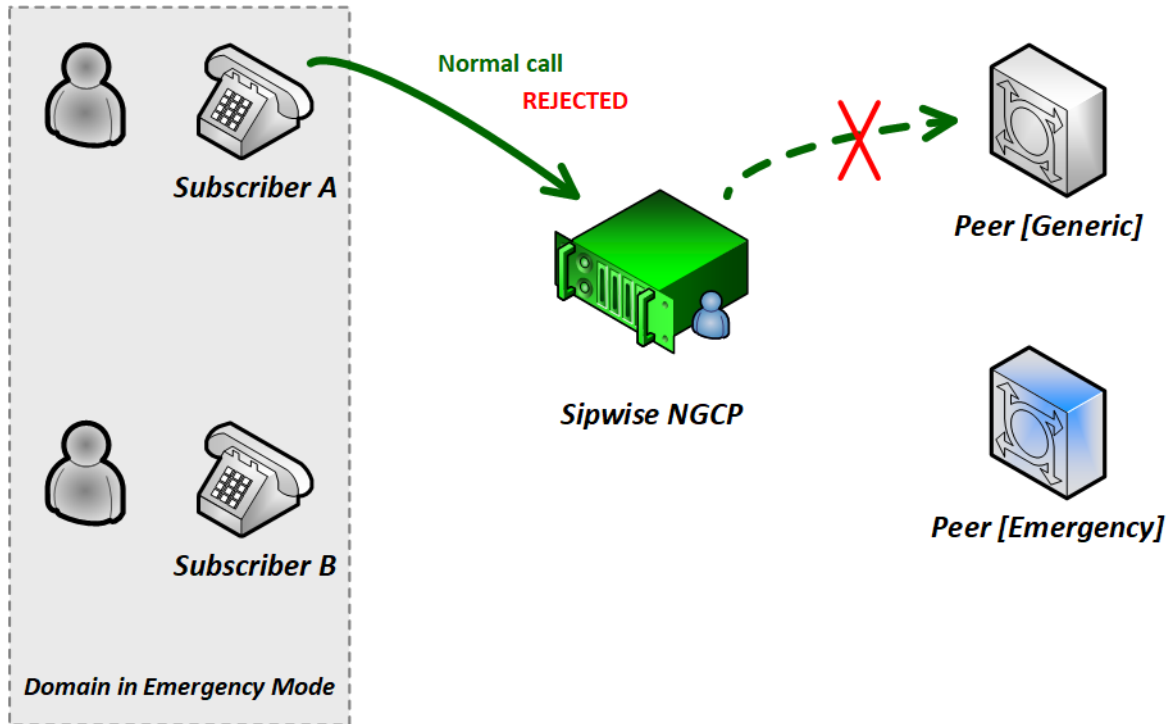

Figure 46: Call-flow in Emergency Mode 2. (Std to Peer)

3. A **non-privileged** subscriber makes a call **to a privileged subscriber**. Result: the call will be **accepted**.

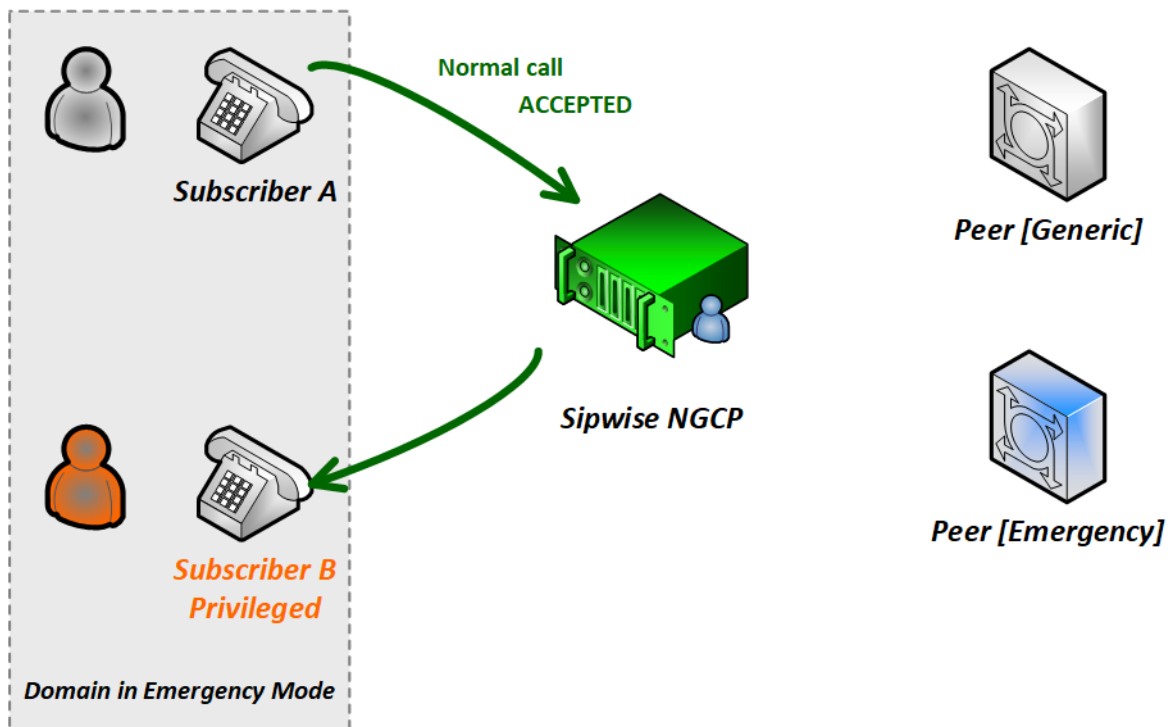

Figure 47: Call-flow in Emergency Mode 3. (Std to Priv)

4. A **non-privileged** subscriber makes a call to an emergency number. Result: the call will be **accepted**.

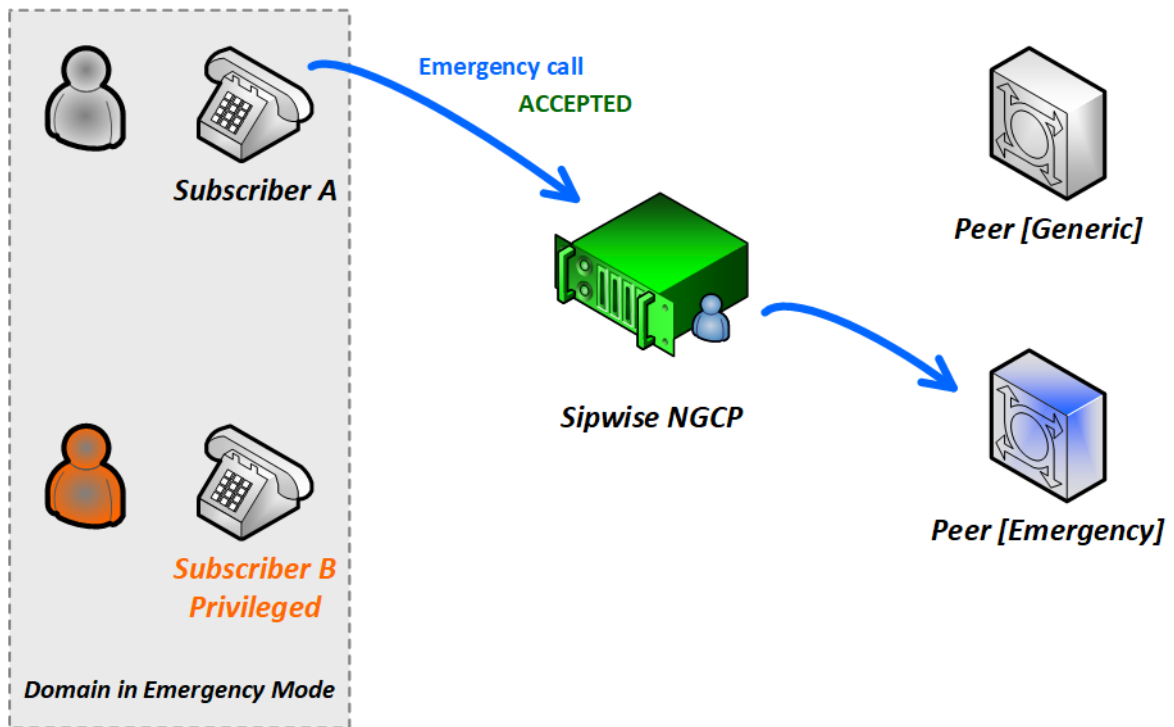

Figure 48: Call-flow in Emergency Mode 4. (Std to Emerg)

5. A **privileged** subscriber makes a call to a non-privileged subscriber. Result: the call will be **accepted**.

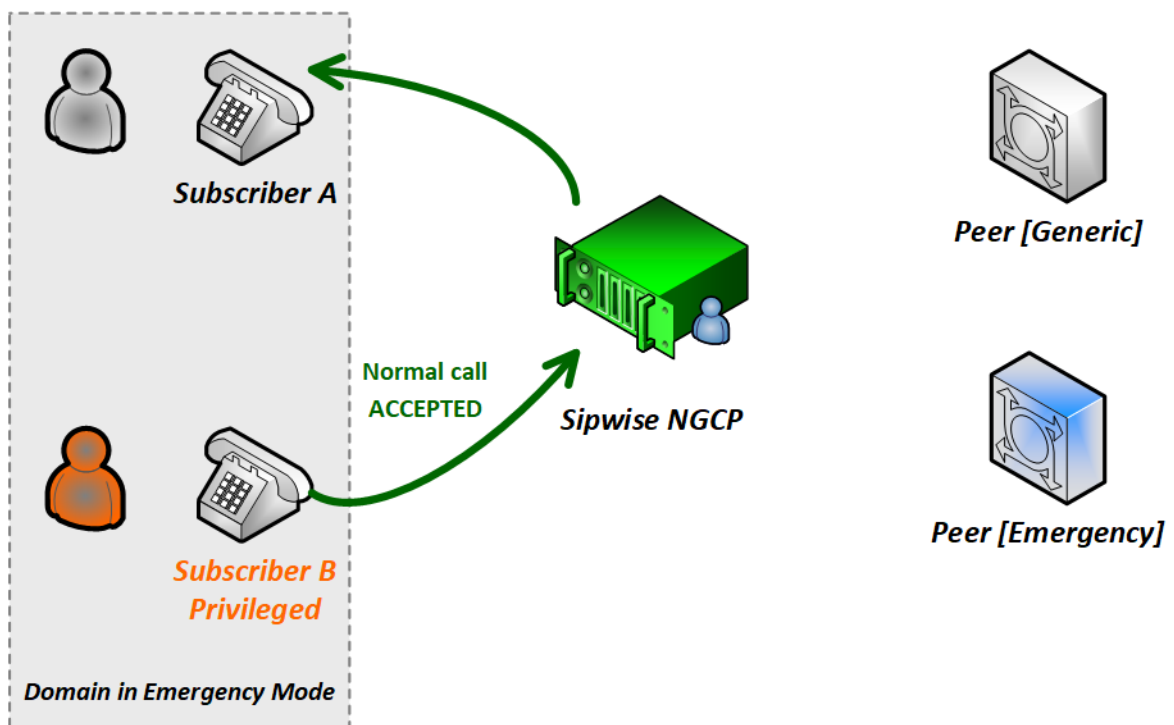

Figure 49: Call-flow in Emergency Mode 5. (Priv to Std)

6. A **privileged** subscriber makes a call **to an external subscriber (via peer)**. Result: the call will be **accepted**.

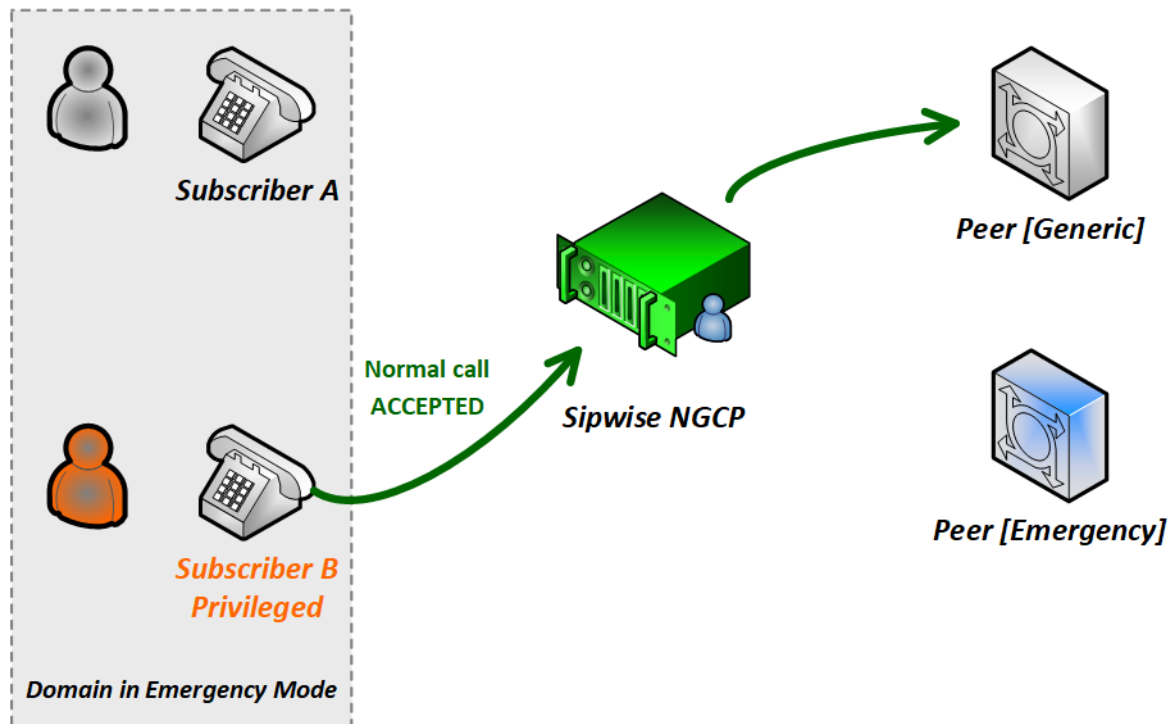

Figure 50: Call-flow in Emergency Mode 6. (Priv To Peer)

7.7.2 Configuration of Emergency Mode

The platform operator has to perform 2 steps of configuration so that the emergency mode can be activated. After the configuration is completed it is necessary to explicitly activate emergency mode, which can be accomplished as described in Section 7.7.3 later.

1. System-level Configuration

The emergency prioritization function must be enabled for the whole system, otherwise emergency mode can not be activated. The platform operator has to set `kamailio.proxy.emergency_priorization.enabled` configuration parameter value to "yes" in the main configuration file `/etc/ngcp-config/config.yml`. Afterwards changes have to be applied in the usual way, with the command: `ngcpcfg apply "Enabled emergency prioritization"`

In order to learn about other parameters related to emergency prioritization please refer to Section B.1.13 part of the handbook.

2. Subscriber-level Configuration

The platform operator (or any administrator user) has the capability to declare a subscriber privileged, so that the subscriber can initiate and receive calls when emergency mode has been activated on the NGCP. In order to do that the administrator has to navigate to *Settings* → *Subscribers* → *select the subscriber* → *Details* → *Preferences* → *Internals* → *emergency_priorization* on the **administrative web interface**, and press the *Edit* button.

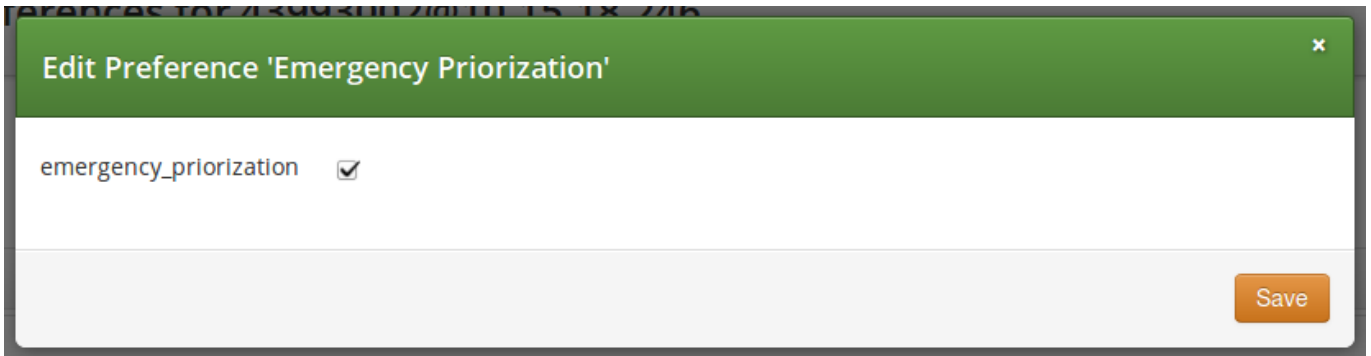

Figure 51: Emergency Priorization of Subscriber

The checkbox *emergency_priorization* has to be ticked and then press the *Save* button.

The same privilege can be added via the **REST API** for a subscriber: a HTTP PUT/PATCH request must be sent on `/api/subscriber` resource and the `emergency_priorization` property must be set to `"true"`.

7.7.3 Activating Emergency Mode

The platform operator can activate emergency mode for a single or multiple domains in 3 different ways:

- via the administrative web interface
- via the REST API
- via a command-line tool



Important

The interruption of ongoing calls is only possible with the command-line tool! Activating emergency mode for domains via the web interface or REST API will only affect upcoming calls.

1. Activate emergency mode via web interface: this way of activation is more appropriate if only a single (or just a few) domain is affected. Please navigate to *Settings* → *Domains* → *select a domain* → *Preferences* → *Internals* → *emergency_mode_enabled* → *Edit*.

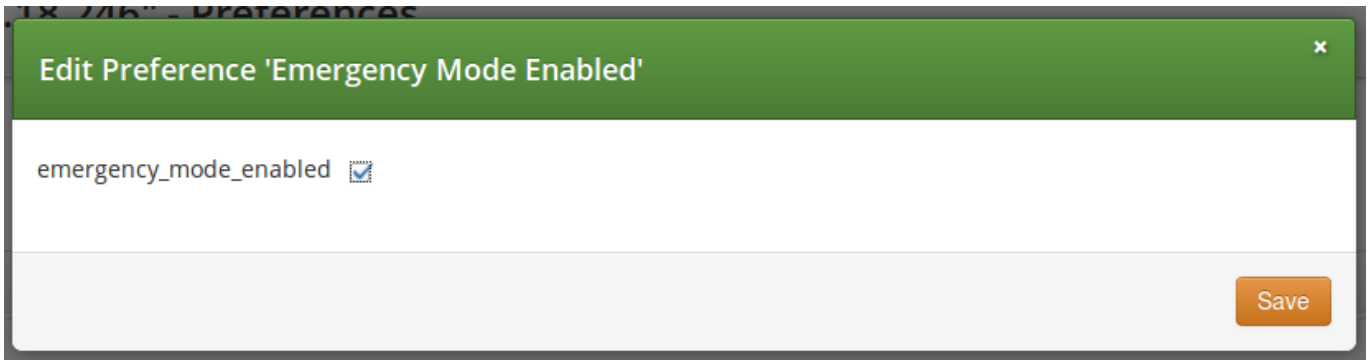

Figure 52: Activate Emergency Mode of Domain

The checkbox `emergency_mode_enabled` has to be ticked and then press the `Save` button.

2. Activate emergency mode via REST API: this way of activation is more appropriate if only a single (or just a few) domain is affected.

For that purpose a HTTP PUT/PATCH request must be sent on `/api/domainpreferences/id` resource and the `emergency_mode_enabled` property must be set to `"true"`.

3. Activate emergency mode using a command-line tool: Sipwise C5 provides a built-in script that may be used to enable/disable emergency mode for some particular or all domains.

- Enable emergency mode:

```
> ngcp-emergency-mode enable <all|[domain1 domain2 ...]>
```

- Disable emergency mode:

```
> ngcp-emergency-mode disable <all|[domain1 domain2 ...]>
```

- Query the status of emergency mode:

```
> ngcp-emergency-mode status <all|[domain1 domain2 ...]>
```

7.8 SIP Message Filtering

7.8.1 Header Filtering

Adding additional SIP headers to the initial INVITEs relayed to the callee (second leg) is possible by creating a [patchtt](#) file for the following template: `/etc/ngcp-config/templates/etc/ngcp-sems/etc/ngcp.sbcprofile.conf.tt2`. The following section can be changed:

```
header_filter=whitelist
header_list=[%IF kamailio.proxy.debug == "yes"%]P-NGCP-CFGTEST, [%END%]
P-R-Uri,P-D-Uri,P-Preferred-Identity,P-Asserted-Identity,Diversion,Privacy,
Allow,Supported,Require,RAck,RSeq,Rseq,User-Agent,History-Info,Call-Info
[%IF kamailio.proxy.presence.enable == "yes"%],Event,Expires,
Subscription-State,Accept[%END%][%IF kamailio.proxy.allow_refer_method
== "yes"%],Referred-By,Refer-To,Replaces[%END%]
```

By default the system will remove from the second leg all the SIP headers which are not in the above list. If you want to keep some additional/custom SIP headers, coming from the first leg, into the second leg you just need to add them at the end of the `header_list=` list. After that, as usual, you need to apply the changes. In this way the system will keep your headers in the INVITE sent to the destination subscriber/peer.



Warning

DO NOT TOUCH the list if you don't know what you are doing.

7.8.2 Codec Filtering

Sometimes you may need to filter some audio CODEC from the SDP payload, for example if you want to force your subscribers to do not talk a certain codecs or force them to talk a particular one. To achieve that you just need to change the `/etc/ngcp-config/config.yml`, in the following section:

```
sdp_filter:
  codecs: PCMA,PCMU,telephone-event
  enable: yes
  mode: whitelist
```

In the example above, the system is removing all the audio CODECS from the initial INVITE except G711 alaw,ulaw and telephone-event. In this way the callee will be notified that the caller is able to talk only PCMA. Another example is the `blacklist` mode:

```
sdp_filter:
  codecs: G729,G722
  enable: yes
  mode: blacklist
```

In this way the G729 and G722 will be removed from the SDP payload. In order to apply the changes, run

```
ngcpcfg apply 'Enable CODEC filtering'
```

7.8.3 Enable History and Diversion Headers

It may be useful and mandatory - specially with NGN interconnection - to enable SIP History header and/or Diversion header for outbound requests to a peer or even for on-net calls. In order to do so, you should enable the following preferences in Domain's and Peer's Preferences:

- Domain's Preferences: `inbound_uprn` = **Forwarder's NPN**
- Peer's Preferences: `outbound_history_info` = **UPRN**
- Peer's Preferences: `outbound_diversion` = **UPRN**
- Domain's Preferences: `outbound_history_info` = **UPRN** (if you want to allow History Header for on-net call as well)
- Domain's Preferences: `outbound_diversion` = **UPRN** (if you want to allow Diversion Header for on-net call as well)

7.8.4 User Agent Filtering

It could be useful to filter the received REGISTER and INVITE messages based on the User Agent header, for example if you want to force your subscribers to use certain types of devices. To achieve that configuration system wide you just need to change the `/etc/ngcp-config/config.yml`, in the following section:

```
kamailio:
  proxy:
    block_useragents:
      action: reject
      enable: yes
      mode: whitelist
      ua_patterns:
        - Yealink.*
```

In the example above, the system is allowing all the messages which have User Agent header starting with *Yealink*. All the others will be rejected with a *403 Forbidden message*. To silently drop the received message it is possible to specify the *drop* action instead of the default *reject*. Another example is the `blacklist` mode:

```
kamailio:
  proxy:
    block_useragents:
      action: drop
      enable: yes
      mode: blacklist
      ua_patterns:
        - friendly-scanner
```

In this example the system will block all the messages which have User Agent header equal to *friendly-scanner*. Because of the *drop* action this messages will be silently dropped, without providing any feedback to the sender. As usual, in order to apply the changes, run

```
ngcpcfg apply 'Enable User-Agent filtering'
```

Regardless of the system-wide configuration (UA filtering enabled or not), it is possible to define a specific User Agent filtering for each Domain or Subscriber. In order to do so, you should configure the following fields in Domain's or Subscriber's Preferences:

- `ua_filter_list`: Contains wildcard list of allowed or denied SIP User-Agents matched against the User-Agent header.
- `ua_filter_mode`: Specifies the operational mode of the SIP User-Agent Filter List: Blacklist or Whitelist.
- `ua_reject_missing`: Rejects any request if no User-Agent header is given.

In case of rejection a message with code `kamailio.proxy.early_rejects.block_admin.announce_code` and reason `kamailio.proxy.early_rejects.block_admin.announce_reason` will be sent back to the subscriber.

7.9 SIP Trunking with SIPconnect

7.9.1 User provisioning

For the purpose of external SIP-PBX interconnect with Sipwise C5 the platform admin should create a subscriber with multiple aliases representing the numbers and number ranges served by the SIP-PBX.

- Subscriber username - any SIP username that forms an "email-style" SIP URI.
- Subscriber Aliases - numbers in the global E.164 format without leading plus.

To configure the Subscriber, go to *Settings*→*Subscribers* and click *Details* on the row of your subscriber. There, click on the *Preferences* button on top.

You should look into the *Number Manipulations* and *Access Restrictions* sections in particular, which control the calling and called number presentation.

7.9.2 Inbound calls routing

Enable preference *Number Manipulations*→*e164_to_ruri* for routing inbound calls to SIP-PBX. This ensures that the Request-URI will comprise a SIP-URI containing the dialed alias-number as user-part, instead of the user-part of the registered AOR (which is normally a static value).

7.9.3 Number manipulations

The following sections describe the recommended configuration for correct call routing and CLI presentation according to the SIPconnect 1.1 recommendation.

7.9.3.1 Rewrite rules

The SIP PBX by default inherits the domain dialplan which usually has rewrite rules applied to normal Class 5 subscribers with inbound rewrite rules normalizing the dialed number to the E.164 standard. If most users of this domain are Class 5 subscribers the dialplan may supply calling number in national format - see Section 6.7. While the SIP-PBX trunk configuration can be sometimes amended it is a good idea in sense of SIPconnect recommendation to send only the global E.164 numbers.

Moreover, in mixed environments with Sipwise C5 Cloud PBX sharing the same domain with SIP trunking (SIP-PBX) customers the subscribers may have different rewrite rules sets assigned to them. The difference is caused by the fact that the dialplan for Cloud PBX is fundamentally different from the dialplan for SIP trunks due to extension dialing, where the Cloud PBX subscribers use the break-out code to dial numbers outside of this PBX.

The SIPconnect compliant numbering plan can be accommodated by assigning Rewrite Rules Set to the SIP-PBX subscriber. Below is a sample Rewrite Rule Set for using the global E.164 numbers with plus required for the calling and called number format compliant to the recommendation.

INBOUND REWRITE RULE FOR CALLER

- Match Pattern: `^(00|\+)([1-9][0-9]+)$`
- Replacement Pattern: `\2`
- Description: `International to E.164`
- Direction: `Inbound`
- Field: `Caller`

INBOUND REWRITE RULE FOR CALLEE

- Match Pattern: `^(00|\+)([1-9][0-9]+)$`
- Replacement Pattern: `\2`
- Description: `International to E.164`
- Direction: `Inbound`
- Field: `Callee`

OUTBOUND REWRITE RULE FOR CALLER

- Match Pattern: `^([1-9][0-9]+)$`
- Replacement Pattern: `+\1`
- Description: `For the calls to SIP-PBX add plus to E.164`
- Direction: `Outbound`
- Field: `Caller`

OUTBOUND REWRITE RULE FOR CALLEE

- Match Pattern: `^ ([1-9] [0-9]+) $`
- Replacement Pattern: `+\1`
- Description: For the calls to SIP-PBX add plus to E.164
- Direction: Outbound
- Field: Callee

Assign the aforementioned Rewrite Rule Set to the SIP-PBX subscribers.



Warning

Outbound Rewrite Rules for Callee shall NOT be applied to the calls to normal SIP UAs like IP phones since the number with plus does not correspond to their SIP username.

7.9.3.2 User parameter

The following configuration is needed for your platform to populate the From and To headers and Request-URI of the INVITE request with "user=phone" parameter as per RFC 3261 Section 19.1.1 (if the user part of the URI contains telephone number formatted as a telephone-subscriber).

- Domain's Preferences: `outbound_from_user_is_phone = Y`
- Domain's Preferences: `outbound_to_user_is_phone = Y`

7.9.3.3 Forwarding number

The following is our common configuration that covers the calling number presentation in a variety of use-cases, including the incoming calls, on-net calls and Call Forward by the platform:

- Domain's Preferences: `inbound_uprn = Forwarder's NPN`
- Domain's Preferences: `outbound_from_user = UPRN (if set) or User-Provided Number`
- Domain's Preferences: `outbound_pai_user = UPRN (if set) or Network-Provided Number`
- Domain's Preferences: `outbound_history_info = UPRN` (if the called user expects History-Info header)
- Domain's Preferences: `outbound_diversion = UPRN` (if the called user expects Diversion header)
- Domain's Preferences: `outbound_to_user = Original (Forwarding) called user` if the callee expects the number of the subscriber forwarding the call, otherwise leave default.

The above parameters can be tuned to operator specifics as required. You can of course override these settings in the Subscriber Preferences if particular subscribers need special settings.

Tip

On outgoing call from SIP-PBX subscriber the Network-Provided Number (NPN) is set to the *cli* preference prefilled with main E.164 number. In order to have the full alias number as NPN on outgoing call set preference *extension_in_npn* = Y.

Externally forwarded call If the call forward takes place inside the SIP-PBX it can use one of the following specification for signaling the diversion number to the platform:

- using **Diversion** method (RFC 5806): configure Subscriber's Preferences: *inbound_uprn* = **Forwarder's NPN / Received Diversion**
- using **History-Info** method (RFC 7044): Sipwise C5 platform extends the History-Info header received from the PBX by adding another level of indexing according to the specification RFC 7044.

7.9.3.4 Allowed CLIs

- For correct calling number presentation on outgoing calls, you should include the pattern matching all the alias numbers of SIP-PBX or each individual alias number under the *allowed_clis* preference.
- If the signalling calling number (usually taken from From user-part, see *inbound_upn* preferences) does not match the *allowed_clis* pattern, the *user_cli* or *cli* preference (Network-Provided Number) will be used for calling number presentation.

7.9.4 Registration

SIP-PBX can use either Static or Registration Mode. While SIPconnect 1.1 continues to require TLS support at MUST strength, one should note that using TLS for signaling does not require the use of the SIPS URI scheme. SIPS URI scheme is obsolete for this purpose.

Static Mode While SIPconnect 1.1 allows the use of Static mode, this poses additional maintenance overhead on the operator. The administrator should create a static registration for the SIP-PBX: go to Subscribers, *Details*→*Registered Devices*→*Create Permanent Registration* and put address of the SIP-PBX in the following format: sip:username@ipaddress:5060 where username=username portion of SIP URI and ipaddress = IP address of the device.

Registration Mode It is recommended to use the Registration mode with SIP credentials defined for the SIP-PBX subscriber.

**Important**

The use of RFC 6140 style "bulk number registration" is discouraged. The SIP-PBX should register one AOR with email-style SIP URI. The Sipwise C5 will take care of routing the aliases to the AOR with *e164_to_ruri* preference.

7.9.4.1 Trusted Sources

If a SIP-PBX cannot perform the digest authentication, you can authenticate it by its source IP address in Sipwise C5. To configure the IP-based authentication, go to the subscriber's preferences (*Details*→*Preferences*→*Trusted Sources*) and specify the IP address of the SIP-PBX in the *Source IP* field.

To authenticate multiple subscribers from the same IP address, use the *From* field to distinguish these subscribers.

When this feature is configured for a subscriber, Sipwise C5 authenticates all calls that arrive from the specified IP address without challenging them.

**Important**

If the same IP address and the FROM field are mistakenly specified as trusted for different subscribers, Sipwise C5 will not know which subscriber to charge for the call and will randomly select one.

7.10 Trusted Subscribers

In some cases, when you have a device that cannot authenticate itself against Sipwise C5, you may need to create a *Trusted Subscriber*. Trusted Subscribers use IP-based authentication and they have a Permanent SIP Registration URI in order to receive messages from Sipwise C5.

In order to make a regular subscriber trusted, perform the following extra steps:

- Create a permanent registration via (*Subscribers*→*Details*→ *Registered Devices*→*Create Permanent Registration*)
- Add the IP address of the device as Trusted Source in your subscriber's preferences (*Details*→*Preferences*→*Trusted Sources*).

This way, all SIP messages coming from the device IP will be considered trusted (and get authenticated just by the source IP). All the SIP messages forwarded to the devices will be sent to the SIP URI specified in the subscriber's permanent registration.

7.11 Peer Probing

The basic way of selecting the appropriate peering server, where an outbound call can be routed to, has already been described in Section 6.6.2.3 of the handbook.

This chapter provides information on the *peer probing* feature of Sipwise C5 that is available since the mr5.4.1 release.

7.11.1 Introduction to Peer Probing Feature

The Sipwise C5 provides a web admin panel and API capabilities to configure peering servers in order to terminate calls to non-local subscribers. Those peering servers may become *temporarily unavailable* due to overloading or networking issues. The Sipwise C5 will fail over to another peering server (matching the corresponding peering rules) after a timeout configured at system level (see the `sems.sbc.outbound_timeout` configuration parameter; 6 sec by default), if no provisional response (a response with a code in the range of 100 to 199) is received for the outbound INVITE request.

Even if this timer is set much lower, like 3 sec, the call setup time is increased significantly. This is even more true if multiple peering servers fail at the same time, which will sum up the individual timeouts, finally *causing call setup times reach the order of tens of seconds*.

To optimize the call setup time in such scenarios, a new feature is implemented to *continuously probe peering servers* via SIP messages, and mark them as unavailable on timeout or when receiving unexpected response codes. Appropriate SIP response codes from the peering servers will mark them as available again.

Peering servers *marked as unavailable* are then *skipped during call routing* in the peering selection process, which significantly shortens the call setup times if peering servers fail.

7.11.2 Configuration of Peer Probing

The system administrator has to configure the peer probing feature in 2 steps:

1. System-level configuration enables the peer probing feature in general on the Sipwise C5 and determines the operational parameters, such as timeouts, the SIP method used for probing requests, etc.
2. Peering server configuration will add / remove a peering server to the list of probed endpoints.

7.11.2.1 System-level Configuration

The parameters of peer probing are found in the main system configuration file `/etc/ngcp-config/config.yml`. You can see the complete list of configuration parameters in Section [B.1.13](#) of the handbook, while the most significant ones are discussed here.

Enabling peer probing system-wide happens through the `kamailio.proxy.peer_probe.enable` parameter. If it is set to *yes* (which is the default value) then Sipwise C5 will consider probing of individual peering servers based on their settings.

Timeout of a single probing request can be defined through `kamailio.proxy.peer_probe.timeout` parameter. This is a value interpreted as seconds while Sipwise C5 will wait for a SIP response from the peering server. Default is 5 seconds.

The **probing interval** can be set through the `kamailio.proxy.peer_probe.interval` parameter. This is the time period in seconds that determines how often a probing request is sent to the peering servers. Default is 10 seconds.

The **SIP method** used for probing requests can be defined through `kamailio.proxy.peer_probe.method` parameter. Allowed values are: `OPTIONS` (default) and `INFO`.

Tip

The system administrator, in most of the cases, will not need to modify the default configuration values other than that of timeout and interval.

If no available peering server is found, the call is rejected with the response code and reason configured in `kamailio.proxy.early_rejects` and `kamailio.proxy.early_rejects.peering_unavailable.announce_reason`. If a sound file is configured within the *system sound set* assigned to the calling party, an announcement is played as early media before the rejection.

7.11.2.2 Individual Peering Server Configuration

When the peer probing feature is enabled on system-level, it is possible to add each individual peering server to the list of probed endpoints. You can change the probed status of a server in two ways:

Enable probing of a peering server via the admin web interface

1. Open the properties panel of a peering server: *Peerings* → *select a peering group* → *Details* → *select a peering server* → *Edit*
2. Tick the checkbox *Enable Probing*
3. Save changes

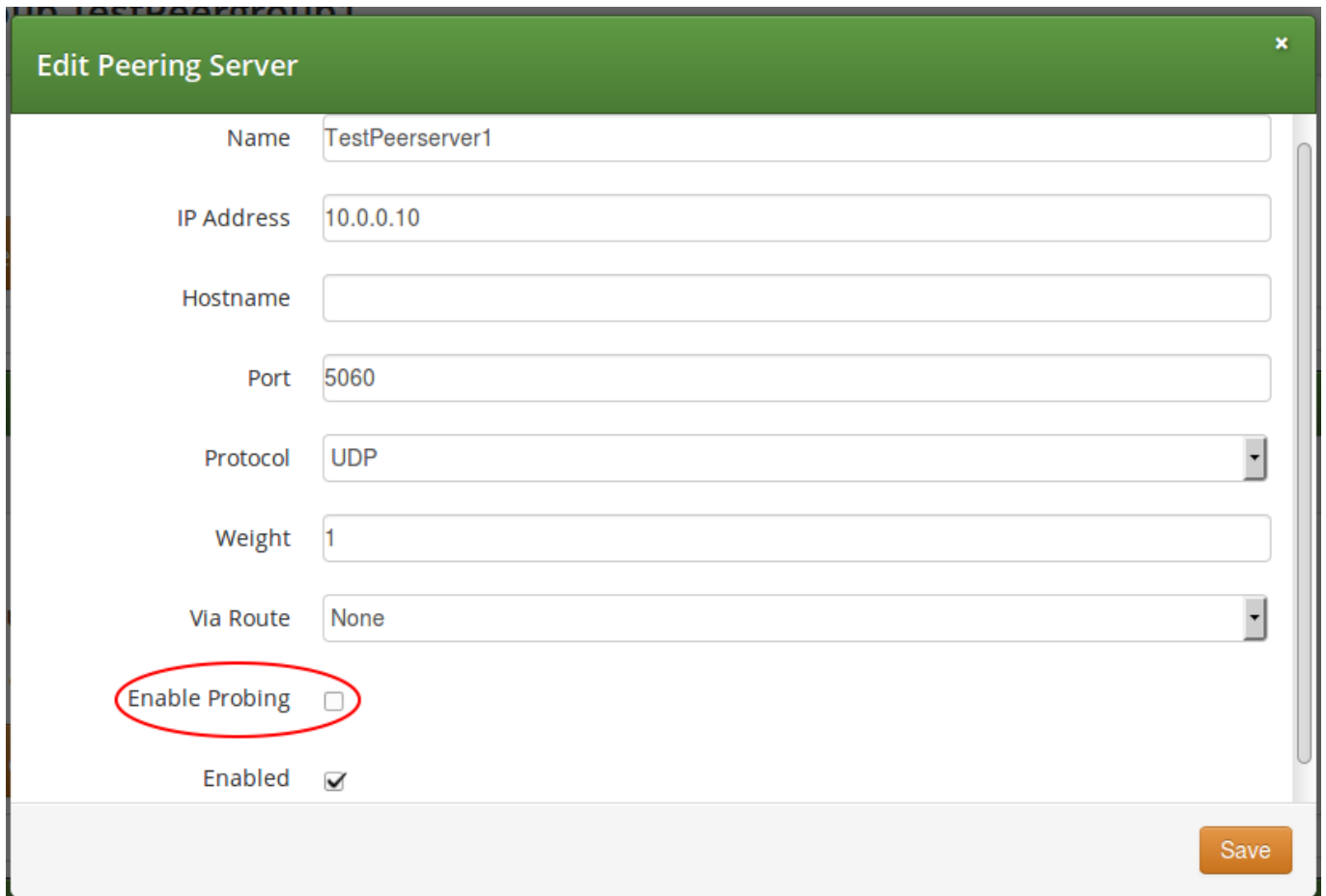

The screenshot shows a web form titled "Edit Peering Server". The form has a green header bar with the title and a close button. Below the header, there are several input fields and dropdown menus:

- Name: TestPeerserver1
- IP Address: 10.0.0.10
- Hostname: (empty)
- Port: 5060
- Protocol: UDP (dropdown)
- Weight: 1
- Via Route: None (dropdown)
- Enable Probing: (circled in red)
- Enabled:

At the bottom right of the form, there is an orange "Save" button.

Figure 53: Enable Probing of Peering Server

Enable probing of a peering server via the REST API

- when you *create a new peering server* you will use an HTTP *POST* request and the target URL:
https://<IP_of_NGCP>:1443/api/peeringservers
- when you *update an existing peering server* you will use an HTTP *PUT* or *PATCH* request and the target URL:
https://<IP_of_NGCP>:1443/api/peeringservers/id

In all cases you have to set the *probe* property to `true` in order to enable probing, and to `false` in order to disable probing.

Default value is `false` and this property may be omitted in a create/update request, which ensures backward compatibility of the `/api/peeringservers` API resource.

7.11.3 Monitoring of Peer Probing

Peering server states, such as "reachable" / "unreachable", are continuously stored in a time-series database (InfluxDB type) by Sipwise C5 Proxy nodes. It is possible to **graphically represent the state of peering servers** on NGCP's admin web interface, just like other system variables (like CPU and memory usage, number of registered subscribers, etc.). However this is not available by default and must be configured by Sipwise.

State changes of peering servers are also reported by means of **SNMP traps**. Each time the reachable state of one of the monitored peering servers changes, Sipwise C5 will send an SNMP trap, raising or clearing the alarm.

The Sipwise MIB is extended by a table of peers per proxy, containing the peer ID and the peer name, along with the peer probe status. An external monitoring system can **poll the peers table via SNMP** to gather the peer status from each proxy's point of view.

The peer information for all nodes is stored in a table rooted at the OID `.1.3.6.1.4.1.34274.1.1.2.40.2.1` with the following OID path:

```
.iso.org.dod.internet.private.enterprises.sipwise.ngcp.ngcpObjects.ngcpMonitor. ←  
  ngcpMonitorPeering.psTable
```

The peer status is an indexed element of that table at the OID `.1.3.6.1.4.1.34274.1.1.2.40.2.1.7` with the following OID path:

```
.iso.org.dod.internet.private.enterprises.sipwise.ngcp.ngcpObjects.ngcpMonitor. ←  
  ngcpMonitorPeering.psTable.psEntry.psPeerStatus
```

Value of `psPeerStatus` can be:

- 0: unknown
- 1: administratively down
- 2: administratively up
- 3: probed, pending
- 4: probed, down
- 5: probed, up

7.11.4 Further Details for Advanced Users

Tip

This subchapter of the handbook is targeted on advanced system operators and Sipwise engineers and is not necessary to read in order to properly manage peer probing feature of NGCP.

7.11.4.1 Behaviour of Kamailio Proxy Instances

Each *kamailio-proxy* instance on the proxy nodes performs the probing individually for performance reasons. Each proxy holds its result in its cache to avoid central storage and replication of the probing results. Each proxy will send an SNMP trap if it detects a state change for a peering server, because proxies might be geographically distributed along with their load-balancers and can therefore experience different probing results.

Each peering server is cross-checked against the hash table filled during outbound probing requests and is skipped by call routing logic, if a match is found.

On start or restart of the *kamailio-proxy* instance, the probing will start after the first interval, and NOT immediately after start. In the first probing interval the proxy will always try to send call traffic to peering servers until the first probing round is finished, and will only then start to skip unavailable peering servers.

7.11.4.2 Changes to Kamailio Proxy Configuration

A new configuration template: `/etc/ngcp/config/templates/etc/kamailio/proxy/probe.cfg.tt2` is introduced to handle outbound probing requests.

7.11.4.3 Database Changes

A new DB column: `provisioning.voip_peer_hosts.probe` with type `TINYINT(1)` (boolean) is added to the DB schema.

A peer status change will populate the `kamailio.dispatcher` table, inserting the SIP URI in format `sip:$ip:$port;transport=...` in dispatcher group 100, which defines the probing group for peering servers.

Also the `kamailio.dispatcher.attrs` column is populated with a parameter `peerid=$id`. This ID is used during probing to load the peer preferences: `outbound_socket` and `lbrtp_set`, that are required to properly route the probing request.

7.12 Voicemail System

7.12.1 Accessing the IVR Menu

For a subscriber to manage his voicebox via IVR, there are two ways to access the voicebox. One is to call the URI `voicebox@yourdomain` from the subscriber itself, allowing password-less access to the IVR, as the authentication is already done on SIP level. The second is to call the URI `voiceboxpass@yourdomain` from any number, causing the system to prompt for a mailbox and the

PIN. The PIN can be set in the *Voicemail and Voicebox* section of the *Subscriber Preferences*.

7.12.1.1 Mapping numbers and codes to IVR access

Since access might need to be provided from external networks like PSTN/Mobile, and since certain SIP phones do not support calling alphanumeric numbers to dial `voicebox`, you can map any number to the voicebox URIs using rewrite rules.

To do so, you can provision a match pattern e.g. `^(00|\+)12345$` with a replace pattern `voicebox` or `voiceboxpass` to map a number to either password-less or password-based IVR access respectively. Create a new rewrite rule with the `Inbound` direction and the `Called` field in the corresponding rewrite rule set.

For inbound calls from external networks, assign this rewrite rule set to the corresponding incoming peer. If you also need to map numbers for on-net calls, assign the rewrite rule set to subscribers or the whole SIP domain.

7.12.1.2 External IVR access

When reaching `voiceboxpass`, the subscriber is prompted for her mailbox number and a password. All numbers assigned to a subscriber are valid input (primary number and any alias number). By default, the required format is in E.164, so the subscriber needs to enter the full number including country code, for example `4912345` if she got assigned a German number.

You can globally configure a rewrite rule in `config.yml` using `asterisk.voicemail.normalize_match` and `asterisk.voicemail.normalize_replace` allowing you to customize the format a subscriber can enter, e.g. having `^0([1-9][0-9]+)$` as match part and `49$1` as replace part to accept German national format.

7.12.2 IVR Menu Structure

The following list shows you how the voicebox menu is structured.

- 1 Read voicemail messages
 - 3 Advanced options
 - * 3 To Hear messages Envelope
 - * * Return to the main menu
 - 4 Play previous message
 - 5 Repeat current message
 - 6 Play next message
 - 7 Delete current message
 - 9 Save message in a folder
 - * 0 Save in new Messages
 - * 1 Save in old Messages
 - * 2 Save in Work Messages
 - * 3 Save in Family Messages

- * 4 Save in Friends Messages
- * # Return to the main menu
- 2 Change folders
 - 0 Switch to new Messages
 - 1 Switch to old Messages
 - 2 Switch to Work Messages
 - 3 Switch to Family Messages
 - 4 Switch to Friends Messages
 - # Get Back
- 3 Advanced Options
 - * To return to the main menu
- 0 Mailbox options
 - 1 Record your unavailable message
 - * 1 accept it
 - * 2 Listen to it
 - * 3 Rerecord it
 - 2 Record your busy message
 - * 1 accept it
 - * 2 Listen to it
 - * 3 Rerecord it
 - 3 Record your name
 - * 1 accept it
 - * 2 Listen to it
 - * 3 Rerecord it
 - 4 Record your temporary greetings
 - * 1 accept it / or re-record if one already exist
 - * 2 Listen to it / or delete if one already exist
 - * 3 Rerecord it
 - 5 Change your password
 - * To return to the main menu
- * Help
- # Exit

7.12.3 Type Of Messages

A message/greeting is a short message that plays before the caller is allowed to record a message. The message is intended to let the caller know that you are not able to answer their call. It can also be used to convey other information like when you will be available, other methods to contact you, or other options that the caller can use to receive assistance.

The IVR menu has three types of greetings.

7.12.3.1 Unavailable Message

The standard voice mail greeting is the "unavailable" greeting. This is used if you don't answer the phone and so the call is directed to your voice mailbox.

- You can record a custom unavailable greeting.
- If you have not recorded your unavailable greeting but have recorded your name, the system will play a generic message like: "Recorded name is unavailable."
- If you have not recorded your unavailable greeting, the phone system will play a generic message like: "Digits-of-number-dialed is unavailable".

7.12.3.2 Busy Message

If you wish, you can record a custom greeting used when someone calls you and you are currently on the phone. This is called your "Busy" greeting.

- You can record a custom busy greeting.
- If you have not recorded your busy greeting but have recorded your name, the phone system will play a generic message: "Recorded name is busy."
- If you have not recorded your busy greeting and have not recorded your name (see below), the phone system will play a generic message: "Digits-of-number-dialed is busy."

7.12.3.3 Temporary Greeting

You can also record a temporary greeting. If it exists, a temporary greeting will always be played instead of your "busy" or "unavailable" greetings. This could be used, for example, if you are going on vacation or will be out of the office for a while and want to inform people not to expect a return call anytime soon. Using a temporary greeting avoids having to change your normal unavailable greeting when you leave and when you come back.

7.12.4 Folders

The Voicemail system allows you to save and organize your messages into folders. There can be up to ten folders.

7.12.4.1 The Default Folder List

- 0 - New Messages
- 1 - Old Messages
- 2 - Work Messages
- 3 - Family Messages
- 4 - Friends Messages

When a caller leaves a message for you, the system will put the message into the "New Messages" folder. If you listen to the message, but do not delete the message or save the message to a different folder, it will automatically move the message to the "Old Messages" folder. When you first log into your mailbox, the Voicemail System will make the "New Messages" folder the current folder if you have any new messages. If you do not have any new messages the it will make the "Old Messages" folder the current folder.

7.12.5 Voicemail Languages Configuration

To add a new language or to change the pronunciation for an existing one, ensure that **mode=new** is defined in `/etc/ngcp-config/templates/etc/asterisk/say.conf.tt2`. Adjust the configuration in the same file using the manual in the beginning. Then, as usual, make the new configuration active.

7.12.6 Flowcharts with Voice Prompts

This section shows flowcharts of calls to the voicemail system. Flowcharts contain the name of prompts as they are identified among *Asterisk* voice prompts.

7.12.6.1 Listening to New Messages

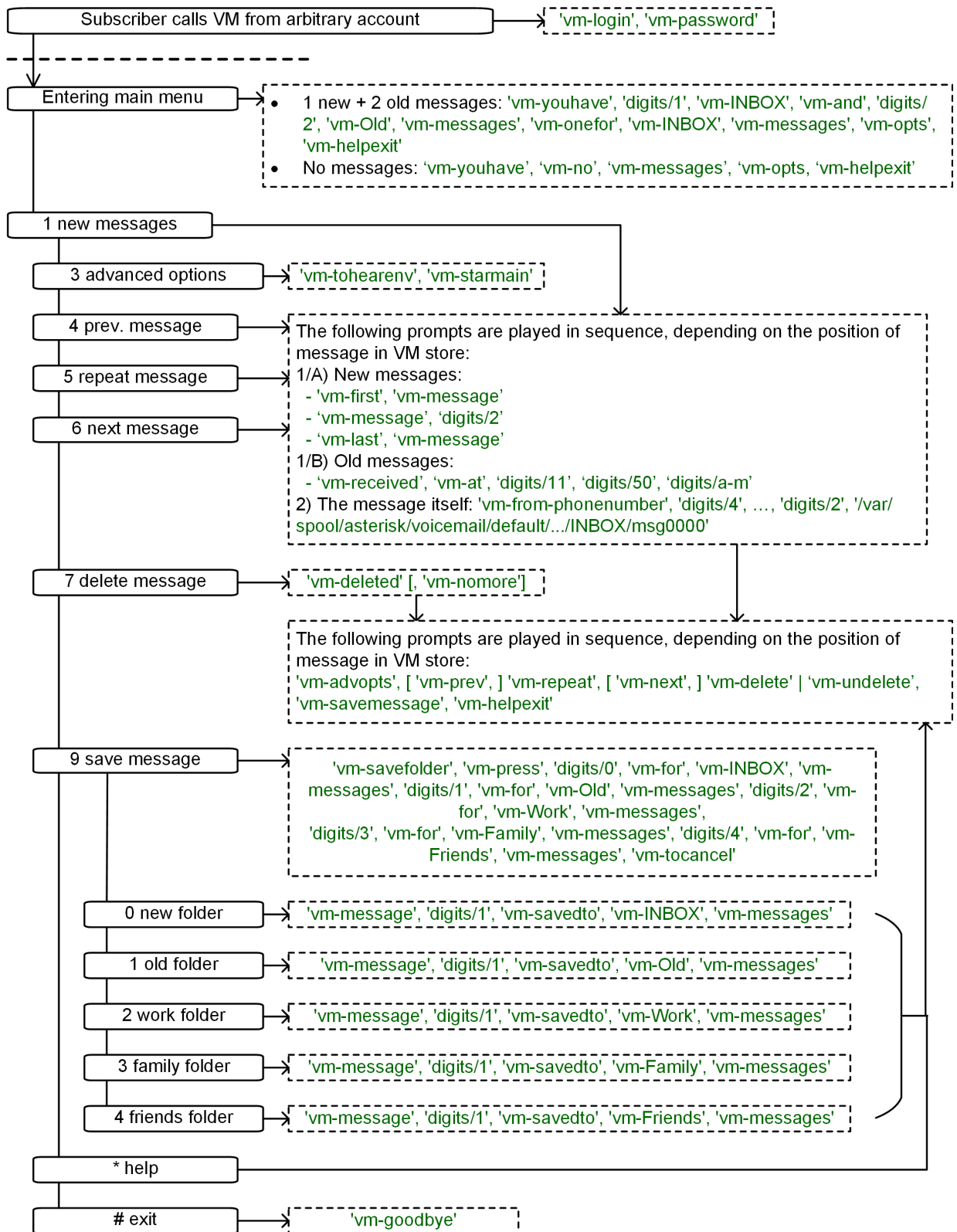

Figure 54: Flowchart of Listening to New Messages

7.12.6.2 Changing Voicemail Folders

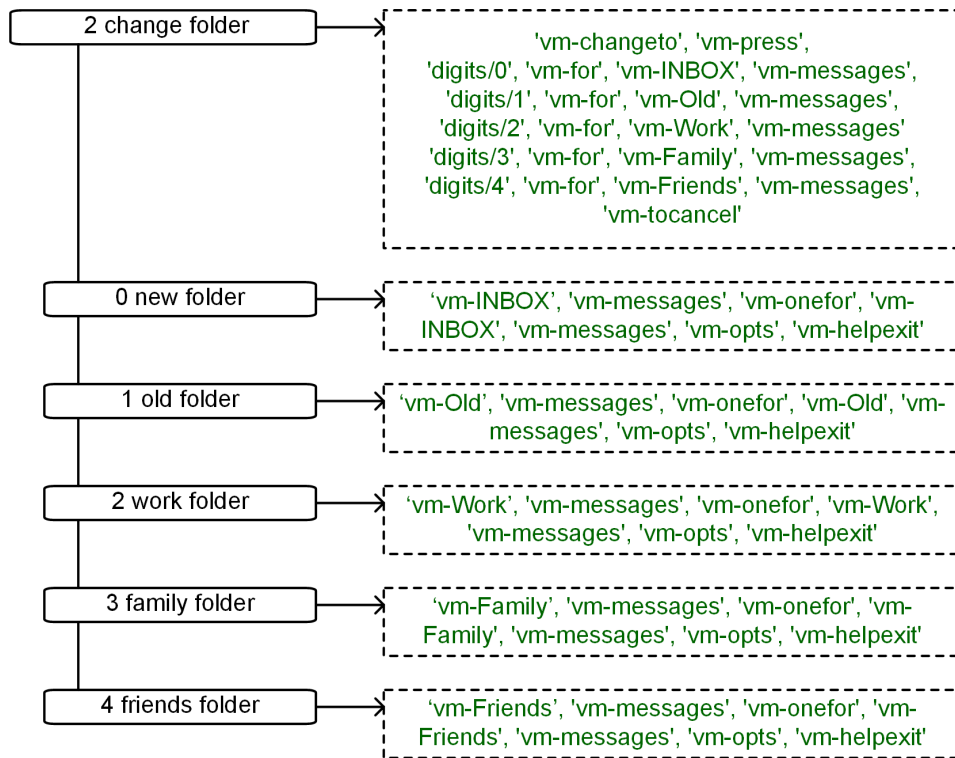

Figure 55: Flowchart of Changing Voicemail Folders

7.12.6.3 Mailbox Options

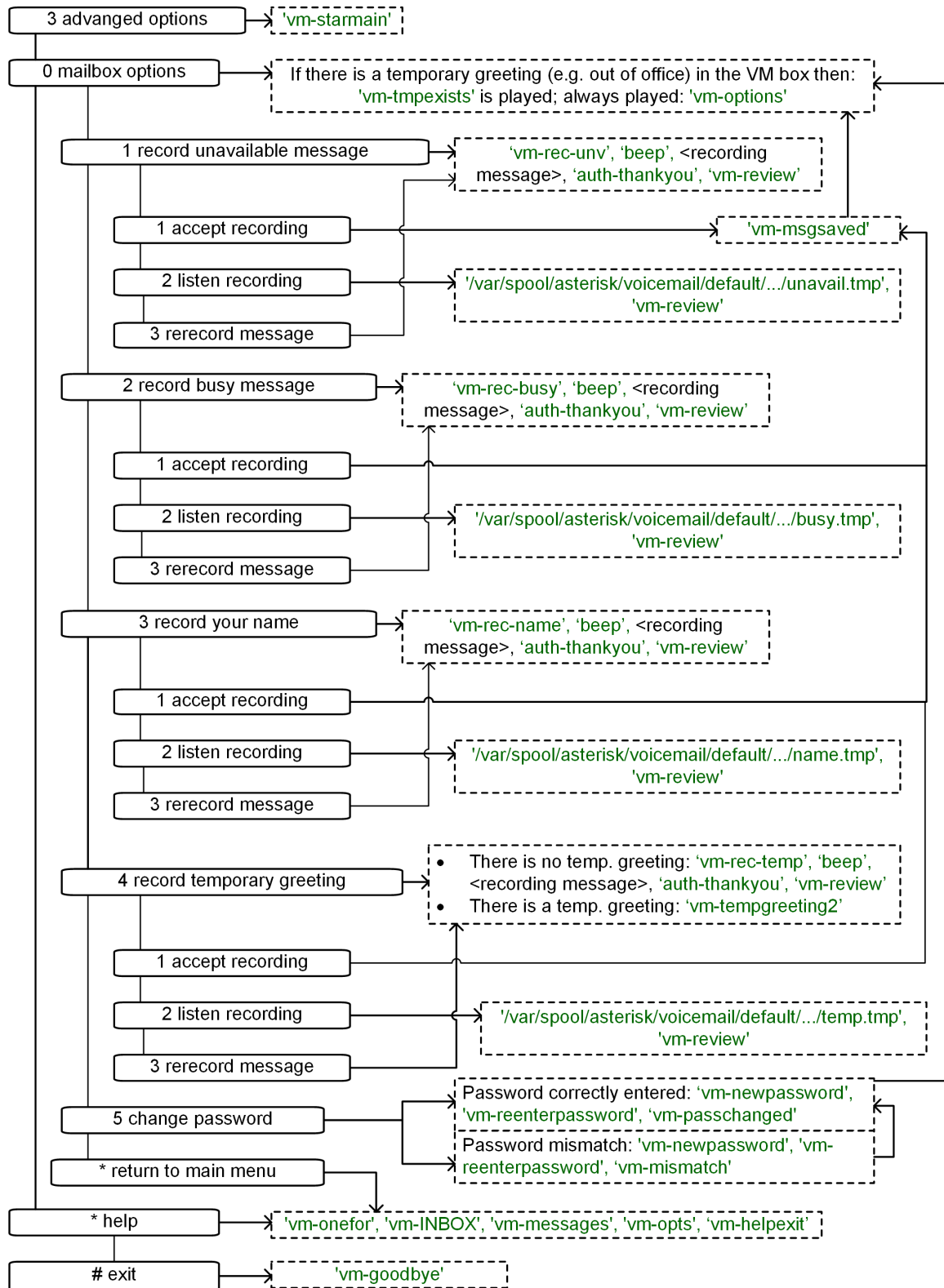

Figure 56: Flowchart of Changing Mailbox Options

7.12.6.4 Leaving a Message

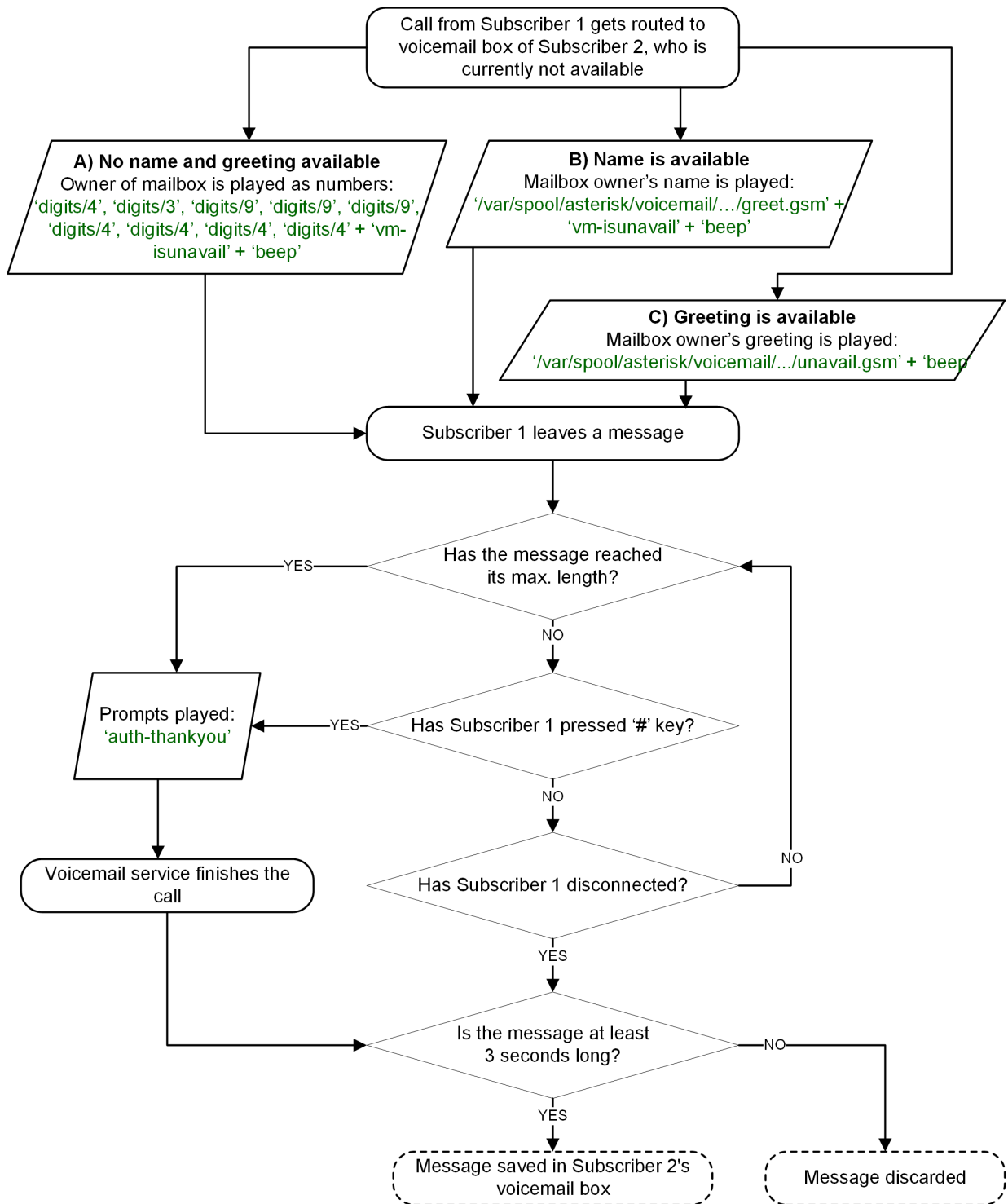
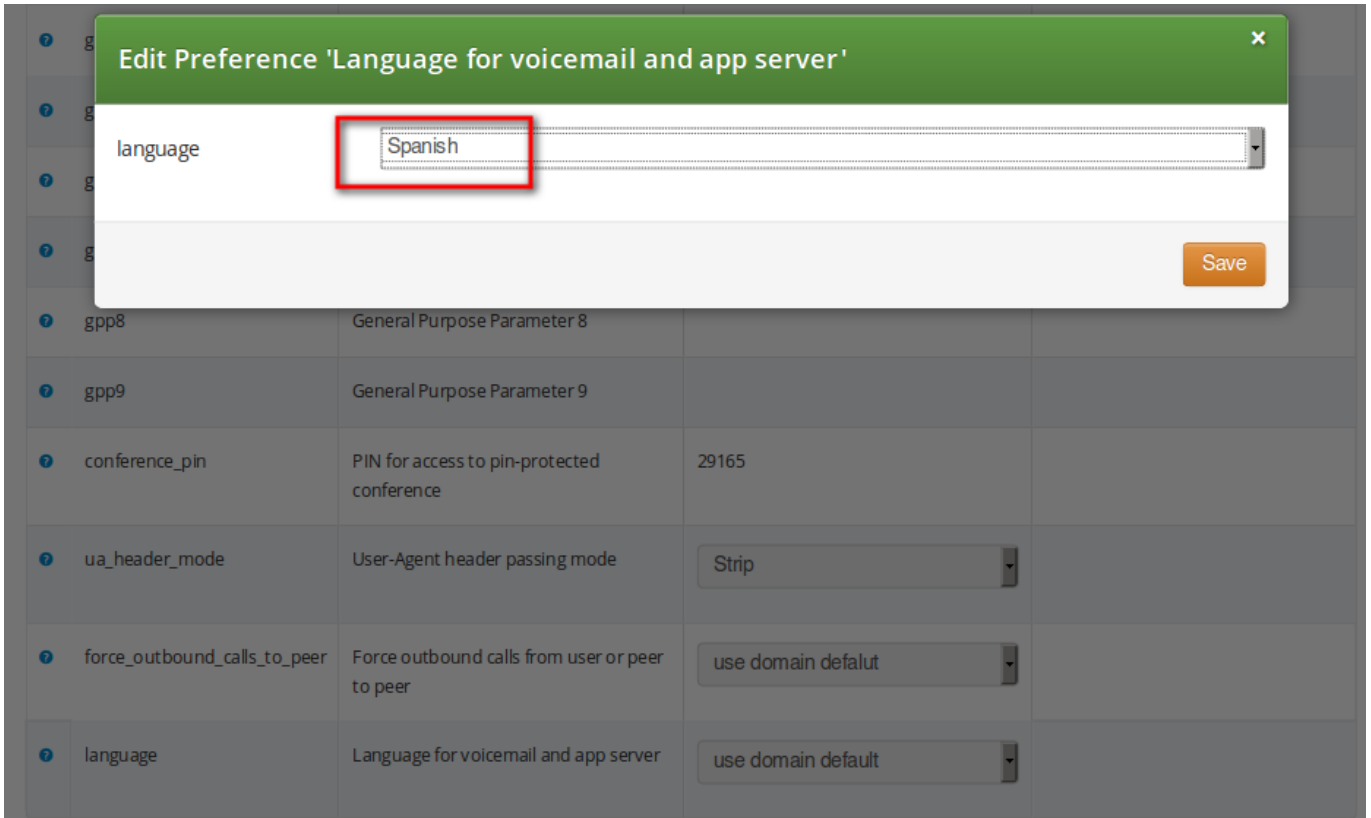

Figure 57: Flowchart of Leaving a Voice Message

7.13 Configuring Subscriber IVR Language

The language for the Voicemail system IVR or Vertical Service Codes (VSC) IVRs may be set using the subscriber or domain preference *language*.



The Sipwise C5 provides the pre-installed prompts for the Voicemail in the English, Spanish, French and Italian languages and the pre-installed prompts for the Vertical Service Codes IVRs in English only.

The other IVRs such as the Conference system and the error announcements use the Sound Sets configured in Sipwise C5 Panel and uploaded by the administrator in his language of choice.

7.14 Sound Sets

The Sipwise C5 provides the administrator with ability to upload the voice prompts such as conference prompts or call error announcements on the *Sound Sets page*. There is a preference *sound_set* in the *NAT and Media Flow Control* section on Domain and Subscriber levels to link subscribers to the sound set that they should hear (as usual the subscriber preference overrides the domain one). Additionally Sound Sets can be configured on Peer level in order to play a dedicated early reject prompt when an incoming call doesn't match any local subscriber. Sound Sets can be defined in *Settings*→*Sound Sets*. To create a new Sound Set, click *Create Sound Set*. Then click the *Files* button.

Logged in as administrator Language Logout

sip:wise NGCP Dashboard Home Monitoring & Statistics Settings

Sound Sets

← Back ★ Create Sound Set

Sound set successfully created

Show entries Search:

#	Reseller	Customer	Name	Description	
1	default		Conference		<input type="button" value="Edit"/> <input type="button" value="Delete"/> <input type="button" value="Files"/>
2	default		Early media rejects	Failed call attempt announcements	

Showing 1 to 2 of 2 entries

← 1 →

Note

You may use 8 or 16 bit mono WAV audio files for all of the voice prompts.

7.14.1 Sound_Set and Contract_Sound_Set Usage

Sound_Set and *Contract_Sound_Set* are used for different purposes:

- *Contract_Sound_Set* is a customer-specific sound set used for the Cloud PBX features. It can be assigned only to a PBX customer.
- *Sound_Set* contains general prompts, e.g. for the Conference, Music on Hold, Early Rejects, etc.

The Music on Hold prompts can be uploaded to both *Contract_Sound_Set* and *Sound_Set*. In this case, the one from the *Sound_Set* will take precedence. Vice versa, digits prompts in *Contract_Sound_Set* will take precedence.

7.14.2 Configuring Early Reject Sound Sets

The call error announcements are grouped under *Early Rejects* section. Unfold the section and click *Upload* next to the sound handles (Names) that you want to use. Choose a WAV file from your file system, and click the Loopplay setting if you want to play the file in a loop instead of just once. Click Save to upload the file.

early_rejects			
Name	Filename	Loop	
block_in		■	
block_out		■	
block_ncos		■	
block_override_pin_wrong		■	
locked_in		■	
locked_out		■	
max_calls_in		■	
max_calls_out		■	
max_calls_peer		■	
unauth_caller_ip		■	

The call error announcements are played to the user in early media hence the name "Early Reject". If you don't provide the sound files for any handles they will not be used and Sipwise C5 will fallback to sending the error response code back to the user.

The exact error status code and text are configurable in the `/etc/ngcp-config/config.yml` file, in `kamailio.proxy.early` section. Please look for the announcement handle listed in below table in order to find it in the configuration file.

Table 5: Early Reject Announcements

Handle	Description	Message played
announce_before_call_setup	This is an announcement that the calling party hears before the call is being actually sent to the destination. The feature can be activated with Applications / <code>play_announce_before_call_setup</code> domain or subscriber preference. Loopplay doesn't have effect on this element.	N/A (custom message, no default)
announce_before_cf	This is an announcement that the calling party hears before the call is being forwarded (Unconditional and Not Available cases) to the destination. The feature can be activated with Applications / <code>play_announce_before_cf</code> domain or subscriber preference.	N/A (custom message, no default)

Table 5: (continued)

Handle	Description	Message played
announce_before_recording	This is an announcement that the calling party hears before the call is actually sent to the destination and before the recording starts. The feature can be activated with Applications / play_announce_before_recording domain or subscriber preference. NAT and Media Flow Control / record_call preference has to be activated as well. Loopplay doesn't have effect on this element.	N/A (custom message, no default)
block_in	This is what the calling party hears when a call is made from a number that is blocked by the incoming block list (<i>adm_block_in_list</i> , <i>block_in_list</i> customer/subscriber preferences)	Your call is blocked by the number you are trying to reach.
block_out	This is what the calling party hears when a call is made to a number that is blocked by the outgoing block list (<i>adm_block_out_list</i> , <i>block_out_list</i> customer/subscriber preferences)	Your call to the number you are trying to reach is blocked.
block_ncos	This is what the calling party hears when a call is made to a number that is blocked by the NCOS level assigned to the subscriber or domain (the NCOS level chosen in <i>ncos</i> and <i>adm_ncos</i> preferences). <i>PLEASE NOTE</i> : It is not possible to configure the status code and text.	Your call to the number you are trying to reach is not permitted.
block_override_pin_wrong	Announcement played to calling party if it used wrong PIN code to override the outgoing user block list or the NCOS level for this call (the PIN set by <i>block_out_override_pin</i> and <i>adm_block_out_override_pin</i> preferences)	The PIN code you have entered is not correct.
callee_busy	Announcement played on incoming call to the subscriber which is currently busy (486 response from the UAS)	The number you are trying to reach is currently busy. Please try again later.
callee_offline	Announcement played on incoming call to the subscriber which is currently not registered	The number you are trying to reach is currently not available. Please try again later.

Table 5: (continued)

Handle	Description	Message played
<code>callee_tmp_unavailable</code>	Announcement played on incoming call to the subscriber which is currently unavailable (408, other 4xx or no response code or 30x with malformed contact)	The number you are trying to reach is currently not available. Please try again later.
<code>callee_unknown</code>	Announcement that is played on call to unknown or invalid number (not associated with any of our subscribers/hunt groups)	The number you are trying to reach is not in use.
<code>cf_loop</code>	Announcement played when the called subscriber has the call forwarding configured to itself	The number you are trying to reach is forwarded to an invalid destination.
<code>emergency_geo_unavailable</code>	Announcement played when emergency destination is dialed but the destination is not provisioned for the location of the user. <i>PLEASE NOTE:</i> The configuration entry for this case in <code>/etc/ngcp-config/config.yml</code> file is <code>emergency_invalid</code> .	The emergency number you have dialed is not available in your region.
<code>emergency_unsupported</code>	Announcement played when emergency destination is dialed but the emergency calls are administratively prohibited for this user or domain (<i>reject_emergency</i> preference is enabled)	You are not allowed to place emergency calls from this line. Please use a different phone.
<code>error_please_try_later</code>	Announcement played when the call is handled by 3rd party call control (PCC) and there was an error during call processing. <i>PLEASE NOTE:</i> This announcement may be configured in the sound set in <code>voucher_recharge</code> section.	An error has occurred. Please try again later.
<code>invalid_speeddial</code>	This is what the calling party hears when it calls an empty speed-dial slot	The speed dial slot you are trying to use is not available.
<code>locked_in</code>	Announcement played on incoming call to a subscriber that is locked for incoming calls	The number you are trying to reach is currently not permitted to receive calls.
<code>locked_out</code>	Announcement played on outgoing call to subscriber that is locked for outgoing calls	You are currently not allowed to place outbound calls.

Table 5: (continued)

Handle	Description	Message played
max_calls_in	Announcement played on incoming call to a subscriber who has exceeded the <i>concurrent_max</i> limit by sum of incoming and outgoing calls or whose customer has exceeded the <i>concurrent_max_per_account</i> limit by sum of incoming and outgoing calls	The number you are trying to reach is currently busy. Please try again later.
max_calls_out	Announcement played on outgoing call to a subscriber who has exceeded the <i>concurrent_max</i> (total limit) or <i>concurrent_max_out</i> (limit on number of outbound calls) or whose customer has exceeded the <i>concurrent_max_per_account</i> or <i>concurrent_max_out_per_account</i> limit	All outgoing lines are currently in use. Please try again later.
max_calls_peer	Announcement played on calls from the peering if that peer has reached the maximum number of concurrent calls (configured by admin in <i>concurrent_max</i> preference of peering server). <i>PLEASE NOTE</i> : There is no configuration option of the status code and text in <i>config.yml</i> file for this case.	The network you are trying to reach is currently busy. Please try again later.
no_credit	Announcement played when prepaid account has insufficient balance to make a call to this destination	You don't have sufficient credit balance for the number you are trying to reach.
peering_unavailable	Announcement played in case of outgoing off-net call when there is no peering rule matching this destination and/or source	The network you are trying to reach is not available.
reject_vsc	When the VSC (Vertical Service Code) service is disabled in domain or subscriber preferences (Access Restrictions / <i>reject_vsc</i> is set to TRUE) and a subscriber tries to make a call with VSC, an announcement is played.	N/A (custom message, no default)
relaying_denied	Announcement played on inbound call from trusted IP (e.g. external PBX) with non-local Request-URI domain	The network you are trying to reach is not available.
unauth_caller_ip	This is what the calling party hears when it tries to make a call from unauthorized IP address or network (<i>allowed_ips</i> , <i>man_allowed_ips</i> preferences)	You are not allowed to place calls from your current network location.

Table 5: (continued)

Handle	Description	Message played
voicebox_unavailable	<i>PLEASE NOTE:</i> This announcement is already obsolete, as of Sipwise C5 version mr5.3	The voicemail of the number you are trying to reach is currently not available. Please try again later.

There are some early reject scenarios when either **no voice announcement is played, or a fixed announcement is played**. In either case a SIP error status message is sent from Sipwise C5 to the calling party. It is possible to configure the exact status code and text for such cases in the `/etc/ngcp-config/config.yml` file, in `kamailio.proxy.early_rejects` section. The below table gives an overview of those early reject cases.

Table 6: Additional Early Reject Reason Codes

Handle	Description
block_admin	Caller blocked by <code>adm_block_in_list</code> , <code>adm_block_in_clir</code> and callee blocked by <code>adm_block_out_list</code> (customer or subscriber preference)
block_callee	Callee blocked by subscriber preference <code>block_out_list</code>
block_caller	Caller blocked by subscriber preference <code>block_in_list</code> , <code>block_in_clir</code>
block_contract	Caller blocked by customer preference <code>block_in_list</code> , <code>block_in_clir</code> and callee blocked by customer preference <code>block_out_list</code>
callee_tmp_unavailable_gp	Callee is a PBX group with 0 members. Announcement <code>callee_tmp_unavailable</code> is played; status code and text can be configured.
callee_tmp_unavailable_tm	Callee is a PBX group and we have a timeout (i.e. no group member could be reached). Announcement <code>callee_tmp_unavailable</code> is played; status code and text can be configured.
emergency_invalid	<i>PLEASE NOTE:</i> This handle refers to the same early reject case as <code>emergency_geo_unavailable</code> , but is labeled differently in the configuration file.

7.14.3 Play an announcement on behalf of callee server failure in case of outbound calls

The Sipwise C5 makes it possible to play an announcement on behalf of callee server failure in case of outbound calls. The features can be activated on Subscribers and on Peers. For example: if subscriber A calls subscriber B and B refuses the call with code 404 without providing any announcement, Sipwise C5 can be configured to play a customized announcement to A on behalf of B.

To activate this feature, first create a system *Sound Set*, or use an already existing one, and then assign it to the callee subscriber. Upload in the *Sound Set* one or more announcements. Once the *Sound Set* is configured, the subscriber's preference *announce_error_codes_enable* must be enabled under *Subscriber* → *Preferences* → *NAT and Media Flow Control* menu. Last step is to list in the subscriber's preference *announce_error_codes_list* the announcements that will be played to the caller in case a particular error code is returned back from the callee. Each entry of the list has to be a string composed in the following way: `<error_code>;<announcement_name>`, where *error_code* is the SIP return code and *announcement_name* is name of the announcement taken from the *sound_set* list. Returning to the example above, to play *callee_unknown* message in case of 404 returned from the callee, the entry `404;callee_unknown` has to be added in *announce_error_codes_list* preference.

The same feature is available for peer as well.



Important

In case *announce_error_codes_enable* is enabled, it is important that the remote endpoint doesn't play any announcement for error codes listed in *announce_error_codes_list* otherwise the final result will be to have two announcements: one generated by the remote endpoint and one generated by Sipwise C5.

7.15 Conference System

The Sipwise C5 provides the simple pin-protected conferencing service built using the SEMS DSM scripting language. Hence it is open for all kinds of modifications and extensions.

Template files for the sems conference scripts stored in `/etc/ngcp-config/templates/etc/ngcp-sems/`:

- IVR script: `/etc/ngcp-config/templates/etc/ngcp-sems/dsm/confpin.dsm.tt2`
- Config: `/etc/ngcp-config/templates/etc/ngcp-sems/dsm/confpin.conf.tt2`

7.15.1 Configuring Call Forward to Conference

Go to your *Subscriber Preferences* and click *Edit* on the Call Forward Type you want to set (e.g. *Call Forward Unconditional*).

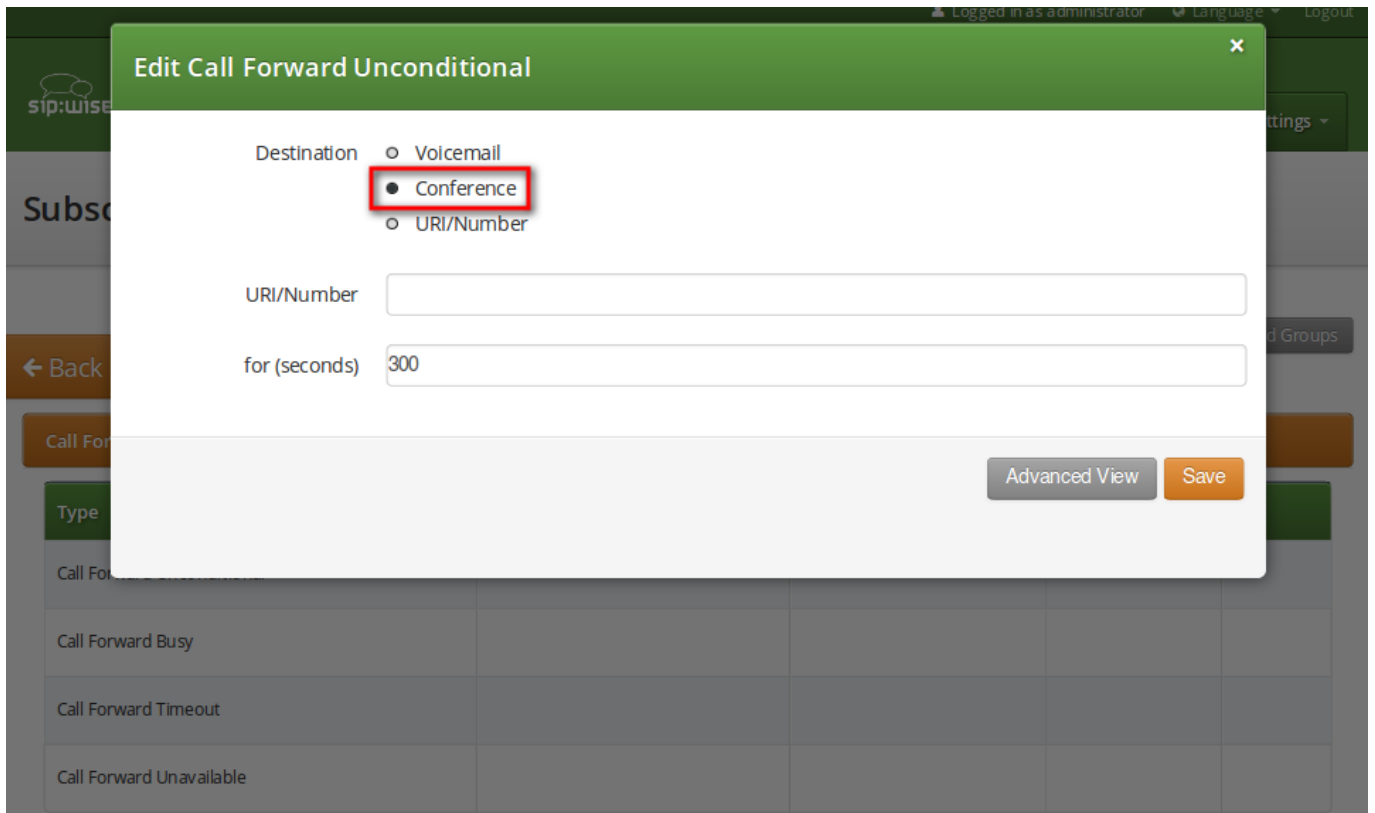

Destination Voicemail Conference URI/Number

URI/Number

for (seconds)

Advanced View Save

You should select *Conference* option in the *Destination* field and leave the *URI/Number* empty. The timeout defines for how long this destination should be tried to ring.

7.15.2 Configuring Conference Sound Sets

Sound Sets can be defined in *Settings*→*Sound Sets*. To create a new Sound Set, click *Create Sound Set*. Then click the *Files* button.

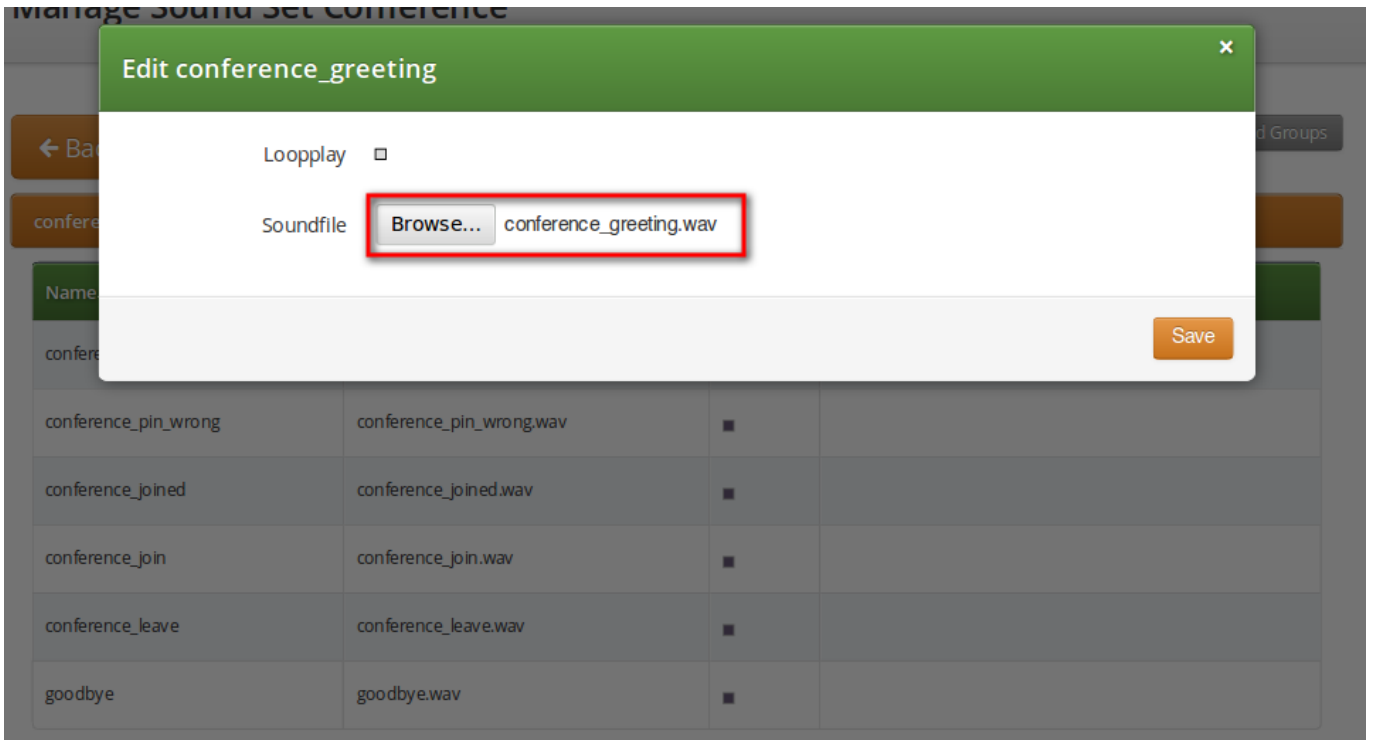

Upload the following files:

Table 7: Conference Sound Sets

Handle	Message played
conference_greeting	Welcome to the conferencing service.
conference_pin	Please enter your PIN, followed by the pound key.
conference_pin_wrong	You have entered an invalid PIN number. Please try again.
conference_joined	You will be placed into the conference.
conference_first	You are the first person in the conference.
conference_join	A person has joined the conference.
conference_leave	A person has left the conference.
conference_max_participants	All conference lines are currently in use. Please try again later.
conference_waiting_music	... waiting music...
goodbye	Goodbye.

Note

You may use 8 or 16 bit mono WAV audio files.

Then set the preference *sound_set* on the Domain or Subscriber level in order to assign the Sound Set you have just created to the subscriber (as usual the subscriber preference overrides the domain one).

7.15.3 Joining the Conference

There are 2 ways of joining a conference: with or without PIN code. The actual way of joining the conference depends on *Subscriber* settings. A subscriber who has activated the conference through call forwarding may set a PIN in order to protect the conference from unauthorized access. To activate the PIN one has to enter a value in *Subscriber* → *Details* → *Preferences* → *Internals* → *conference_pin* field.

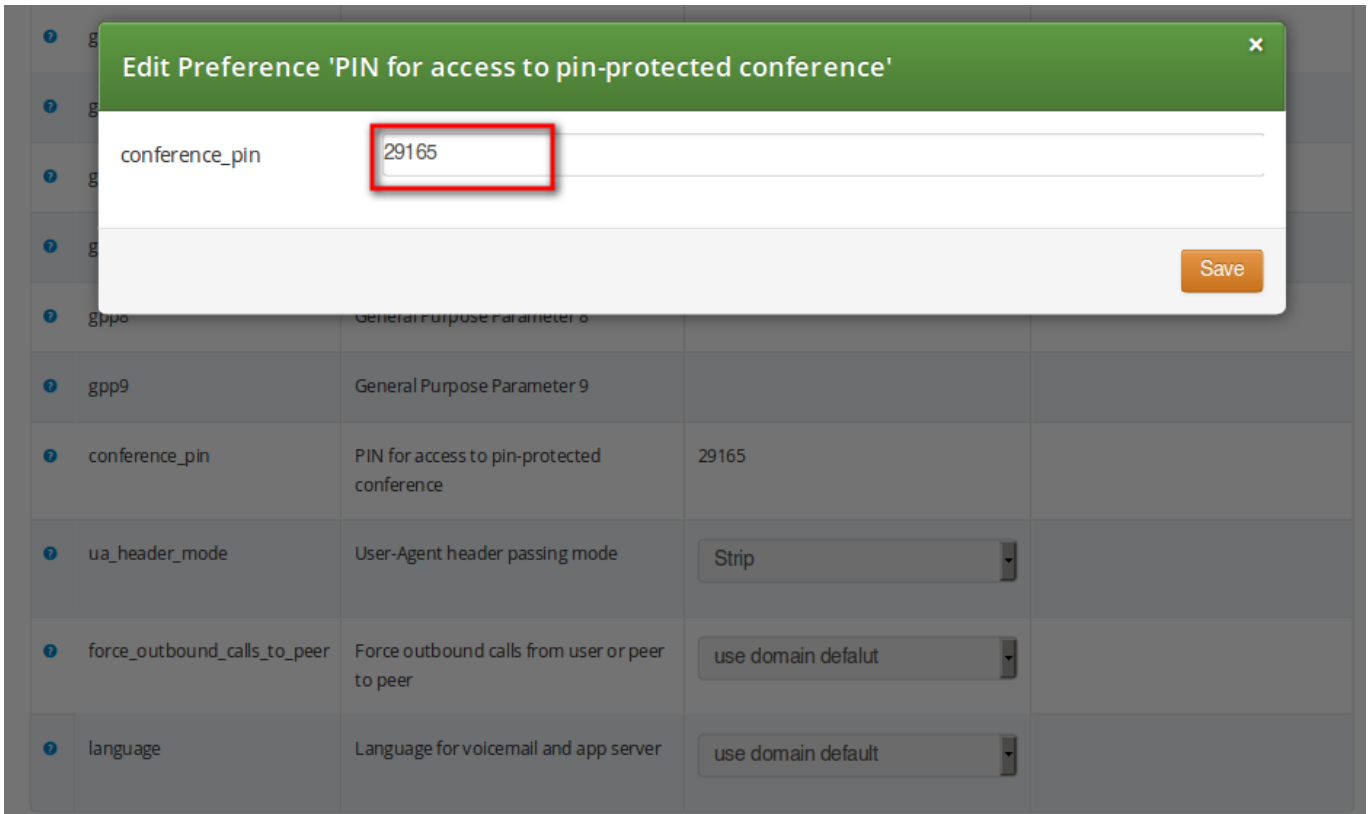

Figure 58: Setting Conference PIN

In case the PIN protection for the conference is activated, when someone calls the subscriber who has enabled the conference, the caller is prompted to enter the PIN of the conference. Upon the successful entry of the PIN the caller hears the announcement that he is going to be placed into the conference and at the same time this is announced to all participants already in the conference.

7.15.4 Conference Flowchart with Voice Prompts

The following 2 sections show flowcharts with voice prompts that are played to a caller when he dials the conference.

7.15.4.1 Conference Flowchart with PIN Validation

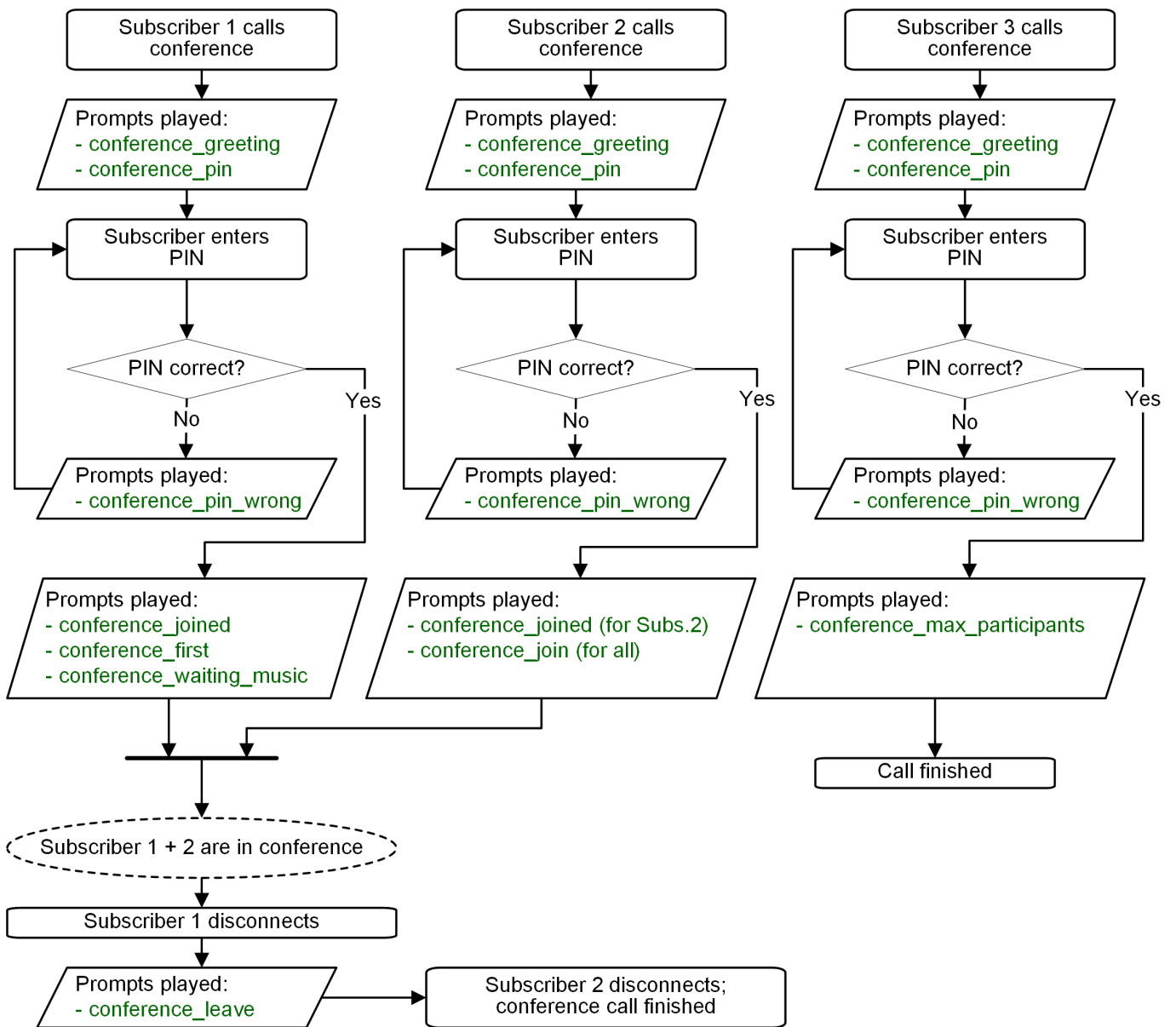

Figure 59: Flowchart of Conference with PIN Validation

7.15.4.2 Conference Flowchart without PIN

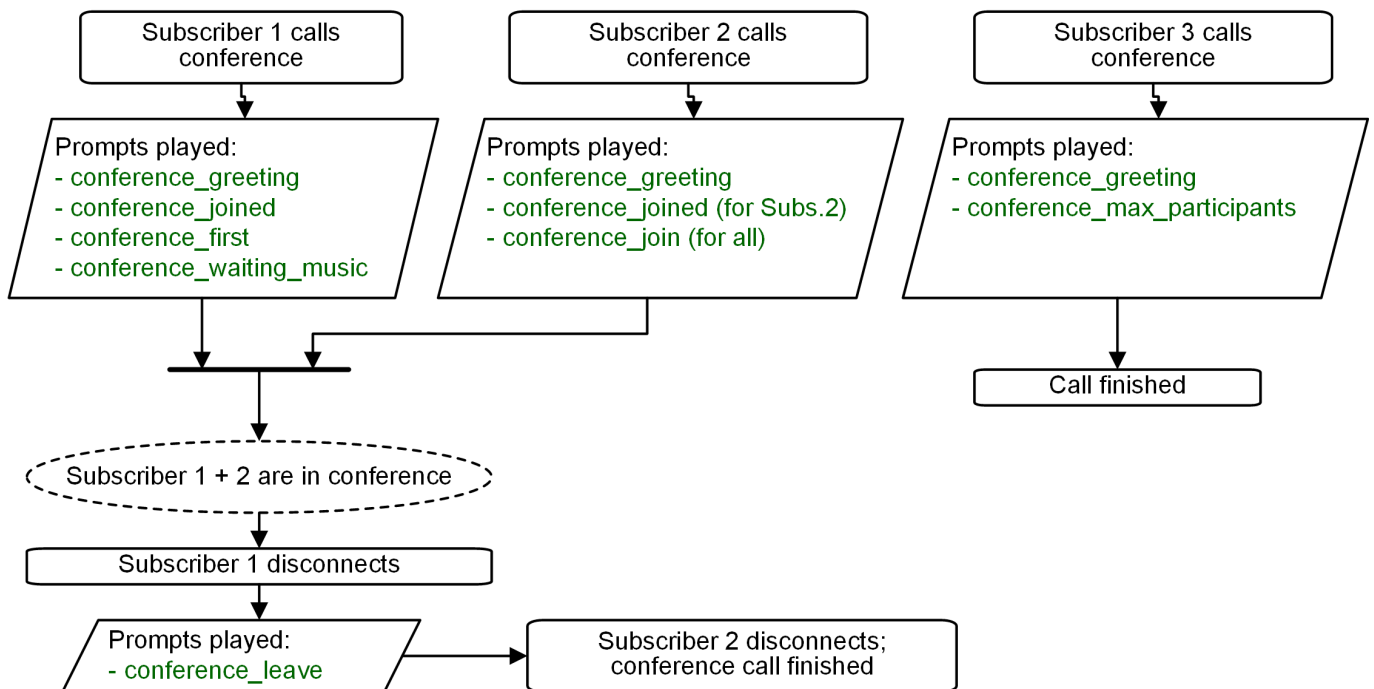

Figure 60: Flowchart of Conference without PIN

7.16 Malicious Call Identification (MCID)

MCID feature allows customers to report unwanted calls to the platform operator.

7.16.1 Setup

To enable the feature first edit `config.yml` and enable there `apps: malicious_call: yes` and `kamailio: store_recent_calls: yes`. The latter option enables kamailio to store recent calls per subscriber UUID in the redis DB (the amount of stored recent calls will not exceed the amount of provisioned subscribers).

Next step is to create a system sound set for the feature. In *Settings* → *Sound Sets* either use your already existing *Sound Set* or create a new *Sound Set* and then assign it to your domain or subscribers. In the *Sound Set* there is a fileset *malicious_call_identification* → for that purpose.

Once the *Sound Set* is created the Subscriber's Preferences *Malicious Call Identification* must be enabled under *Subscriber* → *Preferences* → *Applications* menu. The same parameter can be set in the Customer's preferences to enable this feature for all its subscribers.

The final step is to create a new *Rewrite Rule* and to route calls to, for instance `*123` → MCID application. For that you create a *Callee Inbound* rewrite rule `^(*123)$ → malicious_call`

Finally you run `ngcpcfg apply "Enabling MCID"` to recreate the templates and automatically restart depended services.

7.16.2 Usage

As a subscriber, to report a malicious call you call to either *malicious_call* or to your custom number assigned for that purpose. Please note that you can report only your last received call. You will hear the media reply from the *Sound Set* you have previously configured.

To check reported malicious calls as the platform operator open *Settings*→*Malicious Calls* tab where you will see a list of registered calls. You can selectively delete records from the list and alternatively you can manage the reported calls by using the REST API.

7.16.3 Advanced configuration

By default the expiration time for the most recent call per subscriber is 3600 seconds (1 hour). If you wish to prolong or shorten the expiration time open `constants.yml` and set there `recentcalls: expire: 3600` to a new value, and issue `ngcpcfg apply "Enabling MCID" afterwards`.

7.17 Subscriber Profiles

The preferences a subscriber can provision by himself via the CSC can be limited via profiles within profile sets assigned to subscribers.

7.17.1 Subscriber Profile Sets

Profile sets define containers for profiles. The idea is to define profile sets with different profiles by the administrator (or the reseller, if he is permitted to do so). Then, a subscriber with administrative privileges can re-assign profiles within his profile sets for the subscribers of his customer account.

Profile Sets can be defined in *Settings*→*Subscriber Profiles*. To create a new Profile Set, click *Create Subscriber Profile Set*.

The screenshot shows the Sipwise NGCP Dashboard with a modal window titled "Create Subscriber Profile Sets". The modal contains a "Reseller" section with a search bar and a table of resellers. The table has columns for "#", "Name", "Contract #", "Status", and a checkbox. Below the table, it says "Showing 1 to 2 of 2 entries" and includes navigation buttons. There is a "Create Reseller" button. Below the table, there are input fields for "Name" (containing "testset") and "Description" (containing "Test Set"). A "Save" button is at the bottom right of the modal.

#	Name	Contract #	Status	
1	default	1	active	<input checked="" type="checkbox"/>
2	test	2	active	<input type="checkbox"/>

You need to provide a reseller, name and description.

To create Profiles within a Profile Set, hover over the Profile Set and click the *Profiles* button.

Profiles within a Profile Set can be created by clicking the *Create Subscriber Profile* button.

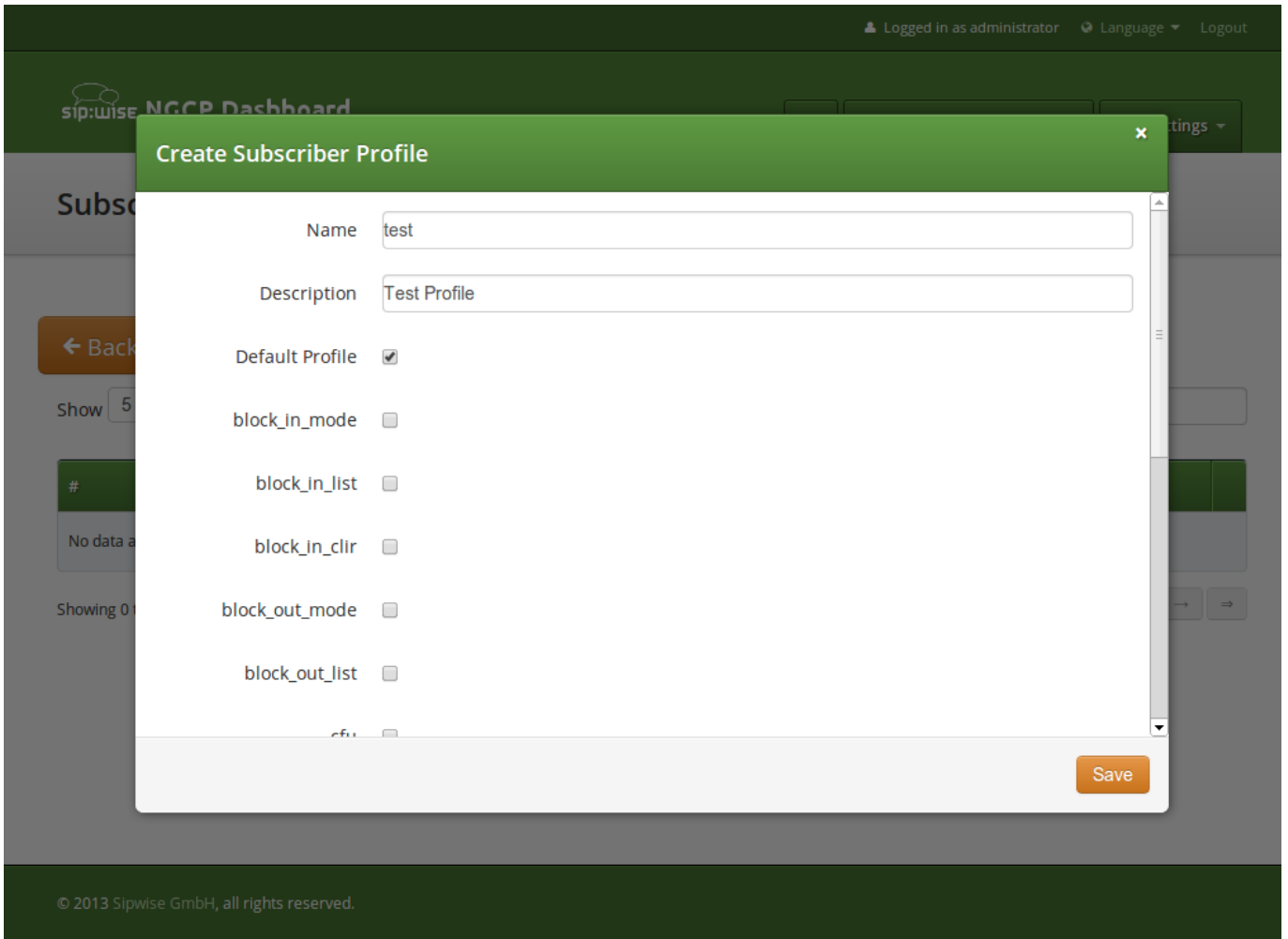

Checking the *Default Profile* option causes this profile to get assigned automatically to all subscribers, who have the profile set assigned. Other options define the user preferences which should be made available to the subscriber.

Note

When the platform administrator selects *Preferences* of the Subscriber Profile he will get an empty page like in the picture below, if none or only certain options are selected in the Subscriber Profile.

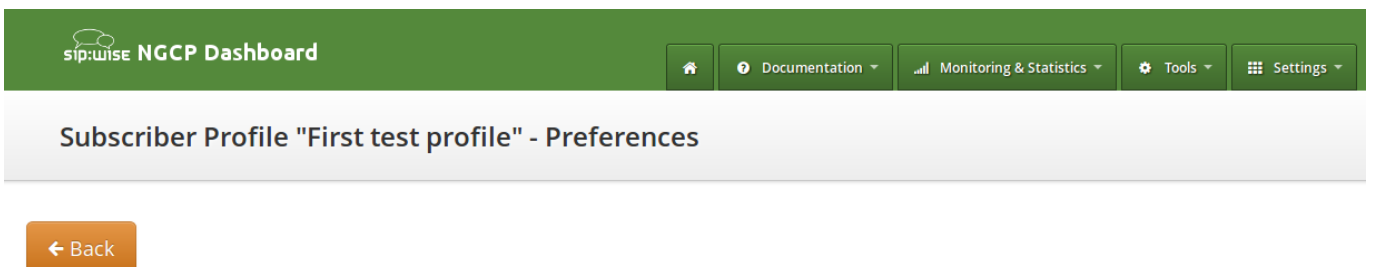

Some of the options, like `ncos` (NCOS level), will enable the definition of that preference within the Subscriber Profile Preferences. Thus all subscribers who have this profile assigned to will have the preference activated by default. The below picture shows the preferences linked to the sample Subscriber Profile:

sip:wise NGCP Dashboard

Home Documentation Monitoring & Statistics Tools Settings

Subscriber Profile "Test profile 1 for NCOS" - Preferences

Back Expand Groups

Call Blockings

	Attribute	Name	Value
	ncos	NCOS Level	Test NCOS for blocking outca

7.18 SIP Loop Detection

In order to detect a SIP loop (incoming call as a response for a call request) Sipwise C5 checks the combination of *SIP-URI*, *To* and *From* headers.

This check can be enabled in config.yml by setting `kamailio.proxy.loop_detection.enable: yes`. The system tolerates `kamailio.proxy.loop_detection.expire` seconds. Higher occurrence of loops will be reported with a SIP 482 "Loop Detected" error message

7.19 Invoices and Invoice Templates

Content and vision of the invoices are customizable by [invoice templates](#).

Note

The Sipwise C5 generates invoices in pdf format.

7.19.1 Invoices Management

Invoices can be requested for generation, searched, downloaded and deleted on the administrative web interface. Navigate to *Settings* → *Invoices* menu and you get a list of all invoices currently stored in the database.

Tip

The system operator or a third party application can also generate, list, retrieve and delete invoices via the REST API. Please read further details [here](#).

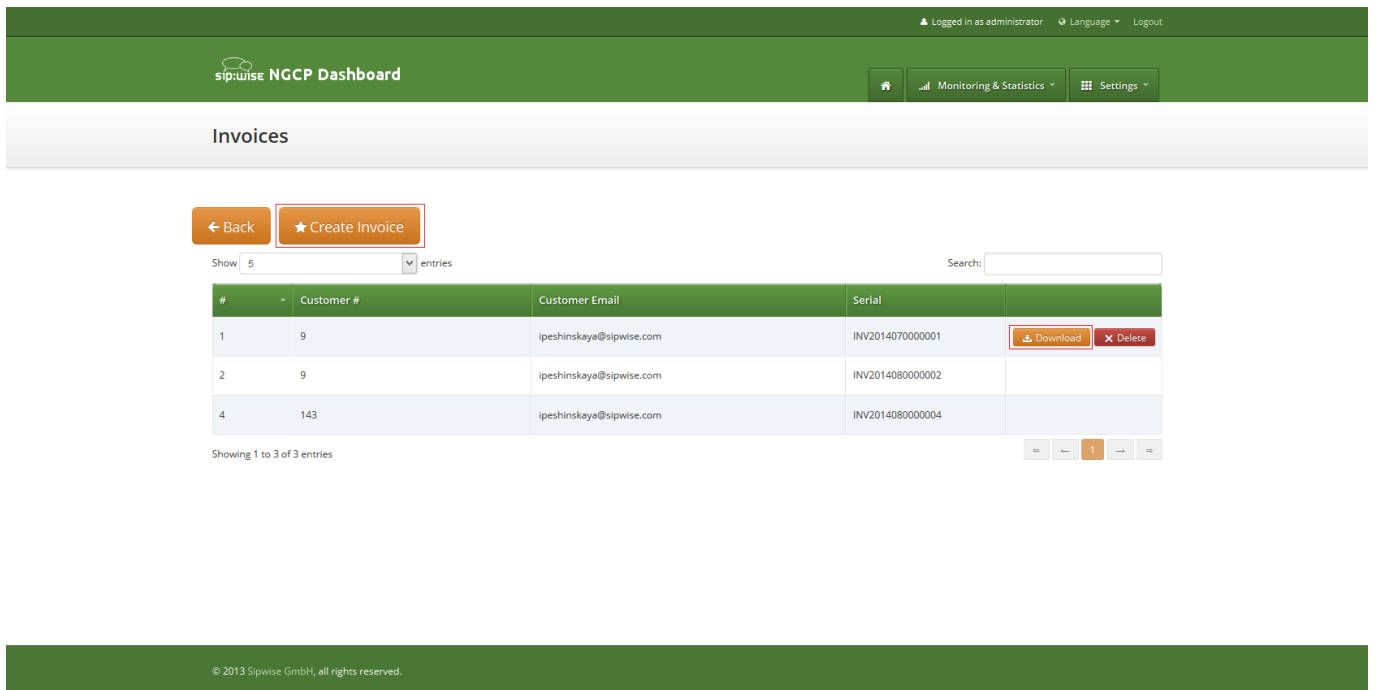

Logged in as administrator | Language | Logout

sipwise NGCP Dashboard

Monitoring & Statistics | Settings

Invoices

← Back | ★ Create Invoice

Show 5 entries | Search:

#	Customer #	Customer Email	Serial	
1	9	ipeshinskaya@sipwise.com	INV2014070000001	Download Delete
2	9	ipeshinskaya@sipwise.com	INV2014080000002	
4	143	ipeshinskaya@sipwise.com	INV2014080000004	

Showing 1 to 3 of 3 entries

© 2013 Sipwise GmbH, all rights reserved.

To request invoice generation for the particular customer and period press "Create invoice" button. On the invoice creation form following parameters are available for selection:

- **Template:** any of existent invoice template can be selected for the invoice generation.
- **Customer:** owner of the billing account, recipient of the invoice.
- **Invoice period:** billing period. Can be specified only as one calendar month. Calls with start time between first and last second of the period will be considered for the invoice

All form fields are mandatory.

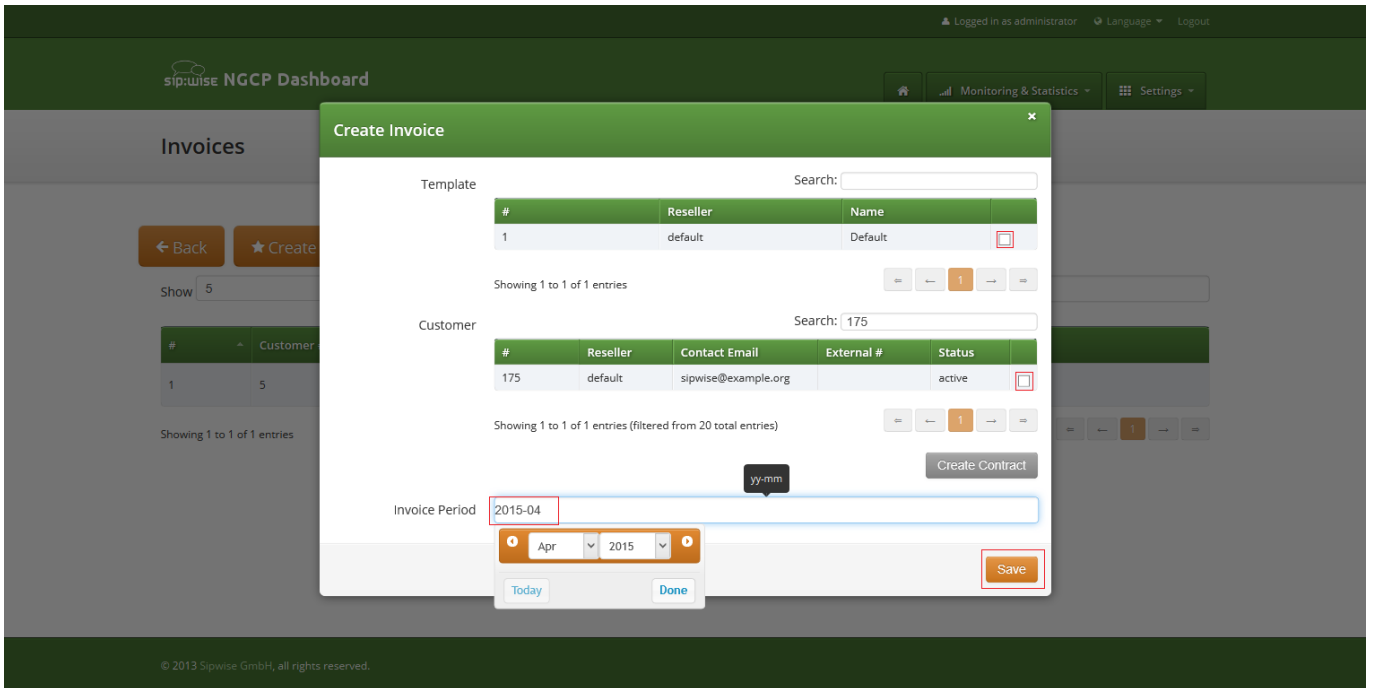

Generated invoice can be downloaded as pdf file.

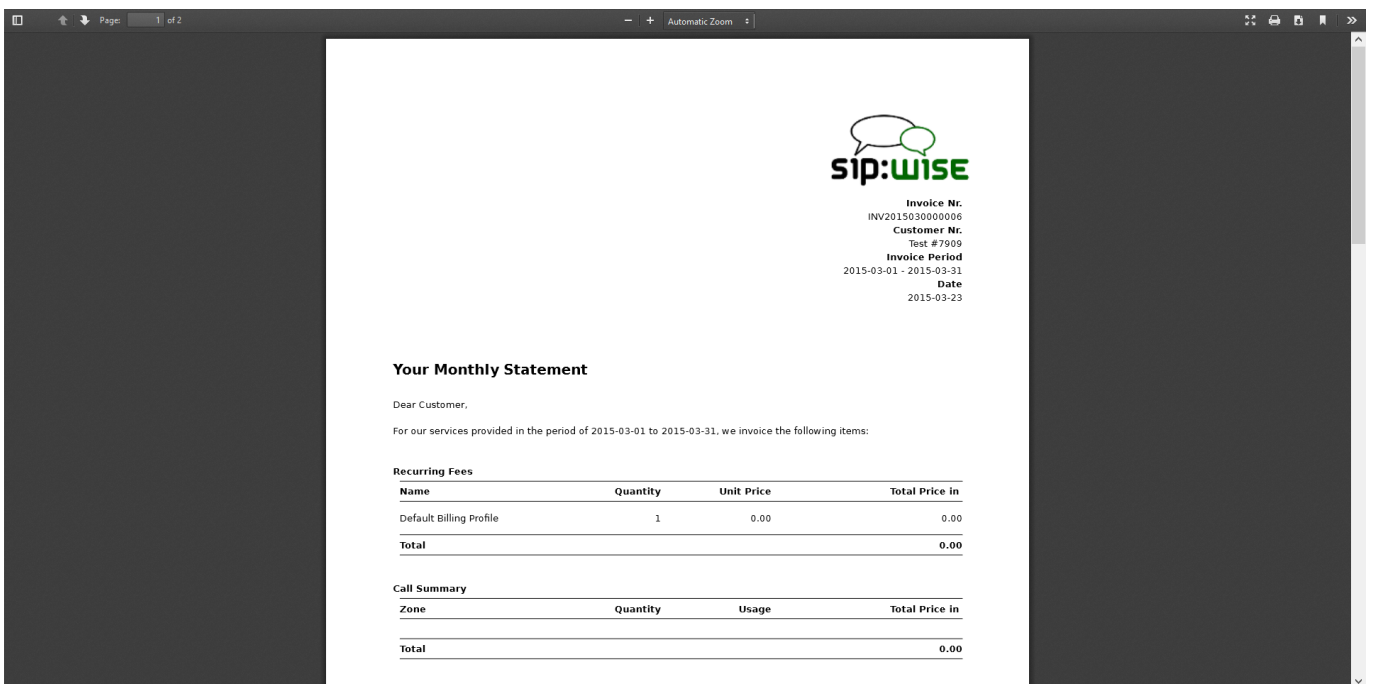

To do it press button "Download" against invoice in the invoice management interface.

Respectively press on the button "Delete" to delete invoice.

7.19.2 Invoice Management via REST API

Besides managing invoices on the admin web interface of NGCP, the system administrator (or a third party system) has the opportunity to request generation and retrieval of invoices via the *REST API*.

The subsequent sections describe the available operations for invoice management with API requests in details. All operations work on the *Invoices* resource and use the `/api/invoices` base path. The authentication method is username/password in the examples given below, however it is recommended to use a TLS client certificate for authentication on the REST API.

Note

The full API documentation is always available at the location: `https://<IP_of_NGCP_web_panel>:1443/api`

7.19.2.1 Generate a New Invoice

The **prerequisite** for generating a new invoice is that the customer has to have **an invoice template** assigned to him.

The following example shows a CURL command that will request generation of an invoice:

- for customer with ID "79"
- for the time period of November 2017
- based on the invoice template with ID "1"

```
curl -i -X POST -H 'Connection: close' -H 'Content-Type: application/json' \
--user adminuser:adminpwd -k 'https://127.0.0.1:1443/api/invoices/' \
--data-binary '{ "customer_id" : "79", "template_id" : "1", \
"period_start": "2017-11-01 00:00:00", "period_end": "2017-11-30 23:59:59" }'
```

Please note that in this operation we used the `/api/invoices` path (the *invoices* collection) and a *POST* request on it to create a new invoice item.

In case of a **successful operation**, Sipwise C5 will reply with **201 Created** HTTP status and send the ID of the invoice in *Location* header. In our example the new invoice item may be directly referred as `/api/invoices/3` (ID = 3).

```
HTTP/1.1 201 Created
Server: nginx
Date: Tue, 14 Nov 2017 13:38:40 GMT
Content-Length: 0
Connection: close
Location: /api/invoices/3
Set-Cookie: ngcp_panel_session=d5e4a8dd003fd7cac646653a6b5aefa703cf3e66; path=/; expires= ↵
Tue, 14-Nov-2017 14:38:38 GMT; HttpOnly
X-Catalyst: 5.90114
Strict-Transport-Security: max-age=15768000
```

In case of a **failed operation**, e.g. when we request an invoicing period that is invalid for the customer, Sipwise C5 will reply with **422 Unprocessable Entity** or **500 Internal Server Error** HTTP status.

7.19.2.2 Download Invoice Data

You can download properties / data of a specific invoice by selecting the item by its ID, using an HTTP *GET* request.

```
curl -i -X GET -H 'Connection: close' --user adminuser:adminpwd -k \  
'https://127.0.0.1:1443/api/invoices/3'
```

The above request will return a JSON data structure containing invoice properties:

```
HTTP/1.1 200 OK  
Server: nginx  
Date: Wed, 15 Nov 2017 12:13:04 GMT  
Content-Type: application/hal+json; profile="http://purl.org/sipwise/ngcp-api/"; charset= ↵  
utf-8  
Content-Length: 759  
Connection: close  
Link: </api/invoices/>; rel=collection  
Link: <http://purl.org/sipwise/ngcp-api/>; rel=profile  
Link: </api/invoices/3>; rel="item self"  
Link: </api/invoices/3>; rel="item http://purl.org/sipwise/ngcp-api/#rel-invoices"  
Link: </api/customers/79>; rel="item http://purl.org/sipwise/ngcp-api/#rel-customers"  
Set-Cookie: ngcp_panel_session=219fecbbe4fa936defd1ee511c84efe7b5a6d6a; path=/; expires= ↵  
Wed, 15-Nov-2017 13:13:03 GMT; HttpOnly  
Strict-Transport-Security: max-age=15768000  
  
{  
  "_links" : {  
    "collection" : {  
      "href" : "/api/invoices/"  
    },  
    "curies" : {  
      "href" : "http://purl.org/sipwise/ngcp-api/#rel-{rel}",  
      "name" : "ngcp",  
      "templated" : true  
    },  
    "ngcp:customers" : {  
      "href" : "/api/customers/79"  
    },  
    "ngcp:invoices" : {  
      "href" : "/api/invoices/3"  
    },  
    "profile" : {  
      "href" : "http://purl.org/sipwise/ngcp-api/"  
    },  
    "self" : {
```

```

    "href" : "/api/invoices/3"
  }
},
"amount_net" : 0,
"amount_total" : 0,
"amount_vat" : 0,
"id" : 3,
"period_end" : "2017-11-30T23:59:59+00:00",
"period_start" : "2017-11-01T00:00:00+00:00",
"sent_date" : null,
"serial" : "INV2017110000003"
}

```

It is also possible to query the complete *invoices* collection and use a filter (e.g. invoicing period, customer ID, etc.) to get the desired invoice item. In the example below we request all available invoices that belong to the customer with ID "79".

```

curl -i -X GET -H 'Connection: close' --user adminuser:adminpwd -k \
'https://127.0.0.1:1443/api/invoices/?customer_id=79'

```

The returned dataset is now slightly different because it is represented as an array of items, although in our example the array consist of only 1 item:

```

{
  "_embedded" : {
    "ngcp:invoices" : [
      {
        "_links" : {
          "collection" : {
            "href" : "/api/invoices/"
          },
          "curies" : {
            "href" : "http://purl.org/sipwise/ngcp-api/#rel-{rel}",
            "name" : "ngcp",
            "templated" : true
          },
          "ngcp:customers" : {
            "href" : "/api/customers/79"
          },
          "ngcp:invoices" : {
            "href" : "/api/invoices/3"
          },
          "profile" : {
            "href" : "http://purl.org/sipwise/ngcp-api/"
          },
          "self" : {

```

```

        "href" : "/api/invoices/3"
      }
    },
    "amount_net" : 0,
    "amount_total" : 0,
    "amount_vat" : 0,
    "id" : 3,
    "period_end" : "2017-11-30T23:59:59+00:00",
    "period_start" : "2017-11-01T00:00:00+00:00",
    "sent_date" : null,
    "serial" : "INV2017110000003"
  }
]
},
"_links" : {
  "curies" : {
    "href" : "http://purl.org/sipwise/ngcp-api/#rel-{rel}",
    "name" : "ngcp",
    "templated" : true
  },
  "ngcp:invoices" : {
    "href" : "/api/invoices/3"
  },
  "profile" : {
    "href" : "http://purl.org/sipwise/ngcp-api/"
  },
  "self" : {
    "href" : "/api/invoices/?page=1&rows=10"
  }
},
"total_count" : 1
}

```

7.19.2.3 Download Invoice as PDF File

You can download a specific invoice as a PDF file in the following way:

- selecting the item by its ID (as in our example, but you can also use a filter and query the complete *invoices* collection)
- using an HTTP *GET* request
- adding "**Accept: application/pdf**" header to the request

```

curl -X GET -H 'Connection: close' -H 'Accept: application/pdf' \
  --user adminuser:adminpwd -k 'https://127.0.0.1:1443/api/invoices/3' > result.pdf

```

Please note that in the example above we **do not add the "-i" option** that would also include the headers of the HTTP response in the output file. The output of the CURL command, i.e. the PDF file, is saved as "result.pdf" locally.

7.19.2.4 Delete an Invoice

In order to delete an invoice item you have to send a *DELETE* request on the specific item:

```
curl -i -X DELETE -H 'Connection: close' --user adminuser:adminpwd -k \
'https://127.0.0.1:1443/api/invoices/3'
```

In case of successful deletion Sipwise C5 should send HTTP status 204 No Content as a response:

```
HTTP/1.1 204 No Content
Server: nginx
Date: Wed, 15 Nov 2017 13:42:42 GMT
Connection: close
Set-Cookie: ngcp_panel_session=10b66a6baf25a09739c2bb2377c70eccee78387; path=/; expires= ↵
Wed, 15-Nov-2017 14:42:42 GMT; HttpOnly
X-Catalyst: 5.90114
Strict-Transport-Security: max-age=15768000
```

7.19.3 Invoice Templates

Invoice template defines structure and look of the generated invoices. The Sipwise C5 makes it possible to create some invoice templates. Multiple invoice templates can be used to send invoices to the different customers using different languages.



Important

At least one invoice template should be created to enable invoice generation. Each customer has to be associated to one of the existent invoice template, otherwise invoices will be not generated for this customer.

Customer can be linked to the invoice template in the customer interface.

7.19.3.1 Invoice Templates Management

Invoice templates can be searched, created, edited and deleted in the invoice templates management interface.

Logged in as administrator | Language | Logout

sip:wise NGCP Dashboard | Home | Monitoring & Statistics | Settings

Invoice Templates

← Back | ★ Create Invoice Template

Search:

#	Reseller	Name	Type	
1	default	Default	svg	Edit Meta Edit Content Delete

Showing 1 to 1 of 1 entries

© 2013 Sipwise GmbH, all rights reserved.

Invoice template creation is separated on two steps:

- Register new invoice template meta information.
- Edit content (template itself) of the invoice template.

To register new invoice template press "Create Invoice Template" button.

On the invoice template meta information form following parameters can be specified:

- **Reseller:** reseller who owns this invoice template. Please note, that it doesn't mean that the template will be used for the reseller customers by default. After creation, invoice template still need to be linked to the reseller customers.
- **Name:** unique invoice template name to differentiate invoice templates if there are some.
- **Type:** currently Sipwise C5 supports only svg format of the invoice templates.

All form fields are mandatory.

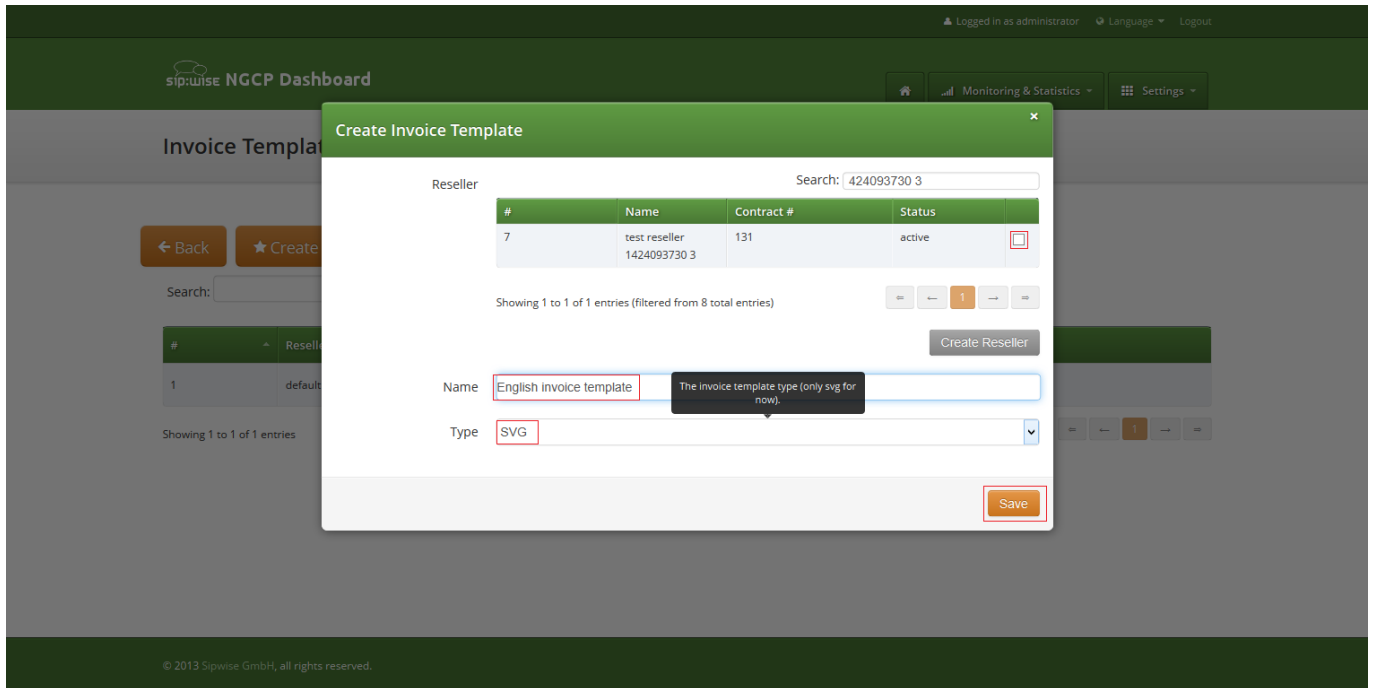

After registering new invoice template you can change invoice template structure in WYSIWYG SVG editor and preview result of the invoice generation based on the template.

7.19.3.2 Invoice Template Content

Invoice template is a XML SVG source, which describes content, look and position of the text lines, images or other invoice template elements. The Sipwise C5 provides embedded WYSIWYG SVG editor `svg-edit 2.6` to customize default template. The Sipwise C5 `svg-edit` has some changes in layers management, image edit, user interface, but this [basic introduction](#) still may be useful.

Template refers to the owner reseller contact ("rescontact"), customer contract ("customer"), customer contact ("custcontact"), billing profile ("billprof"), invoice ("invoice") data as variables in the "[%%]" mark-up with detailed information accessed as field name after point e.g. [%invoice.serial%]. During invoice generation all variables or other special tokens in the "[% %]" mark-ups will be replaced by their database values.

Press on "Show variables" button on invoice template content page to see full list of variables with the fields:

The screenshot displays the 'Invoice template TestInvoice' editor in the Sipwise NGCP Dashboard. On the left, a 'Template variables' panel lists various variables such as `rescontact.bankname`, `rescontact.bic`, `rescontact.city`, `rescontact.company`, `rescontact.comregnum`, `rescontact.country`, `rescontact.faxnumber`, `rescontact.firstname`, `rescontact.gender`, `rescontact.gpp0`, `rescontact.gpp1`, `rescontact.gpp2`, `rescontact.gpp3`, `rescontact.gpp4`, `rescontact.gpp5`, `rescontact.gpp6`, `rescontact.gpp7`, `rescontact.gpp8`, `rescontact.gpp9`, and `rescontact.iban`. The main editor window shows a preview of an invoice template with embedded variables like `[% custcontact.firstname %] [% custcontact.lastname %]`, `[% custcontact.street %]`, `[% custcontact.postcode %] [% custcontact.city %]`, `[% custcontact.country %]`, `[% invoice.serial %]`, `[% customerexternal_id %]`, `[% p_start %] [% p_end %]`, and `[% date_now(format='%Y-%m-%d') %]`. The preview text includes 'Your Monthly Statement' and 'Dear Customer,'.

You can add/change/remove embedded variables references directly in main svg-edit window. To edit text line in svg-edit main window double click on the text and place cursor on desired position in the text.

After implementation of the desired template changes, invoice template should be [saved](#).

To return to Sipwise C5 invoice template **default** content you can press on the "Discard changes" button.



Important

"Discard changes" operation can't be undone.

Layers

Default template contains three groups elements (`<g/>`), which can be thought of as pages, or in terms of svg-edit - layers. Layers are:

- **Background:** special layer, which will be repeated as background for every other page of the invoice.
- **Summary:** page with a invoice summary.
- **CallList:** page with calls made in a invoice period. Is invisible by default.

To see all invoice template layers, press on "Layers" vertical sign on right side of the svg-edit interface:

Logged in as administrator Language Logout
sipwise NGCP Dashboard Monitoring & Statistics Settings
Invoice template TestInvoice

← Back Save SVG Preview PDF Discard Changes Show Variables

Invoice Nr. [% invoice.serial %]
Customer Nr. [% customer.external_id %]
Invoice Period [% p_start %] - [% p_end %]
Date [% date_now(format="%Y-%m-%d") %]

Your Monthly Statement
 Dear Customer,
 For our services provided in the period of [% p_start %] to [% p_end %], we invoice the following items:

Recurring Fees			
Name	Quantity	Unit Price	Total Price in [% cur %]
[% billprof.name %]	1	[% fixfee %]	[% fixfee %]
Total			[% fixfee %]

Call Summary			
Zone	Quantity	Usage	Total Price in [% cur %]
Total			[% zonefee %]

Summary		in [% cur %]
Total Summary		[% netfee %]
VAT [% customer.vat_rate %]%		[% vatfee %]
Amount Due		[% allfee %]

The amount is automatically charged via SEPA within 30 days using Mandate ID MID12345 and Creditor ID CID12345 from your account with IBAN [% rescontact.iban %] and BIC [% rescontact.bic %].
 With best regards,
 Your [% rescontact.company %] Service Team

[% rescontact.company %] Company Reg.Nr.: [% rescontact.com.regnum %]
 [% rescontact.street %] VAT.Nr.: [% rescontact.vatnum %]
 [% rescontact.postcode %] [% custcontact.city %] IBAN: [% rescontact.iban %]
 [% rescontact.country %] Page [% aux.page %] BIC: [% rescontact.bic %]

Side panel with layers list will be shown.

The screenshot displays the 'sip:wise NGCP Dashboard' interface. At the top, there is a navigation bar with 'Monitoring & Statistics' and 'Settings' menus. The main content area is titled 'Invoice template TestInvoice'. Below this, there is a 'Back' button and a toolbar with 'Save SVG', 'Preview as PDF', 'Discard Changes', and 'Show Variables'. The main editing area shows a canvas with a ruler and a toolbar on the left. The canvas contains placeholder text for an invoice, including customer details and a date. A 'Layers' panel on the right lists 'Background', 'Summary', and 'CallList', with 'Background' being the active layer.

One of the layers is active, and its element can be edited in the main svg-edit window. Currently active layer's name is **bold** in the layers list. The layers may be visible or invisible. Visible layers have "eye" icon left of their names in the layers list.

To make a layer active, click on its name in the layers list. If the layer was invisible, its elements became visible on activation. Thus you can see mixed elements of some layers, then you can switch off visibility of other layers by click on their "eye" icons. It is good idea to keep visibility of the "Background" layer on, so look of the generated page will be seen.

Edit SVG XML source

Sometimes it may be convenient to edit svg source directly and svg-edit makes it possible to do it. After press on the <svg> icon in the top left corner of the svg-edit interface:

The screenshot shows the 'sip:wise NGCP Dashboard' interface. At the top, there is a navigation bar with 'Monitoring & Statistics' and 'Settings' menus. The main content area is titled 'Invoice template Rechnung_v1'. Below this, there is a 'Back' button and a toolbar with 'Save SVG', 'Preview as PDF', 'Discard Changes', and 'Show Variables'. The main editor area shows a preview of an invoice template with placeholder text for customer details and invoice information.

Placeholder text in the invoice template includes:

- [% custcontact.firstname %] [% custcontact.lastname %]
- [% custcontact.street %]
- [% custcontact.postcode %] [% custcontact.city %]
- [% custcontact.country %]
- Invoice Nr. [% invoice.serial %]
- Customer Nr. [% customer.external_id %]
- Invoice Period [% p_start %] - [% p_end %]
- Date [% date_now(format="%Y-%m-%d") %]

The preview also shows the text: 'Your Monthly Statement' and 'Dear Customer,'.

SVG XML source of the invoice template will be shown.

SVG source can be edited in place or just copy-pasted as usual text.

Note

Template keeps sizes and distances in pixels.



Important

When edit svg xml source, please change very carefully and thoughtfully things inside special comment mark-up "`<!--{ }-->`". Otherwise invoice generation may be broken. Please be sure that document structure repeats default invoice template: has the same groups (`<g/>`) elements on the top level, text inside special comments mark-up "`<!--{ }-->`" preserved or changed appropriately, svg xml structure is correct.

To save your changes in the svg xml source, first press "OK" button on the top left corner of the source page:

The screenshot shows the Sipwise NGCP Dashboard interface. At the top, there's a green header with the logo and navigation links. Below that, the page title is 'Invoice template Default'. A toolbar contains several buttons: 'Back', 'Save SVG', 'Preview as PDF', 'Discard Changes', and 'Show Variables'. A dialog box is open, showing the SVG source code for the invoice template. The code includes variables for page dimensions, server process units, money signs, and various fee calculations based on invoice data.

And then [save invoice template changes](#).

Note

You can copy and keep the svg source of your template as a file on the disk before start experimenting with the template. Later you will be able to return to this version replacing svg source.

Change logo image

- Make sure that "Select tool" is active.
- Select default logo, clicking on the logo image.
- Press "Change image" button, which should appear on the top toolbar.

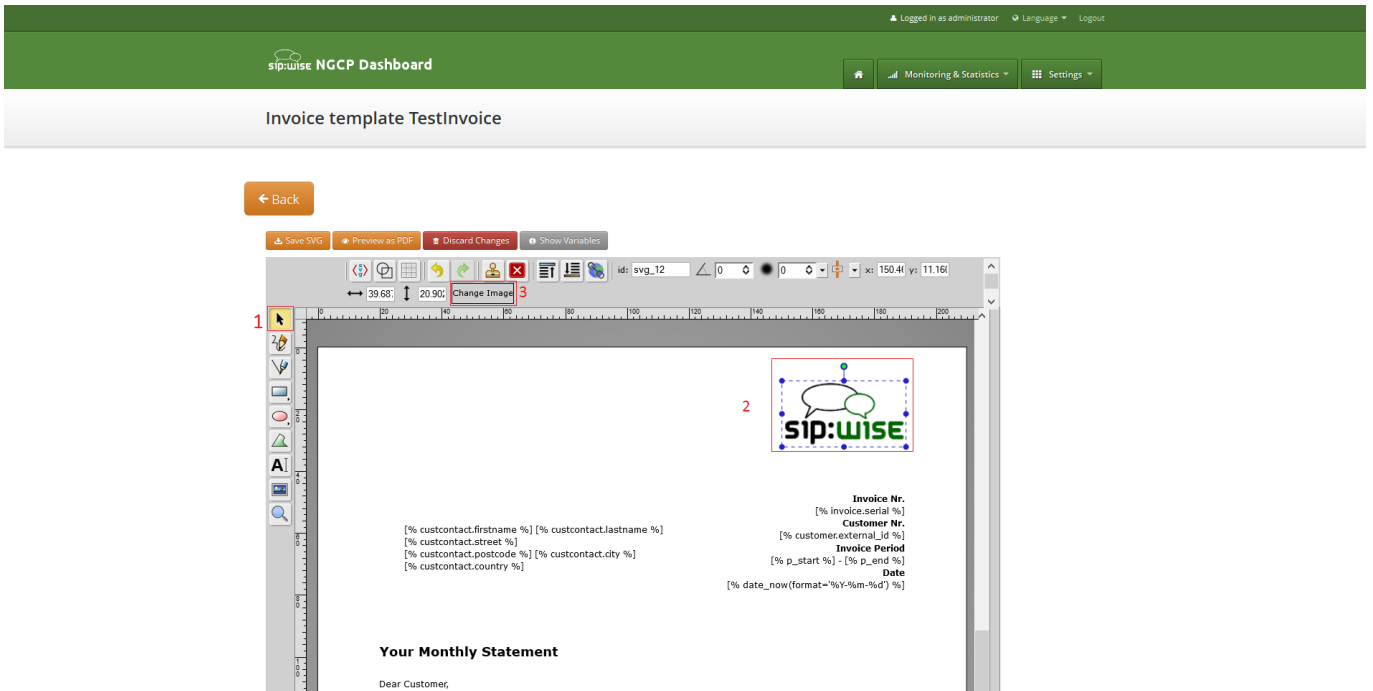

After image uploaded [save invoice template changes](#).

7.19.3.3 Save and preview invoice template content

To save invoice template content changes press button "Save SVG".

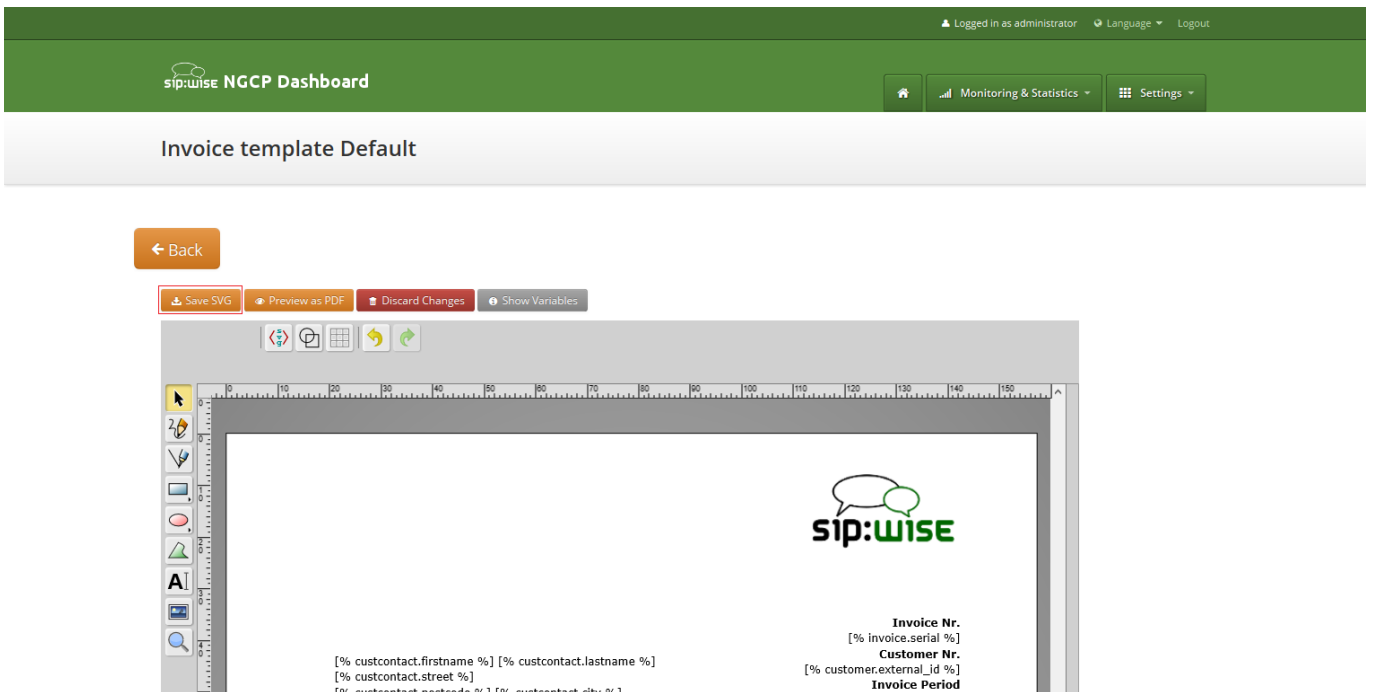

You will see message about successfully saved template. You can preview your invoice look in PDF format. Press on "Preview as PDF" button.

Logged in as administrator Language Logout

sip:wise NGCP Dashboard

Monitoring & Statistics Settings

Invoice template Default

← Back

Invoice template successfully saved



Invoice preview will be opened in the new window.

Note

Example fake data will be used for preview generation.

The screenshot shows a browser window displaying a preview of an invoice. The invoice includes the sip:wise logo at the top right. On the left side, there is a placeholder for customer information: 'Customerfirst Customerlast', 'Customerstreet 12/3', '12345 Customercity', and 'Customercountry'. On the right side, there is a block of invoice details: 'Invoice Nr. 1234567', 'Customer Nr. Resext1234567890', 'Invoice Period 2015-04-01 - 2015-04-30', and 'Date 2015-04-05'. Below this, the heading 'Your Monthly Statement' is followed by a salutation 'Dear Customer,' and a line of text: 'For our services provided in the period of 2015-04-01 to 2015-04-30, we invoice the following items:'. A table titled 'Recurring Fees' follows, with columns for Name, Quantity, Unit Price, and Total Price in EUR. The table contains one row for 'Test Billing Profile' with a quantity of 1, a unit price of 29.90, and a total price of 29.90. A final 'Total' row shows a total price of 29.90.

Name	Quantity	Unit Price	Total Price in EUR
Test Billing Profile	1	29.90	29.90
Total			29.90

7.20 Email Reports and Notifications

7.20.1 Email events

The Sipwise C5 makes it possible to customize content of the emails sent on the following actions:

- Web password reset requested. Email will be sent to the subscriber, whom password was requested for resetting. If the subscriber doesn't have own email, letter will be sent to the customer, who owns the subscriber.
- New subscriber created. Email will be sent to the newly created subscriber or to the customer, who owns new subscriber.
- Letter with the invoice. Letter will be sent to the customer.

7.20.2 Initial template values and template variables

Default email templates for each of the email events are inserted on the initial Sipwise C5 database creation. Content of the default template is described in the corresponding sections. Default email templates aren't linked to any reseller and can't be changed through Sipwise C5 Panel. They will be used to initialize default templates for the newly created reseller.

Each email template refers to the values from the database using special mark-ups "[%" and "%]". Each email template has fixed set of the variables. Variables can't be added or changed without changes in Sipwise C5 Panel code.

7.20.3 Password reset email template

Email will be sent after subscriber or subscriber administrator requested password reset for the subscriber account. Letter will be sent to the subscriber. If subscriber doesn't have own email, letter will be sent to the customer owning the subscriber.

Default content of the password reset email template is:

Template name	passreset_default_email
From	default@sipwise.com
Subject	Password reset email
Body	<p>Dear Customer,</p> <p>Please go to [%url%] to set your password and log into your self-care ↔ interface.</p> <p>Your faithful Sipwise system</p> <p>--</p> <p>This is an automatically generated message. Do not reply.</p>

Following variables will be provided to the email template:

- [%url%]: specially generated url where subscriber can define his new password.
- [%subscriber%]: `username@domain` of the subscriber, which password was requested for reset.

7.20.4 New subscriber notification email template

Email will be sent on the new subscriber creation. Letter will be sent to the newly created subscriber if it has an email. Otherwise, letter will be sent to the customer who owns the subscriber.

Note

By default email content template is addressed to the customer. Please consider this when create the subscriber with an email.

Template name	subscriber_default_email
From	<code>default@sipwise.com</code>
Subject	Subscriber created
Body	<pre> Dear Customer, A new subscriber [%subscriber%] has been created for you. Your faithful Sipwise system -- This is an automatically generated message. Do not reply.</pre>

Following variables will be provided to the email template:

- [%url%]: specially generated url where subscriber can define his new password.
- [%subscriber%]: `username@domain` of the subscriber, which password was requested for reset.

7.20.5 Invoice email template

Template name	invoice_default_email
From	<code>default@sipwise.com</code>
Subject	Invoice #[%invoice.serial%] from [%invoice.period_start_obj.ymd%] to [%invoice.period_end_obj.ymd%]

Body	<pre>Dear Customer, Please find your invoice #[%invoice.serial%] for [%invoice. ← period_start_obj.month_name%], [%invoice.period_start_obj.year%] in attachment letter. Your faithful Sipwise system -- This is an automatically generated message. Do not reply.</pre>
-------------	--

Variables passed to the email template:

- [%**invoice**%]: container variable for the invoice information.

Invoice fields

- [%**invoice.serial**%]
- [%**invoice.amount_net**%]
- [%**invoice.amount_vat**%]
- [%**invoice.amount_total**%]
- [%**invoice.period_start_obj**%]
- [%**invoice.period_end_obj**%]

The fields [%**invoice.period_start_obj**%] and [%**invoice.period_end_obj**%] provide methods of the perl package DateTime for the invoice start date and end date. Further information about DateTime can be obtained from the package documentation:
man DateTime

- [%**provider**%]: container variable for the reseller contact. All database contact values will be available.
- [%**client**%]: container variable for the customer contact.

Contact fields example for the "provider". Replace "provider" to client to access proper "customer" contact fields.

- [%provider.gender%]
- [%provider.firstname%]
- [%provider.lastname%]
- [%provider.comregnum%]
- [%provider.company%]
- [%provider.street%]
- [%provider.postcode%]
- [%provider.city%]
- [%provider.country%]
- [%provider.phonenumber%]
- [%provider.mobilenumber%]
- [%provider.email%]
- [%provider.newsletter%]
- [%provider.faxnumber%]
- [%provider.iban%]
- [%provider.bic%]
- [%provider.vatnum%]
- [%provider.bankname%]
- [%provider.gpp0 - provider.gpp9%]

7.20.6 Email templates management

Email templates linked to the resellers can be customized in the email templates management interface. For the administrative account email templates of all the resellers will be shown. Respectively for the reseller account only owned email templates will be shown.

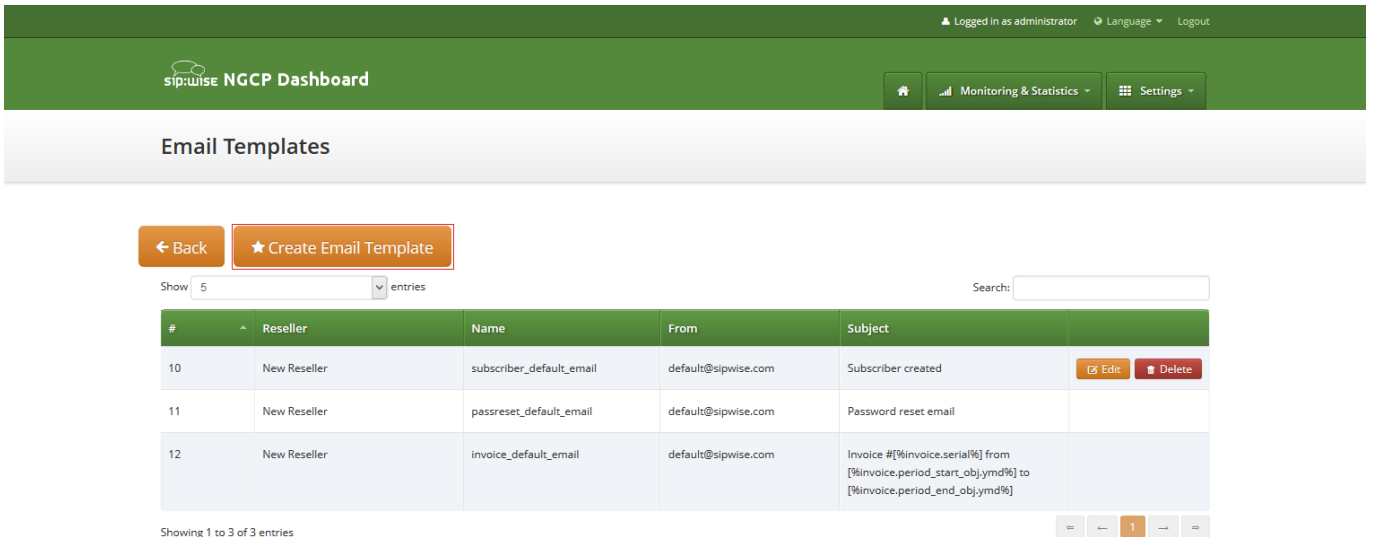

To create new email template press button "Create Email Template".

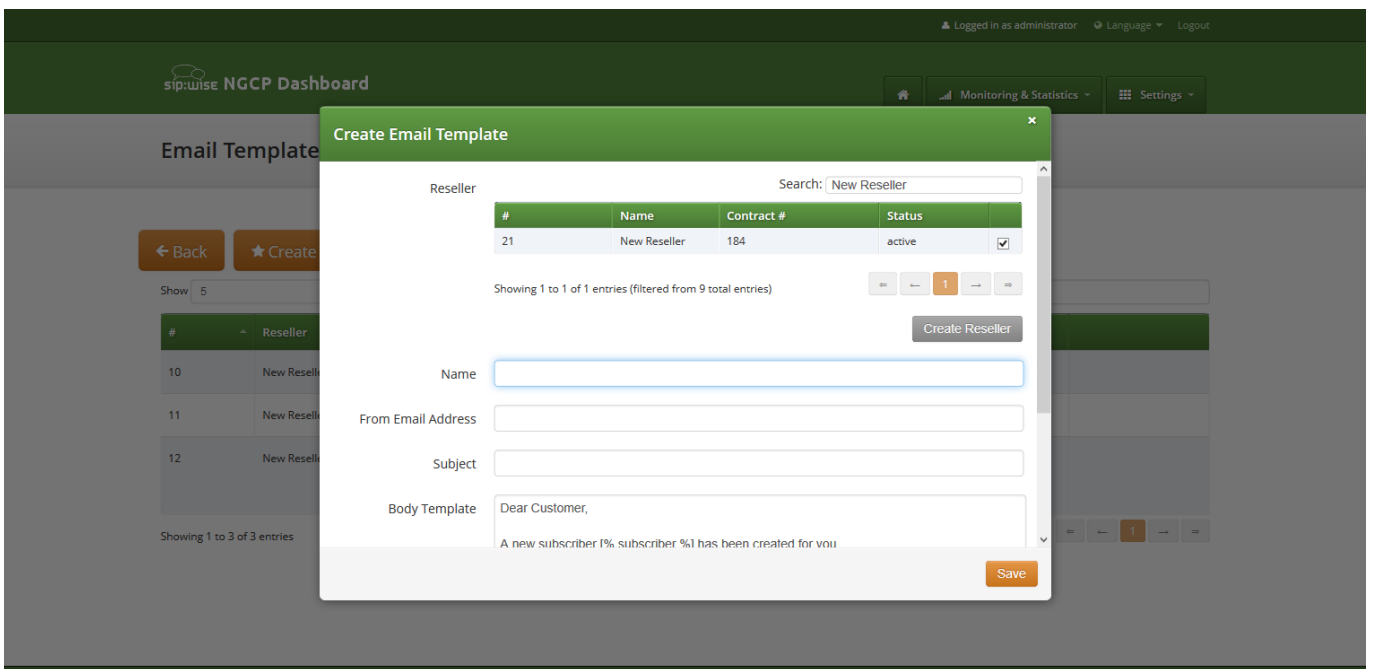

On the email template form all fields are mandatory:

- **Reseller:** reseller who owns this email template.
- **Name:** currently only email template with the following names will be considered by Sipwise C5 on the [appropriate event](#) :
 - passreset_default_email;
 - subscriber_default_email;
 - invoice_default_email;

- **From Email Address:** email address which will be used in the From field in the letter sent by Sipwise C5 .
- **Subject:** Template of the email subject. Subject will be processed with the same template variables as the email body.
- **Body:** Email text template. Will be processed with appropriate template variables.

7.21 The Vertical Service Code Interface

Vertical Service Codes (VSC) are codes a user can dial on his phone to provision specific features for his subscriber account. The format is `*<code>*<value>` to activate a specific feature, and `#<code>` or `#<code>#` to deactivate it. The *code* parameter is a two-digit code, e.g. 72. The *value* parameter is the value being set for the corresponding feature.



Important

The *value* user input is normalized using the Rewrite Rules Sets assigned to domain as described in Section 6.7.

By default, the following codes are configured for setting features. The examples below assume that there is a domain rewrite rule normalizing the number format `0<ac><sn>` to `<cc><ac><sn>` using 43 as country code.

- **72** - enable *Call Forward Unconditional* e.g. to 431000 by dialing `*72*01000`, and disable it by dialing `#72`.
- **90** - enable *Call Forward on Busy* e.g. to 431000 by dialing `*90*01000`, and disable it by dialing `#90`.
- **92** - enable *Call Forward on Timeout* e.g. after 30 seconds of ringing to 431000 by dialing `*92*30*01000`, and disable it by dialing `#92`.
- **93** - enable *Call Forward on Not Available* e.g. to 431000 by dialing `*93*01000`, and disable it by dialing `#93`.
- **50** - set *Speed Dial Slot*, e.g. set slot 1 to 431000 by dialing `*50*101000`, which then can be used by dialing `*1`. There is no code to disable a speed dial slot. When a slot is no longer necessary, it can be ultimately removed using the web interface or can be just ignored, because it is not impacting the calls from and to this subscriber.
- **55** - set *One-Shot Reminder Call* e.g. to 08:30 by dialing `*55*0830`.
- **31** - set *Calling Line Identification Restriction* for one call, e.g. to call 431000 anonymously dial `*31*01000`.
- **32** - enable *Block Incoming Anonymous Calls* by dialing `*32*`, and disable it by dialing `#32`.
- **80** - call using *Call Block Override PIN*, number should be prefixed with a block override PIN configured in admin panel to disable the outgoing user/admin block list and NCOS level for a call. For example, when override PIN is set to 7890, dial `*80*789001000` to call 431000 bypassing block lists.

7.21.1 Configuration of Vertical Service Codes

You can change any of the codes (but not the format) in `/etc/ngcp-config/config.yml` in the section `sems→vsc`. After the changes, execute `ngcpcfg apply "changed VSC codes"`.

**Caution**

If you have the EMTAs under your control, make sure that the specified VSCs don't overlap with EMTA-internal VSCs, because the VSC calls must be sent to Sipwise C5 via SIP like normal telephone calls.

7.21.2 Voice Prompts for Vertical Service Code Configuration

Table 8: VSC Voice Prompts

Prompt Handle	Related VSC	Message
vsc_error	any	An error has occurred. Please try again later.
vsc_invalid	wrong code	Invalid feature code.
reject_vsc	any	Vertical service codes are disabled for this line.
vsc_cfu_on	72 (Call Forward Unconditional)	Your unconditional call forward has successfully been activated.
vsc_cfu_off	72 (Call Forward Unconditional)	Your unconditional call forward has successfully been deactivated.
vsc_cfb_on	90 (Call Forward Busy)	Your call forward on busy has successfully been activated.
vsc_cfb_off	90 (Call Forward Busy)	Your call forward on busy has successfully been deactivated.
vsc_cft_on	92 (Call Forward on Timeout)	Your call forward on ring timeout has successfully been activated.
vsc_cft_off	92 (Call Forward on Timeout)	Your call forward on ring timeout has successfully been deactivated.
vsc_cfna_on	93 (Call Forward on Not Available)	Your call forward while not reachable has successfully been activated.
vsc_cfna_off	93 (Call Forward on Not Available)	Your call forward while not reachable has successfully been deactivated.
vsc_speeddial	50 (Speed Dial Slot)	Your speed dial slot has successfully been stored.
vsc_reminder_on	55 (One-Shot Reminder Call)	Your reminder has successfully been activated.
vsc_reminder_off	55 (One-Shot Reminder Call)	Your reminder has successfully been deactivated.
vsc_blockinclr_on	32 (Block Incoming Anonymous Calls)	Your rejection of anonymous calls has successfully been activated.
vsc_blockinclr_off	32 (Block Incoming Anonymous Calls)	Your rejection of anonymous calls has successfully been deactivated.

7.22 Handling WebRTC Clients

WebRTC is an open project providing browsers and mobile applications with Real-Time Communications (RTC) capabilities. Configuring your platform to offer WebRTC is quite easy and straightforward. This allows you to have a SIP-WebRTC bridge in place and make audio/video call towards normal SIP users from WebRTC clients and vice versa. Sipwise C5 listens, by default, on the following WebSockets and WebSocket Secure: `ws://your-ip:5060/ws`, `wss://your-ip:5061/ws` and `wss://your-ip:1443/wss/sip/`.

The WebRTC subscriber is just a normal subscriber which has just a different configuration in his Preferences. You need to change the following preferences under *Subscribers*→*Details*→*Preferences*→*NAT and Media Flow Control*:

- **use_rtproxy**: Always with `rtproxy` as additional ICE candidate
- **transport_protocol**: RTP/SAVPF (encrypted SRTP with RTCP feedback)

The `transport_protocol` setting may change, depending on your WebRTC client/browser configuration. Supported protocols are the following:

- Transparent (Pass through using the client's transport protocol)
- RTP/AVP (Plain RTP)
- RTP/SAVP (encrypted SRTP)
- RTP/AVPF (RTP with RTCP feedback)
- RTP/SAVPF (encrypted SRTP with RTCP feedback)
- UDP/TLS/RTP/SAVP (Encrypted SRTP using DTLS)
- UDP/TLS/RTP/SAVPF (Encrypted SRTP using DTLS with RTCP feedback)



Warning

The below configuration is enough to handle a WebRTC client/browser. As mentioned, you may need to tune a little bit your `transport_protocol` configuration, depending on your client/browser settings.

In order to have a bridge between normal SIP clients (using plain RTP for example) and WebRTC client, the normal SIP clients' preferences have to have the following configuration:

transport_protocol: RTP/AVP (Plain RTP)

This will teach Sipwise C5 to translate between Plain RTP and RTP/SAVPF when you have calls between normal SIP clients and WebRTC clients.

7.23 XMPP and Instant Messaging

Instant Messaging (IM) based on XMPP comes with Sipwise C5 out of the box. Sipwise C5 uses `prosody` as internal XMPP server. Each subscriber created on the platform have assigned a XMPP user, reachable already - out of the box - by using the same SIP credentials. You can easily open an XMPP client (e.g. Pidgin) and login with your SIP `username@domain` and your SIP `password`. Then, using the XMPP client options, you can create your buddy list by adding your buddies in the format `user@domain`.

7.24 Call Recording

7.24.1 Introduction to Call Recording Function

Sipwise C5 provides an opportunity to record call media content and store that in files. This function is available since mr5.3.1 version of Sipwise C5 .

Some characteristics of the Call Recording:

- Call Recording function can store both unidirectional (originating either from caller, or from callee) or bidirectional (combined) streams from calls, resulting in 1, 2 or 3 physical files as output
- The location and format of the files is configurable.
- File storage is planned to occur on an NFS shared folder.
- Activation of call recording may happen generally for a *Domain / Peer / Subscriber* through Sipwise C5 admin web interface.



Important

NGCP's Call Recording function is not meant for individual call interception purpose! Sipwise provides its Lawful Interception solution for that use case.

- Querying or deletion of existing recordings may happen through the REST API.
- Listing recordings of a subscriber is possible on NGCP's admin web interface.

The Call Recording function is implemented using NGCP's *rtengine* module.

Note

There are 2 *rtengine* daemons employed when call recording is enabled and active. The *main rtengine* takes care of forwarding media packets between caller and callee, as usual, while the *secondary rtengine* (recording) daemon is responsible for storing call data streams in the file system.

Call Recording is disabled by default. Enabling and configuration of Call Recording takes place in 2 steps:

1. Enabling the feature on Sipwise C5 by setting configuration parameters in the main `config.yml` configuration file.
2. Activating the feature for a *Domain / Peer / Subscriber*.

7.24.2 Information on Files and Directories

NGCP's Call Recording function uses an **NFS shared folder** to save recorded streams.



Important

Since call data amount may be huge (depending, of course, on the number and duration of calls), it is *strongly not recommended* to store recorded streams on NGCP's local disks. However if you *have to* store recorded streams as files in the local filesystem, please contact Sipwise Support team in order to get the proper configuration of Call Recording function.

The NFS share gets mounted during startup of the recording daemon. If the NFS share cannot be mounted for some reason, the recording daemon will not start.

Filenames have the format: `<call_ID>-<random>-<SSRC>.<extension>`, where:

- `call_ID`: SIP Call-ID of the call being recorded
- `random`: is a string of random characters, unique for each recorded call. It's purpose is to avoid possible filename collisions if a Call-ID ever gets reused.
- `SSRC`: is the RTP SSRC for unidirectional recordings, or "mix" for the bidirectional (combined) audio.
- `extension`: is either "mp3" or "wav", depending on the configuration (`rtpproxy.recording.output_format`)

There might be 1, 2 or 3 files produced as recorded streams. The **number of files** depends on the configuration:

1. `rtpproxy.recording.output_mixed = 'yes'` (combined stream required)
`rtpproxy.recording.output_single = 'no'` (unidirectional streams not required)
2. `rtpproxy.recording.output_mixed = 'no'` (combined stream not required)
`rtpproxy.recording.output_single = 'yes'` (unidirectional streams required)
3. `rtpproxy.recording.output_mixed = 'yes'` (combined stream required)
`rtpproxy.recording.output_single = 'yes'` (unidirectional streams required)

7.24.3 Configuration

The Call Recording function can be enabled and configured on Sipwise C5 by changing the following configuration parameters in `config.yml` file:

```
rtpproxy:
  ...
  recording:
    enable: no
```

```

mp3_bitrate: '48000'
nfs_host: 192.168.1.1
nfs_remote_path: /var/recordings
output_dir: /var/lib/rtpengine-recording
output_format: wav
output_mixed: yes
output_single: yes
resample: no
resample_to: '16000'
spool_dir: /var/spool/rtpengine

```

7.24.3.1 Enabling Call Recording

Enabling the function requires changing the value of `rtpproxy.recording.enable` parameter to “yes”. In order to make the new configuration active, it's necessary to do:

```
ngcpcfg apply 'Activated call recording'
```

Description of configuration parameters:

- `enable`: when set to “yes” Call Recording function is enabled; default: “no”
- `mp3_bitrate`: the bitrate used when recording happens in MP3 format; default: "48000"
- `nfs_host`: IP address of the NFS host that provides storage space for recorded streams; default: "192.168.1.1"
- `nfs_remote_path`: the remote path (folder) where files of recorded streams are stored on the NFS share; default: "/var/recordings"
- `output_dir`: is the local mount point for the NFS share, and thus where the final audio files will be written; default: "/var/lib/rtpengine-recording"



Caution

Normally you don't need to change the default setting. If you do change the value, please be aware that recorded files will be written by `root` user in that directory.

- `output_format`: possible values are “wav” (Wave) or “mp3” (MP3); default: “wav”
- `output_mixed`: “yes” means that there is a file that contains a mixed stream of caller and callee voice data; default: "yes"
- `output_single`: “yes” means that there is a separate file for each stream direction, i.e. for the streams originating from caller and callee; default: "yes"
- `resample`: when set to “yes” the call data stream will be resampled before storing it in the file; default: “no”
- `resample_to`: the sample rate used for resampling output; default: "16000"

- `spool_dir`: is the place for temporary metadata files that are used by the recording daemon and the main `rtengine` daemon for their communication; default: `"/var/spool/rtengine"`



Caution

You should not change the default setting unless you have a good reason to do so! Sipwise has thoroughly tested the Call Recording function with the default setting.

If Call Recording is enabled you can see 2 `rtengine` processes running when checking Sipwise C5 system state with `ngcp-service` tool:

```
root@sp1:/etc/ngcp-config# ngcp-service summary
Ok Service                               Managed   Started   Status
-----
...
  kamailio-lb                             managed   by-ha     active
  ngcp-voisniff                           managed   by-ha     active
  rtengine                                 managed   by-ha     active
  rtengine-recording                      managed   by-ha     active
...
```

7.24.3.2 Activating Call Recording

Activating Call Recording for e.g. a *Subscriber*: please use NGCP's admin web interface for this purpose. On the web interface one has to navigate as follows: *Settings* → *Subscribers* → *select subscriber Details* → *Preferences* → *NAT and Media Flow Control*. Afterwards the `record_call` option has to be enabled by pressing the *Edit* button and ticking the checkbox.

NAT and Media Flow Control				
	Attribute	Name	Value	
	sound_set	System Sound Set	<input type="text"/>	
	use_rtpproxy	RTP-Proxy Mode	use domain default	
	ipv46_for_rtpproxy	IPv4/IPv6 bridging mode	use domain default	
	contract_sound_set	Customer Sound Set	<input type="text"/>	
	music_on_hold	Music on Hold	<input type="checkbox"/>	
	bypass_rtpproxy	Disable RTP-Proxy in the selected case	use domain default	
	rtp_interface	RTP interface	default	
	transport_protocol	Media transport protocol	use domain default	
	set_moh_sendonly	MoH sendonly	<input type="checkbox"/>	
	codecs_filter	Codecs filter	<input type="checkbox"/>	
	codecs_list	Codecs list		
	record_call	Record calls	<input type="checkbox"/>	Edit

Figure 61: Activating Call Recording

Note

The call recording function may be activated for a single *Subscriber*, a *Domain* and a *Peer* server in the same way: *Preferences* → *NAT and Media Flow Control* → *record_call*. When activating call recording for a *Domain* or *Peer* this effectively activates the function for all subscribers that belong to the selected domain, and for all calls with a local endpoint going through the selected peer server, respectively.

It is possible to **list existing call recordings** of a *Subscriber* through the admin web interface of NGCP. In order to do so, please navigate to: *Settings* → *Subscribers* → *select subscriber Details* → *Call Recordings*

Subscriber 43993002@10.15.18.222

← Back | Preferences | Calls history | Customer | Expand Groups

Master Data

Groups

Voice Mails

Call Recordings

From Date: To Date: Search:

#	Time	Call-ID
1	2017-09-05 11:51:41.543	17d5b961-7613-4ba2-9bc4-fb8086e2ccdd

Showing 1 to 1 of 1 entries

Figure 62: Listing Call Recordings

If you select an item in the list, besides the main properties such as the time of call and the SIP Call-ID, you can retrieve the details of the related call (press the *Call Details* button), get the list of recorded files (press the *Recorded Files* button) or *Delete* the recorded call.

When selecting *Call Details* you will see the most important accounting data of the call. Furthermore you can see the SIP *Call Flow* or the complete *Call Details* if you press the respective buttons.

Call List for 43993002@10.15.18.222 ()

← Back

Show all calls

Show 5 entries From Date: To Date: Search:

#	Caller	Callee	CLIR	Billing zone	Status	Start Time	Duration	Call-ID	Cost
5	43993002	43993003	0	All Destinations	ok	2017-09-05 11:51:47.855	0:00:10.437	17d5b961-7613-4ba2-9bc4-fb8086e2ccdd	0.00
Total							0:00:10.437		0.00

Showing 1 to 1 of 1 entries

Figure 63: Listing Call Details for a Recording

When navigating to *Recorded Files* of a call you will be presented with a list of files. For each file item:

- type of stream is shown, that can be either "mixed" (combined voice data), or "single" (voice data of caller or callee)

- file `format` is shown, that can be either "wav", or "mp3"
- you can download the file by pressing the *Play* button

#	Type	Format
1	mixed	wav
3	single	wav
5	single	wav

Showing 1 to 3 of 3 entries

Figure 64: Listing Files for a Recording

7.24.4 REST API

The Sipwise C5 REST API provides methods for querying and deletion of existing recording data. The full documentation of the available API methods is available on the admin web interface of the NGCP, as usual.

The following API methods are provided for managing Call Recordings:

- CallRecordings:
 - Provides information about the calls recorded in the system; can also be used to delete a recording entry
 - accessible by the path: `/api/callrecordings` (collection) or `/api/callrecordings/id` (single item)
 - Supported HTTP methods: OPTIONS, GET, DELETE
- CallRecordingStreams:
 - Provides information about recorded streams, such as start time, end time, format, mixed/single type, etc.; can also be used to delete a recorded stream
 - accessible by the path: `/api/callrecordingstreams` (collection) or `/api/callrecordingstreams/id` (single item)
 - Supported HTTP methods: OPTIONS, GET, DELETE
- CallRecordingFiles:
 - Provides information about recorded streams, such as start time, end time, format, mixed/single type, etc.; additionally returns the file content too
 - accessible by the path: `/api/callrecordingfiles` (collection) or `/api/callrecordingfiles/id` (single item)
 - Supported HTTP methods: OPTIONS, GET

7.24.5 Pre-Recording Announcement

Many country regulations require that an informative announcement is played to the caller before the call is actually recorded. The Sipwise C5 allows you to configure your own custom announcement with few simple steps.

First create a system sound set for the feature. In *Settings* → *Sound Sets* either use your already existing *Sound Set* or create a new *Sound Set* and then assign it to your domain or subscribers. In the *Sound Set* there is an announcement *early_rejects* → *announce_before_recording* for that purpose.

Once the *Sound Set* is created the subscriber's preference *play_announce_before_recording* of the callee must be enabled under *Subscriber* → *Preferences* → *Applications* menu. The same parameter can be set in the Domain's or Customer's preferences to enable this feature for all its subscribers.

Note

The announcement will be played to caller before the call is routed to the callee.



Important

In case of **CFU** or **CFNA** with Pre-Recording Announcement feature enabled on both the forwarder and the final callee, only the Announcement of final callee will be played to caller. In case of **CFB** and **CFT**, instead, the announcement of the forwarder will be played first, then the announcement of final callee will be played after the call forward is executed.

7.25 Media Transcoding

7.25.1 Overview

Starting with version mr6.2.1, Sipwise C5 offers the capability to convert RTP media between several supported codecs, a feature known as transcoding. While this feature is always available on Sipwise C5, it's engaged only when a subscriber, peer, or domain is explicitly configured for it. By default, Sipwise C5 lets RTP endpoints negotiate the codec to use among themselves without interfering.



Important

Media transcoding is a relatively CPU-intensive feature. As such, each individual node of a Sipwise C5 performing media transcoding can only support a limited number of concurrent calls for which transcoding is active.

7.25.2 Supported Codecs

The following audio codecs, which are commonly found in use by SIP/RTP clients, are currently supported for transcoding.

- G.711 (μ -Law and a-Law)
- G.722

- G.723.1
- G.729
- GSM
- AMR (narrowband and wideband, the latter also known as AMR-WB)
- Opus
- Speex
- DTMF event packets (**telephone-event**)

Some codecs operate at different sampling rates than other codecs. If transcoding happens between two such codecs, the audio will be resampled as necessary. Similarly, if transcoding happens between a mono (1-channel) and a stereo (2-channel) codec, the audio will be up-mixed and down-mixed as necessary.

7.25.3 Configuration

Transcoding can be engaged for individual subscribers, peers, or domains on their respective preferences page in the Sipwise C5 admin web interface.

Media Codec Transcoding Options			
Attribute	Name	Value	
<input type="checkbox"/>	ptime	RTP packet interval	use domain default
<input type="checkbox"/>	transcode_PCMU	Transcode to G.711 μ-Law	<input type="checkbox"/>
<input type="checkbox"/>	transcode_PCMA	Transcode to G.711 a-Law	<input type="checkbox"/>
<input type="checkbox"/>	transcode_G722	Transcode to G.722	<input type="checkbox"/>
<input type="checkbox"/>	transcode_G723	Transcode to G.723.1	<input type="checkbox"/>
<input type="checkbox"/>	transcode_G729	Transcode to G.729	<input type="checkbox"/>
<input type="checkbox"/>	transcode_GSM	Transcode to GSM	<input type="checkbox"/>
<input type="checkbox"/>	transcode_AMR	Transcode to AMR	<input type="checkbox"/>
<input type="checkbox"/>	transcode_AMR_WB	Transcode to AMR-WB	<input type="checkbox"/>
<input type="checkbox"/>	transcode_opus_mono	Transcode to Opus mono	<input type="checkbox"/>
<input type="checkbox"/>	transcode_opus_stereo	Transcode to Opus stereo	<input type="checkbox"/>
<input type="checkbox"/>	transcode_speex_8	Transcode to Speex 8 kHz	<input type="checkbox"/>
<input type="checkbox"/>	transcode_speex_16	Transcode to Speex 16 kHz	<input type="checkbox"/>
<input type="checkbox"/>	transcode_speex_32	Transcode to Speex 32 kHz	<input type="checkbox"/>
<input type="checkbox"/>	opus_mono_bitrate	Opus mono bitrate	use domain default
<input type="checkbox"/>	opus_stereo_bitrate	Opus stereo bitrate	use domain default
<input type="checkbox"/>	g723_bitrate	G.723.1 bitrate	use domain default
<input type="checkbox"/>	always_transcode	Always transcode media from the user	<input type="checkbox"/>

Figure 65: Transcoding Configuration

Setting any of the transcoding options for a domain makes it affect all the subscribers in this domain.

Individual options are described below.

7.25.3.1 ptime

Packetisation time in milliseconds. Normally Sipwise C5 lets the RTP endpoints select and negotiate the packetisation time they want to use. Setting this option to anything other than `unchanged` will engage the transcoding engine towards this subscriber or peer even if none of the other transcoding options are set, in which case the media will simply be repacketised.

For example, setting this to `40 ms` would mean that each RTP packet sent towards this subscriber or peer would contain 40 milliseconds worth of audio, even if the other side of the call sends media that is packetised differently. It would also make Sipwise C5 indicate towards this subscriber or peer that it would prefer to receive audio in 40 millisecond packets (through the `a=ptime` SDP attribute).

7.25.3.2 transcode_...

Enabling one of these options adds the selected codecs to the list of codecs offered to this subscriber or peer, even if the original list of offered codecs did not include it. If this additional codec ends up being accepted by this subscriber or peer, then it will be transcoding to the first supported codec that was originally offered.

For example, if a calling RTP client A indicates support for PCMA (G.711 a-Law) as well as G.722, and calls a subscriber B that is configured for transcoding to G.729, then subscriber B would be offered PCMA, G.722, and G.729 by Sipwise C5. If subscriber B then accepts G.729 and starts sending G.729, Sipwise C5 would engage its transcoding engine and transcode the audio to PCMA (because PCMA and not G.722 was the codec preferred by A) before forwarding it to A. Vice versa, PCMA arriving from A would be transcoded to G.729 before being sent to B. (If B were to reject G.729 and instead starts to send PCMA or G.722, no transcoding would happen.)

Notes on individual codecs:

- **AMR** is available in both narrowband (`AMR` operating at 8 kHz) and wideband (`AMR-WB` operating at 16 kHz) variants. These are distinct codecs and can be configured for transcoding separately or together.
- **Opus** always operates at 48 kHz, but is supported in both mono and stereo (1 and 2 audio channels respectively). Both can be offered at the same time if so desired.
- **Speex** is supported at sampling rates of 8, 16, and 32 kHz. These can be configured separately for transcoding, or together.
- **DTMF** is not an actual audio codec, but rather represents transcoding between DTMF event packets and in-band DTMF audio tones. This is described in more detail below.

7.25.3.3 ..._bitrate

Some codecs (Opus and G.723.1 in particular) can be configured for different bitrates, which would impact the amount of network bandwidth they use, as well as the audio quality produced. For Opus, different bitrates can be selected for their mono and stereo instances. Selecting a bitrate has no effect if transcoding to the respective codec is not engaged.

7.25.3.4 `always_transcode`

Setting this flag instructs Sipwise C5 to always engage transcoding to the first (preferred) codec indicated by an RTP endpoint, even if another codec is available that is supported by both parties to a call. Enabling this flag can potentially engage the transcoding engine for a call even if none of the other transcoding options are set.

For example: Subscriber A is calling subscriber B. Subscriber A is indicating support for PCMA and G.722. Subscriber B answers the call, rejects PCMA but accepts G.722, and starts sending G.722 to A. Normally Sipwise C5 would not get involved and would simply let G.722 pass between A and B. But if subscriber B has the `always_transcode` flag set, Sipwise C5 would now start transcoding the G.722 sent by B into PCMA before forwarding it to A, because PCMA was indicated as the preferred codec by A. Vice versa, PCMA arriving from A would be transcoded into G.722 and then forwarded to B.

7.25.3.5 DTMF transcoding

Sipwise C5 supports transcoding between DTMF event packets (using the RTP `telephone-event` type payload) and DTMF tones carried in-band in the audio stream. DTMF transcoding is supported in both directions: transcoding DTMF event packets to DTMF tones, and DTMF tones in an audio stream and transcoding them to DTMF event packets.

Support for DTMF transcoding can be enabled in one of two ways:

- Enabling the setting `transcode_dtmf` for a subscriber, peer, or domain. This is useful if the subscriber, peer, or domain requires support for DTMF event packets, but the calling entity might only support DTMF tones carried in-band in the audio stream.
- Enabling the setting `always_transcode` for a subscriber, peer, or domain. This is useful for the reverse case: if the subscriber, peer, or domain might only support DTMF tones carried in-band in the audio stream, but the calling entity requires support for DTMF event packets.

Enabling DTMF transcoding for any call requires that all audio passes through the transcoding engine, as well as a DSP for detecting DTMF tones in one direction. This carries an additional performance impact with it, and so DTMF transcoding should only be enabled when really necessary.

7.26 Announcement Before Call Setup

This feature allows a callee to play a custom announcement to the caller every time it receives a call. The announcement is played in early media mode, therefore it can be used as a simple business welcome message or to inform the caller about a different cost of the call before it will be actually charged.

The configuration of the announcement is similar to the activation of [Pre-Recording Announcement](#) and it requires few simple steps.

First create a system sound set for the feature. In *Settings* → *Sound Sets* either use your already existing *Sound Set* or create a new *Sound Set* and then assign it to your domain or subscribers. In the *Sound Set* there is an announcement `early_rejects` → `announce_before_call_setup` for that purpose.

Once the *Sound Set* is created the subscriber's preference `play_announce_before_call_setup` must be enabled under *Subscriber*

→ *Preferences* → *Applications* menu. The same parameter can be set in the Domain's or Customer's preferences to enable this feature for all its subscribers.

Note

The announcement will be played to caller before the call is routed to the callee.

**Important**

Differently from *Pre-Recording Announcement*, in all **Call Forward** cases with *Announcement Before Call Setup* feature enabled on both the forwarder and the final callee, only the announcement of the forwarder will be played to caller.

This feature and *Pre-Recording Announcement* can be activated at the same time. In this case the *Announcement Before Call Setup* will be played as first.

7.27 SMS (Short Message Service) on Sipwise C5

Starting with its mr5.0.1 release, Sipwise C5 offers *short messaging service* to its local subscribers. The implementation is based on a widely used software module: *Kannel*, and it needs to interact with a mobile operator's SMSC in order to send and receive SMS for the local subscribers. The data exchange with SMSC uses *SMPP* (Short Message Peer-to-Peer) protocol.

SMS directions:

- incoming / received: the destination of the SM is a local subscriber on the NGCP
- outgoing / sent: the SM is submitted by a local subscriber

Note

The Sipwise C5 behaves as a short message client towards the SMSC of a mobile operator. This means every outgoing SM will be forwarded to the SMSC, and every incoming SM will reach Sipwise C5 through an SMSC.

The architecture of the SMS components of Sipwise C5 and their interaction with other elements is depicted below:

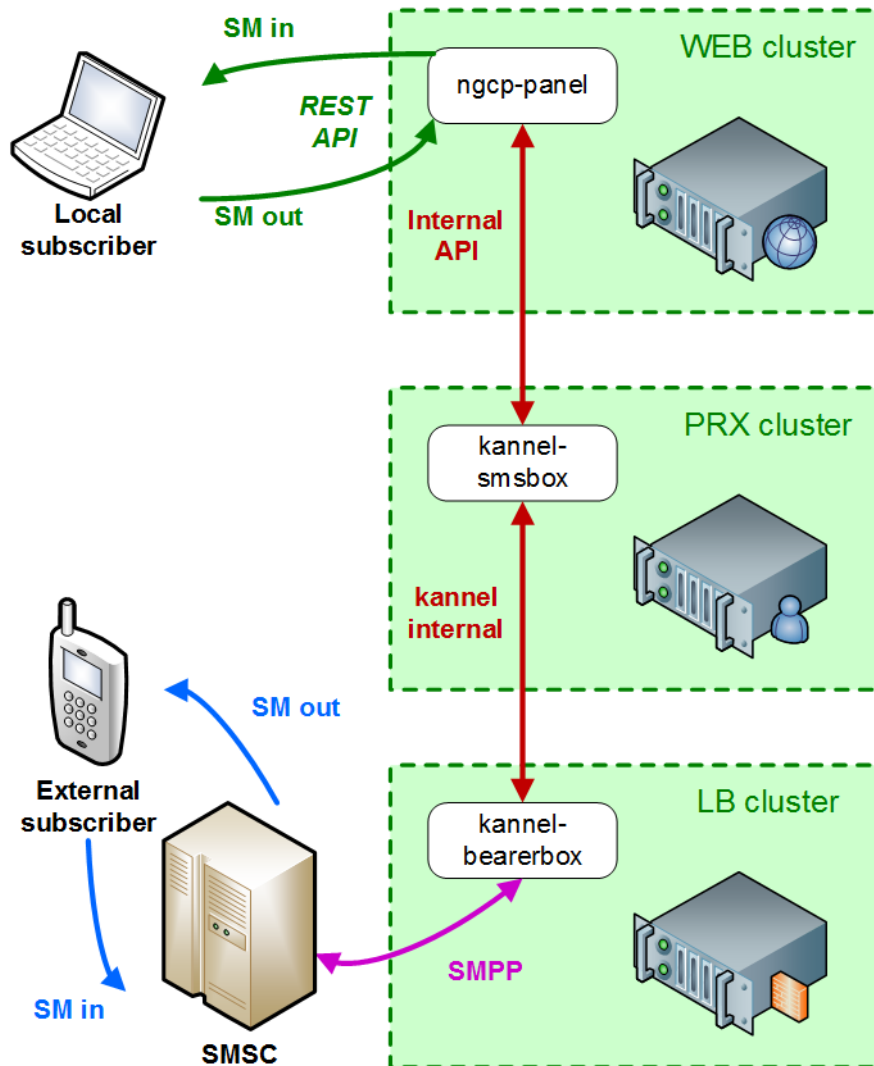

Figure 66: SMS Interaction

Note

For the *Sipwise C5 CE and PRO* installations: the *Kannel* components and the *ngcp-panel* all run on the same single node. The description of SMS module will continue referring to a *Sipwise C5 CARRIER* installation in the handbook.

There are 2 components of the SMS module:

- **SMS Box:** this component takes care of handling the messages locally, that means:
 - delivering them to subscribers (writing into database for later retrieval)
 - picking up the submitted SMSs from the database and forwarding them to the *Bearer Box* component
- **Bearer Box:** this component manages the transmission of SMSs between Sipwise C5 and the mobile operator's SMSC

7.27.1 Configuration

7.27.1.1 Main Parameters

The SMS functionality of Sipwise C5 is disabled by default. In order to **enable SMS**, change the value of configuration parameter `sms.enable` to `yes` in the main configuration file (`/etc/ngcp-config/config.yml`).

The second step of configuration is related to the **SMSC** where Sipwise C5 will connect to. Set the following parameters:

- `sms.smsc.host`: IP address of the SMSC
- `sms.smsc.port`: Port number of the SMSC
- `sms.smsc.username`: Username for authentication on the SMSC
- `sms.smsc.password`: Password for authentication on the SMSC

Other parameters of the SMSC connection may also need to be changed from the default values, but this is specific to each deployment.

Then, as usual, you have to make the new configuration active:

```
$ ngcpcfg apply 'Enabled SMS'
```

7.27.1.2 Configuration Files of Kannel

There are a few configuration files for the *Kannel* module, namely:

- `/etc/default/ngcp-kannel`: determines which components of *Kannel* will be started. This is auto-generated from `/etc/ngcp-config/templates/etc/default/ngcp-kannel.tt2` file when SMS is enabled.
- `/etc/kannel/kannel.conf`: contains detailed configuration of *Kannel* components. This is auto-generated from `/etc/ngcp-config/templates/etc/kannel/kannel.conf.tt2` file when SMS is enabled.
- `/etc/logrotate.d/ngcp-kannel.conf`: configuration of *logrotate* for *Kannel* log files. This is auto-generated from `/etc/ngcp-config/templates/etc/logrotate.d/ngcp-kannel.conf.tt2` file when SMS is enabled.



Caution

Please do not change settings in the above mentioned template files, unless you have to tailor *Kannel* settings to your specific needs!

Finally: see the description of each configuration parameter in the [appendix](#).

7.27.1.3 Call Forwarding for SMS (CFS)

Any subscriber registered on Sipwise C5 can apply a call forwarding setting for short messages, referred to as "CFS" (Call Forward - SMS). If the CFS feature is enabled, he can receive the SMs on his mobile phone, for example, instead of retrieving the SMs through the REST API. This is much more convenient for users if they do not have an application on their smartphone or computer that could manage the SMs through the REST API.

In order to enable CFS you have to set the forwarding as usual on the admin web interface, or through the REST API. Navigate to *Subscribers* → *select one* → *Details* → *Preferences* → *Call Forwards* and press the *Edit* button.

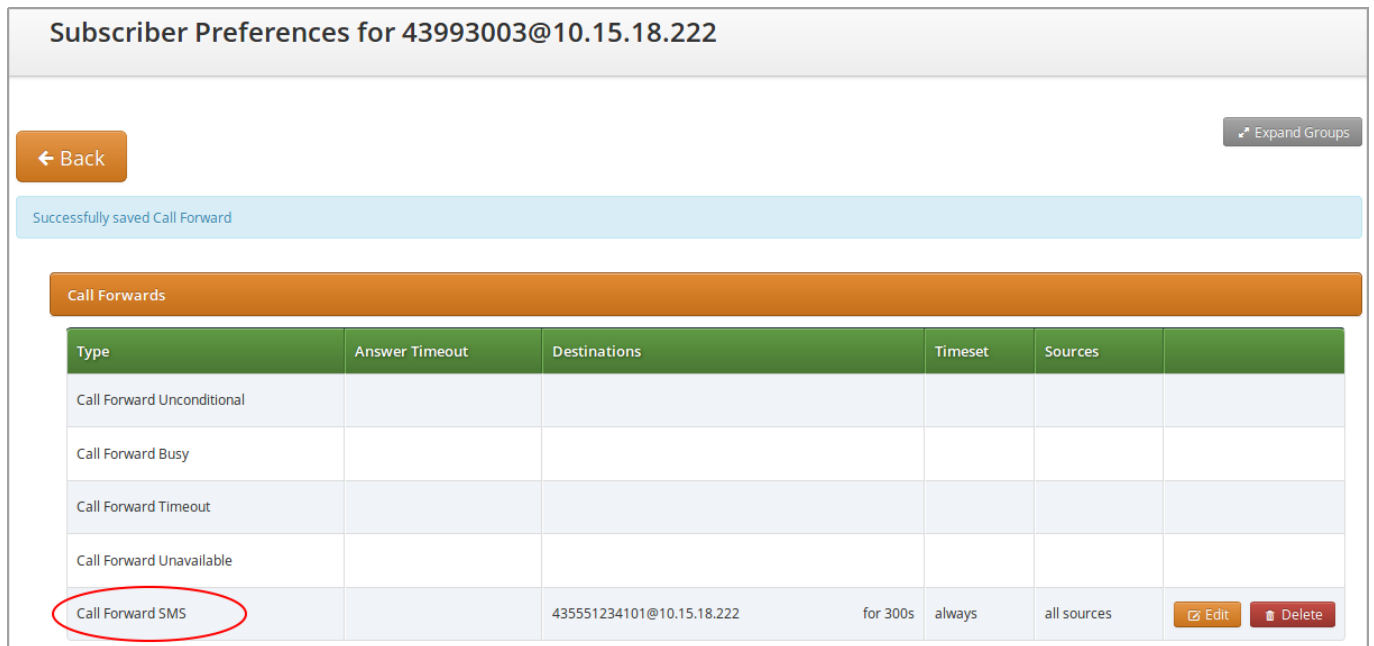

Subscriber Preferences for 43993003@10.15.18.222

← Back Expand Groups

Successfully saved Call Forward

Call Forwards

Type	Answer Timeout	Destinations	Timeset	Sources	
Call Forward Unconditional					
Call Forward Busy					
Call Forward Timeout					
Call Forward Unavailable					
Call Forward SMS		435551234101@10.15.18.222	for 300s	always	all sources Edit Delete

Figure 67: Call Forward for SMS

7.27.2 Monitoring, troubleshooting

7.27.2.1 Bearer Box (LB node of NGCP)

On the LB node you can see a **process** named "**bearerbox**". This process has 2 **listening ports** assigned to it:

- 13000: this is the generic *Kannel* administration port, that belongs to the "core" component of Kannel.
- 13001: this is the communication port towards the *SMS Box* component running on PRX nodes of NGCP.

The *ngcp-service* tool also shows the *bearerbox* process in its summary information:

```
$ ngcp-service summary
Ok Service                Managed   Started   Status
-----
```

```
...
kannel-bearerbox          managed    by-ha     active
...
```

The following log files can provide information about the operation of *Bearer Box*:

- status messages and high level, short entries about sent and received messages: `/var/log/ngcp/kannel/kannel.log`

```
...
2017-09-26 08:57:32 [15922] [10] DEBUG: boxc_receiver: heartbeat with load value 0 ↔
    received
...
2017-09-26 11:12:06 [15922] [10] DEBUG: boxc_receiver: sms received
2017-09-26 11:12:06 [15922] [10] DEBUG: send_msg: sending msg to box: <192.168.1.4>
2017-09-26 11:12:06 [15922] [11] DEBUG: send_msg: sending msg to box: <192.168.1.4>
2017-09-26 11:12:06 [15922] [11] DEBUG: boxc_sender: sent message to <192.168.1.4>
2017-09-26 11:12:06 [15922] [10] DEBUG: boxc_receiver: got ack
...
```

- detailed information and message content of sent and received messages, link enquiries: `/var/log/kannel/smsc.log`

Note

Sent and received message examples shown here do not contain the full phone number and content for confidentiality reason.

- Example received message:

```
...
2017-09-26 12:09:36 [15922] [6] DEBUG: SMPP[default_smsc]: Got PDU:
2017-09-26 12:09:36 [15922] [6] DEBUG: SMPP PDU 0x7f2274025070 dump:
2017-09-26 12:09:36 [15922] [6] DEBUG:   type_name: deliver_sm
2017-09-26 12:09:36 [15922] [6] DEBUG:   command_id: 5 = 0x00000005
2017-09-26 12:09:36 [15922] [6] DEBUG:   command_status: 0 = 0x00000000
2017-09-26 12:09:36 [15922] [6] DEBUG:   sequence_number: 11867393 = 0x00b51501
2017-09-26 12:09:36 [15922] [6] DEBUG:   service_type: NULL
2017-09-26 12:09:36 [15922] [6] DEBUG:   source_addr_ton: 2 = 0x00000002
2017-09-26 12:09:36 [15922] [6] DEBUG:   source_addr_npi: 1 = 0x00000001
2017-09-26 12:09:36 [15922] [6] DEBUG:   source_addr: "0660....."
2017-09-26 12:09:36 [15922] [6] DEBUG:   dest_addr_ton: 1 = 0x00000001
2017-09-26 12:09:36 [15922] [6] DEBUG:   dest_addr_npi: 1 = 0x00000001
2017-09-26 12:09:36 [15922] [6] DEBUG:   destination_addr: "43668....."
2017-09-26 12:09:36 [15922] [6] DEBUG:   esm_class: 0 = 0x00000000
2017-09-26 12:09:36 [15922] [6] DEBUG:   protocol_id: 0 = 0x00000000
2017-09-26 12:09:36 [15922] [6] DEBUG:   priority_flag: 0 = 0x00000000
2017-09-26 12:09:36 [15922] [6] DEBUG:   schedule_delivery_time: NULL
```



```

2017-09-26 12:09:36 [15922] [6] DEBUG:   validity_period: NULL
2017-09-26 12:09:36 [15922] [6] DEBUG:   registered_delivery: 0 = 0x00000000
2017-09-26 12:09:36 [15922] [6] DEBUG:   replace_if_present_flag: 0 = 0x00000000
2017-09-26 12:09:36 [15922] [6] DEBUG:   data_coding: 3 = 0x00000003
2017-09-26 12:09:36 [15922] [6] DEBUG:   sm_default_msg_id: 0 = 0x00000000
2017-09-26 12:09:36 [15922] [6] DEBUG:   sm_length: 158 = 0x0000009e
2017-09-26 12:09:36 [15922] [6] DEBUG:   short_message:
2017-09-26 12:09:36 [15922] [6] DEBUG:     Octet string at 0x7f227400f80:
2017-09-26 12:09:36 [15922] [6] DEBUG:       len: 158
2017-09-26 12:09:36 [15922] [6] DEBUG:       size: 159
2017-09-26 12:09:36 [15922] [6] DEBUG:       immutable: 0
2017-09-26 12:09:36 [15922] [6] DEBUG:       data: 5a <14 bytes> 46
2017-09-26 12:09:36 [15922] [6] DEBUG:       data: 72 <14 bytes> 68
2017-09-26 12:09:36 [15922] [6] DEBUG:       data: 61 <14 bytes> 67
2017-09-26 12:09:36 [15922] [6] DEBUG:       data: 20 <14 bytes> 57
2017-09-26 12:09:36 [15922] [6] DEBUG:       data: 65 <14 bytes> 63
2017-09-26 12:09:36 [15922] [6] DEBUG:       data: 68 <14 bytes> 73
2017-09-26 12:09:36 [15922] [6] DEBUG:       data: 2e <14 bytes> 61
2017-09-26 12:09:36 [15922] [6] DEBUG:       data: 6c <14 bytes> 73
2017-09-26 12:09:36 [15922] [6] DEBUG:       data: 3a <14 bytes> 73
2017-09-26 12:09:36 [15922] [6] DEBUG:       data: 4d <14 bytes> 6e
2017-09-26 12:09:36 [15922] [6] DEBUG:     Octet string dump ends.
2017-09-26 12:09:36 [15922] [6] DEBUG: SMPP PDU dump ends.
2017-09-26 12:09:36 [15922] [6] DEBUG: SMPP[default_smsc]: Sending PDU:
2017-09-26 12:09:36 [15922] [6] DEBUG: SMPP PDU 0x7f2274020790 dump:
2017-09-26 12:09:36 [15922] [6] DEBUG:   type_name: deliver_sm_resp
2017-09-26 12:09:36 [15922] [6] DEBUG:   command_id: 2147483653 = 0x80000005
2017-09-26 12:09:36 [15922] [6] DEBUG:   command_status: 0 = 0x00000000
2017-09-26 12:09:36 [15922] [6] DEBUG:   sequence_number: 11867393 = 0x00b51501
2017-09-26 12:09:36 [15922] [6] DEBUG:   message_id: NULL
2017-09-26 12:09:36 [15922] [6] DEBUG: SMPP PDU dump ends.
2017-09-26 12:09:36 [15922] [6] DEBUG: SMPP[default_smsc]: throughput (0.00,5.00)
...

```

– Example sent message:

```

...
2017-09-26 12:04:08 [15922] [6] DEBUG: SMPP[default_smsc]: throughput (0.00,5.00)
2017-09-26 12:04:08 [15922] [6] DEBUG: SMPP[default_smsc]: Manually forced source addr ↔
   ton = 1, source add npi = 1
2017-09-26 12:04:08 [15922] [6] DEBUG: SMPP[default_smsc]: Manually forced dest addr ton ↔
   = 1, dest add npi = 1
2017-09-26 12:04:08 [15922] [6] DEBUG: SMPP[default_smsc]: Sending PDU:
2017-09-26 12:04:08 [15922] [6] DEBUG: SMPP PDU 0x7f2274025070 dump:
2017-09-26 12:04:08 [15922] [6] DEBUG:   type_name: submit_sm
2017-09-26 12:04:08 [15922] [6] DEBUG:   command_id: 4 = 0x00000004
2017-09-26 12:04:08 [15922] [6] DEBUG:   command_status: 0 = 0x00000000

```

```

2017-09-26 12:04:08 [15922] [6] DEBUG: sequence_number: 98163 = 0x00017f73
2017-09-26 12:04:08 [15922] [6] DEBUG: service_type: NULL
2017-09-26 12:04:08 [15922] [6] DEBUG: source_addr_ton: 5 = 0x00000005
2017-09-26 12:04:08 [15922] [6] DEBUG: source_addr_npi: 0 = 0x00000000
2017-09-26 12:04:08 [15922] [6] DEBUG: source_addr: "any"
2017-09-26 12:04:08 [15922] [6] DEBUG: dest_addr_ton: 1 = 0x00000001
2017-09-26 12:04:08 [15922] [6] DEBUG: dest_addr_npi: 1 = 0x00000001
2017-09-26 12:04:08 [15922] [6] DEBUG: destination_addr: "43676....."
2017-09-26 12:04:08 [15922] [6] DEBUG: esm_class: 3 = 0x00000003
2017-09-26 12:04:08 [15922] [6] DEBUG: protocol_id: 0 = 0x00000000
2017-09-26 12:04:08 [15922] [6] DEBUG: priority_flag: 0 = 0x00000000
2017-09-26 12:04:08 [15922] [6] DEBUG: schedule_delivery_time: NULL
2017-09-26 12:04:08 [15922] [6] DEBUG: validity_period: NULL
2017-09-26 12:04:08 [15922] [6] DEBUG: registered_delivery: 0 = 0x00000000
2017-09-26 12:04:08 [15922] [6] DEBUG: replace_if_present_flag: 0 = 0x00000000
2017-09-26 12:04:08 [15922] [6] DEBUG: data_coding: 0 = 0x00000000
2017-09-26 12:04:08 [15922] [6] DEBUG: sm_default_msg_id: 0 = 0x00000000
2017-09-26 12:04:08 [15922] [6] DEBUG: sm_length: 23 = 0x00000017
2017-09-26 12:04:08 [15922] [6] DEBUG: short_message:
2017-09-26 12:04:08 [15922] [6] DEBUG:   Octet string at 0x7f227400c460:
2017-09-26 12:04:08 [15922] [6] DEBUG:     len: 23
2017-09-26 12:04:08 [15922] [6] DEBUG:     size: 24
2017-09-26 12:04:08 [15922] [6] DEBUG:     immutable: 0
2017-09-26 12:04:08 [15922] [6] DEBUG:     data: 44 <14 bytes> 73
2017-09-26 12:04:08 [15922] [6] DEBUG:     data: 74 <5 bytes> 39
2017-09-26 12:04:08 [15922] [6] DEBUG:   Octet string dump ends.
2017-09-26 12:04:08 [15922] [6] DEBUG: SMPP PDU dump ends.
2017-09-26 12:04:08 [15922] [6] DEBUG: SMPP[default_smsc]: throughput (1.00,5.00)
...

```

– Example link enquiry:

```

...
2017-09-26 12:13:38 [15922] [6] DEBUG: SMPP[default_smsc]: throughput (0.00,5.00)
2017-09-26 12:13:38 [15922] [6] DEBUG: SMPP[default_smsc]: Got PDU:
2017-09-26 12:13:38 [15922] [6] DEBUG: SMPP PDU 0x7f2274020790 dump:
2017-09-26 12:13:38 [15922] [6] DEBUG:   type_name: enquire_link
2017-09-26 12:13:38 [15922] [6] DEBUG:   command_id: 21 = 0x00000015
2017-09-26 12:13:38 [15922] [6] DEBUG:   command_status: 0 = 0x00000000
2017-09-26 12:13:38 [15922] [6] DEBUG:   sequence_number: 90764 = 0x0001628c
2017-09-26 12:13:38 [15922] [6] DEBUG: SMPP PDU dump ends.
2017-09-26 12:13:38 [15922] [6] DEBUG: SMPP[default_smsc]: Sending PDU:
2017-09-26 12:13:38 [15922] [6] DEBUG: SMPP PDU 0x7f2274025070 dump:
2017-09-26 12:13:38 [15922] [6] DEBUG:   type_name: enquire_link_resp
2017-09-26 12:13:38 [15922] [6] DEBUG:   command_id: 2147483669 = 0x80000015
2017-09-26 12:13:38 [15922] [6] DEBUG:   command_status: 0 = 0x00000000
2017-09-26 12:13:38 [15922] [6] DEBUG:   sequence_number: 90764 = 0x0001628c

```

```
2017-09-26 12:13:38 [15922] [6] DEBUG: SMPP PDU dump ends.
2017-09-26 12:13:38 [15922] [6] DEBUG: SMPP[default_smsc]: throughput (0.00,5.00)
...
```

7.27.2.2 SMS Box (PRX node of NGCP)

On the PRX node you can see a **process** named "**smsbox**". This process has a **listening port** assigned to it: 13002, that is the communication port towards the *Bearer Box* component running on LB nodes.

The *ngcp-service* tool also shows the *smsbox* process in its summary information:

```
$ ngcp-service summary
Ok Service                               Managed   Started   Status
--  -----
...
kannel-smsbox                           managed   by-ha     active
...
```

The following log files can provide information about the operation of *SMS Box*:

- sent and received messages using the API of WEB node: `/var/log/kannel/smsbox.log`

Note

Sent and received message examples shown here do not contain the full phone number and content for confidentiality reason.

– Example sent message:

```
...
2017-09-26 12:16:42 [22763] [2] DEBUG: HTTP: Creating HTTPClient for '192.168.1.2'.
2017-09-26 12:16:42 [22763] [2] DEBUG: HTTP: Created HTTPClient area 0x7f5dcc000ad0.
2017-09-26 12:16:42 [22763] [3] INFO: smsbox: Got HTTP request </cgi-bin/sendsms> from ↔
<192.168.1.3>
2017-09-26 12:16:42 [22763] [3] INFO: sendsms used by <sipwise>
2017-09-26 12:16:42 [22763] [3] INFO: sendsms sender:<sipwise:43668.....> ↔
(192.168.1.3) to:<43676.....> msg:<...>
2017-09-26 12:16:42 [22763] [3] DEBUG: Stored UUID ab95eb45-1ec0-4932-9863-1a95609a025f
2017-09-26 12:16:42 [22763] [3] DEBUG: message length 52, sending 1 messages
2017-09-26 12:16:42 [22763] [3] DEBUG: Status: 202 Answer: <Sent.>
2017-09-26 12:16:42 [22763] [3] DEBUG: Delayed reply - wait for bearerbox
2017-09-26 12:16:42 [22763] [0] DEBUG: Got ACK (0) of ab95eb45-1ec0-4932-9863-1 ↔
a95609a025f
2017-09-26 12:16:42 [22763] [0] DEBUG: HTTP: Destroying HTTPClient area 0x7f5dcc000ad0.
2017-09-26 12:16:42 [22763] [0] DEBUG: HTTP: Destroying HTTPClient for '192.168.1.3'.
```

...

– Example received message:

...

```

2017-09-26 11:59:45 [22763] [5] INFO: Starting to service <...message content...> from ←
  <+43676-----> to <+43668----->
2017-09-26 11:59:45 [22763] [10] DEBUG: Queue contains 0 pending requests.
2017-09-26 11:59:45 [22763] [10] DEBUG: HTTPS URL; Using SSL for the connection
2017-09-26 11:59:45 [22763] [10] DEBUG: Parsing URL `https://192.168.1.2:1443/ ←
  internalsms/receive?auth_token=fNLosMgwdNURKvEfFMm9
&timestamp=2017-09-26+09:59:45&from=%2B43676-----&to=%2B43668-----&charset=UTF-8& ←
  coding=0&text=...':
2017-09-26 11:59:45 [22763] [10] DEBUG:   Scheme: https://
2017-09-26 11:59:45 [22763] [10] DEBUG:   Host: 192.168.1.2
2017-09-26 11:59:45 [22763] [10] DEBUG:   Port: 1443
2017-09-26 11:59:45 [22763] [10] DEBUG:   Username: (null)
2017-09-26 11:59:45 [22763] [10] DEBUG:   Password: (null)
2017-09-26 11:59:45 [22763] [10] DEBUG:   Path: /internalsms/receive
2017-09-26 11:59:45 [22763] [10] DEBUG:   Query: auth_token=fNLosMgwdNURKvEfFMm9& ←
  timestamp=2017-09-26+09:59:45&from=%2B43676-----
&to=%2B43668-----&charset=UTF-8&coding=0&text=...
2017-09-26 11:59:45 [22763] [10] DEBUG:   Fragment: (null)
2017-09-26 11:59:45 [22763] [10] DEBUG: Connecting nonblocking to <192.168.1.2>
2017-09-26 11:59:45 [22763] [10] DEBUG: HTTP: Opening connection to '192.168.1.2:1443' ( ←
  fd=31).
2017-09-26 11:59:45 [22763] [10] DEBUG: Socket connecting
2017-09-26 11:59:45 [22763] [9] DEBUG: Get info about connecting socket
2017-09-26 11:59:45 [22763] [9] DEBUG: HTTP: Sending request:
2017-09-26 11:59:45 [22763] [9] DEBUG: Octet string at 0x7f5dbc00f470:
2017-09-26 11:59:45 [22763] [9] DEBUG:   len: 382
2017-09-26 11:59:45 [22763] [9] DEBUG:   size: 1024
2017-09-26 11:59:45 [22763] [9] DEBUG:   immutable: 0
2017-09-26 11:59:45 [22763] [9] DEBUG:   data: 47 45 54 20 2f 69 6e 74 65 72 6e 61 6c 73 ←
  6d 73   GET /internalsms
2017-09-26 11:59:45 [22763] [9] DEBUG:   data: 2f 72 65 63 65 69 76 65 3f 61 75 74 68 5f ←
  74 6f   /receive?auth_to
2017-09-26 11:59:45 [22763] [9] DEBUG:   data: 6b 65 6e 3d ... ←
  ken=
  ... 20 48 54 54 50 2f 31 2e 31 ←
  0d 0a   HTTP/1.1..
2017-09-26 11:59:45 [22763] [9] DEBUG:   data: 43 6f 6e 6e 65 63 74 69 6f 6e 3a 20 6b 65 ←
  65 70   Connection: keep
2017-09-26 11:59:45 [22763] [9] DEBUG:   data: 2d 61 6c 69 76 65 0d 0a 55 73 65 72 2d 41 ←
  67 65   -alive..User-Age
2017-09-26 11:59:45 [22763] [9] DEBUG:   data: 6e 74 3a 20 4b 61 6e 6e 65 6c 2f 31 2e 34 ←
  2e 34   nt: Kannel/1.4.4

```

```
2017-09-26 11:59:45 [22763] [9] DEBUG: data: 0d 0a 48 6f 73 74 3a 20 31 39 32 2e 31 36 ←
      38 2e ..Host: 192.168.
2017-09-26 11:59:45 [22763] [9] DEBUG: data: 31 2e 32 3a 31 34 34 33 0d 0a 0d 0a ←
      1.2:1443....
2017-09-26 11:59:45 [22763] [9] DEBUG: Octet string dump ends.
2017-09-26 11:59:45 [22763] [9] DEBUG: HTTP: Status line: <HTTP/1.1 200 OK>
2017-09-26 11:59:45 [22763] [9] DEBUG: HTTP: Received response:
2017-09-26 11:59:45 [22763] [9] DEBUG: Octet string at 0x7f5dbc006970:
2017-09-26 11:59:45 [22763] [9] DEBUG: len: 333
2017-09-26 11:59:45 [22763] [9] DEBUG: size: 1024
2017-09-26 11:59:45 [22763] [9] DEBUG: immutable: 0
2017-09-26 11:59:45 [22763] [9] DEBUG: data: 53 65 72 76 65 72 3a 20 6e 67 69 6e 78 0d ←
      0a 44 Server: nginx..D
2017-09-26 11:59:45 [22763] [9] DEBUG: data: 61 74 65 3a 20 54 75 65 2c 20 32 36 20 53 ←
      65 70 ate: Tue, 26 Sep
2017-09-26 11:59:45 [22763] [9] DEBUG: data: 20 32 30 31 37 20 30 39 3a 35 39 3a 34 35 ←
      20 47 2017 09:59:45 G
2017-09-26 11:59:45 [22763] [9] DEBUG: data: 4d 54 0d 0a 43 6f 6e 74 65 6e 74 2d 54 79 ←
      70 65 MT..Content-Type
2017-09-26 11:59:45 [22763] [9] DEBUG: data: 3a 20 74 65 78 74 2f 68 74 6d 6c 3b 20 63 ←
      68 61 : text/html; cha
2017-09-26 11:59:45 [22763] [9] DEBUG: data: 72 73 65 74 3d 75 74 66 2d 38 0d 0a 43 6f ←
      6e 74 rset=utf-8..Cont
2017-09-26 11:59:45 [22763] [9] DEBUG: data: 65 6e 74 2d 4c 65 6e 67 74 68 3a 20 30 0d ←
      0a 43 ent-Length: 0..C
2017-09-26 11:59:45 [22763] [9] DEBUG: data: 6f 6e 6e 65 63 74 69 6f 6e 3a 20 6b 65 65 ←
      70 2d onnection: keep-
2017-09-26 11:59:45 [22763] [9] DEBUG: data: 61 6c 69 76 65 0d 0a 53 65 74 2d 43 6f 6f ←
      6b 69 alive..Set-Cooki
2017-09-26 11:59:45 [22763] [9] DEBUG: data: 65 3a 20 6e 67 63 70 5f 70 61 6e 65 6c 5f ←
      73 65 e: ngcp_panel_se
2017-09-26 11:59:45 [22763] [9] DEBUG: data: 73 73 69 6f 6e 3d 34 35 30 32 64 64 66 65 ←
      31 62 ssion=4502ddfelb
2017-09-26 11:59:45 [22763] [9] DEBUG: data: 63 31 65 33 39 30 65 30 64 36 66 39 64 34 ←
      37 30 c1e390e0d6f9d470
2017-09-26 11:59:45 [22763] [9] DEBUG: data: 35 30 37 62 64 64 33 61 65 32 36 62 64 63 ←
      3b 20 507bdd3ae26bdc;
2017-09-26 11:59:45 [22763] [9] DEBUG: data: 70 61 74 68 3d 2f 3b 20 65 78 70 69 72 65 ←
      73 3d path=/; expires=
2017-09-26 11:59:45 [22763] [9] DEBUG: data: 54 75 65 2c 20 32 36 2d 53 65 70 2d 32 30 ←
      31 37 Tue, 26-Sep-2017
2017-09-26 11:59:45 [22763] [9] DEBUG: data: 20 31 30 3a 35 39 3a 34 35 20 47 4d 54 3b ←
      20 48 10:59:45 GMT; H
2017-09-26 11:59:45 [22763] [9] DEBUG: data: 74 74 70 4f 6e 6c 79 0d 0a 58 2d 43 61 74 ←
      61 6c ttpOnly..X-Catal
2017-09-26 11:59:45 [22763] [9] DEBUG: data: 79 73 74 3a 20 35 2e 39 30 30 37 35 0d 0a ←
      53 74 yst: 5.90075..St
2017-09-26 11:59:45 [22763] [9] DEBUG: data: 72 69 63 74 2d 54 72 61 6e 73 70 6f 72 74 ←
```

```

    2d 53    rict-Transport-S
2017-09-26 11:59:45 [22763] [9] DEBUG:   data: 65 63 75 72 69 74 79 3a 20 6d 61 78 2d 61 ↔
    67 65    ecurity: max-age
2017-09-26 11:59:45 [22763] [9] DEBUG:   data: 3d 31 35 37 36 38 30 30 30 0d 0a 0d 0a ↔
    =15768000....
2017-09-26 11:59:45 [22763] [9] DEBUG: Octet string dump ends.
2017-09-26 11:59:45 [22763] [6] WARNING: Tried to set Coding field, denied.
2017-09-26 11:59:45 [22763] [6] INFO: No reply sent, denied.
2017-09-26 11:59:55 [22763] [9] DEBUG: HTTP: Server closed connection, destroying it ↔
    <192.168.1.2:1443:1::><0x7f5db000b20><fd:31>.
...

```

- short log of sent/received messages: `/var/log/kannel/smsbox-access.log`

```

...
2017-09-26 12:39:18 SMS HTTP-request sender:+43680----- request: '' url: 'https ↔
    ://192.168.1.2:1443/internalsms/receive?
auth_token=fNLosMgwdNUrKvEfFMm9&timestamp=2017-09-26+10:39:18&from=%2B43680-----&to=%2 ↔
    B43668-----&charset=UTF-8&coding=0
&text=<...message content...>' reply: 200 '<< successful >>'
...
2017-09-26 12:41:54 send-SMS request added - sender:sipwise:43668----- 192.168.1.3 ↔
    target:43680----- request: '<...message content...>'
...

```

7.27.3 REST API

Handling of short messages from the user perspective happens with the help of NGCP's REST API. There is a dedicated resource: `https://<IP of WEB node>:1443/api/sms` that allows you to:

- **Get a list of sent and received messages.** This is achieved by sending a GET request on the `/api/sms` collection, as in the following example:

```

curl -i -X GET -H 'Connection: close' --cert NGCP-API-client-certificate.pem \
    --cacert ca-cert.pem 'https://example.org:1443/api/sms/?page=1&rows=10'

```

- **Retrieve an SM** (both sent and received). This is achieved by sending a GET request for a specific `/api/sms/id` item, as in the following example:

```

curl -i -X GET -H 'Connection: close' --cert NGCP-API-client-certificate.pem \
    --cacert ca-cert.pem 'https://example.org:1443/api/sms/1'

```

- **Send a new message** from a local subscriber. This is achieved by sending a POST request for the `/api/sms` collection, as in the following example:

```
curl -i -X POST -H 'Connection: close' -H 'Content-Type: application/json' \
  --cert NGCP-API-client-certificate.pem --cacert ca-cert.pem \
  'https://example.org:1443/api/sms/' --data-binary '{"callee" : "43555666777", \
  "subscriber_id" : 4, "text" : "test"}'
```

As always, the full documentation of the REST API resources is available on the admin web interface of NGCP: `https://<IP of WEB node>:1443/api/#sms`

7.28 Time sets management

7.28.1 Time sets specifications and data description

The Sipwise C5 provides administrative WEB and API interface to manage time sets.

Supported fields, input and output format are based on **iCalendar EVENT** specification.

Not all iCalendar and EVENT properties are supported, but those that are used for time points and periods definition or stated mandatory by specification:

- CALENDAR supported properties:

- NAME

- EVENT supported properties:

- SUMMARY

- DTSTART

- DTEND

- RRULE

Important to mention that current implementation does not support these EVENT properties:

- DTSTAMP (UID is used in generated calendar ics file, both UID and DTSTAMP are ignored during uploading calendar file);
- DURATION (DTEND is used);
- RDATE
- EXDATE
- PRIORITY

Main EVENT property, that is used for time points and periods definition is RRULE. Current time sets implementation supports all properties described in the [RRULE specification](#) except WKST.

Default value for week start is MO (Monday).

7.28.2 Web interface for the time sets

Time sets management section is provided in two variants. One is main time sets management section and other is a chapter on reseller details page. Variants have minor differences. Functionality will be explained using time sets dedicated interface. Differences will be explained below.

Time set can be created using creation form. On time sets management interface press button "Create Time Set Entry":

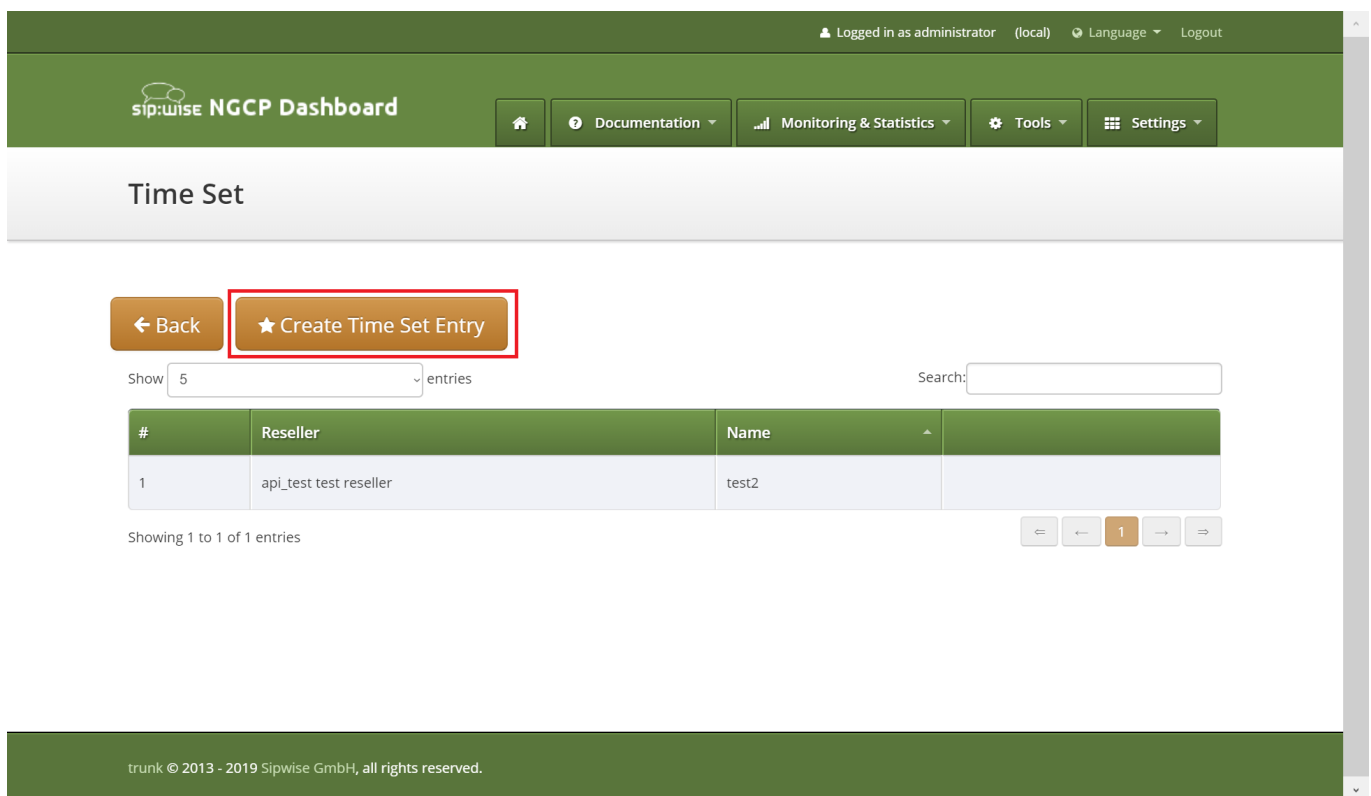

The screenshot shows the Sipwise NGCP Dashboard interface. At the top, there is a navigation bar with the logo and the text "sip:wise NGCP Dashboard". Below the logo, there are several menu items: Home, Documentation, Monitoring & Statistics, Tools, and Settings. The main content area is titled "Time Set".

In the "Time Set" section, there are two buttons: "← Back" and "★ Create Time Set Entry". The "Create Time Set Entry" button is highlighted with a red box. Below the buttons, there is a "Show" dropdown menu set to "5" and a "Search:" input field. Below the search field, there is a table with the following data:

#	Reseller	Name
1	api_test test reseller	test2

Below the table, it says "Showing 1 to 1 of 1 entries". There are also pagination controls showing "1" in a highlighted box.

At the bottom of the dashboard, there is a footer with the text "trunk © 2013 - 2019 Sipwise GmbH, all rights reserved."

"Reseller" field is mandatory.

"Name" field should be defined, if iCalendar (ics) file is not going to be uploaded or file doesn't have NAME property for the CALENDAR entry.

If both NAME in the uploaded iCalendar (ics) file and form field "Name" aren't empty then value from the form field will be taken.

Created time set can be modified:

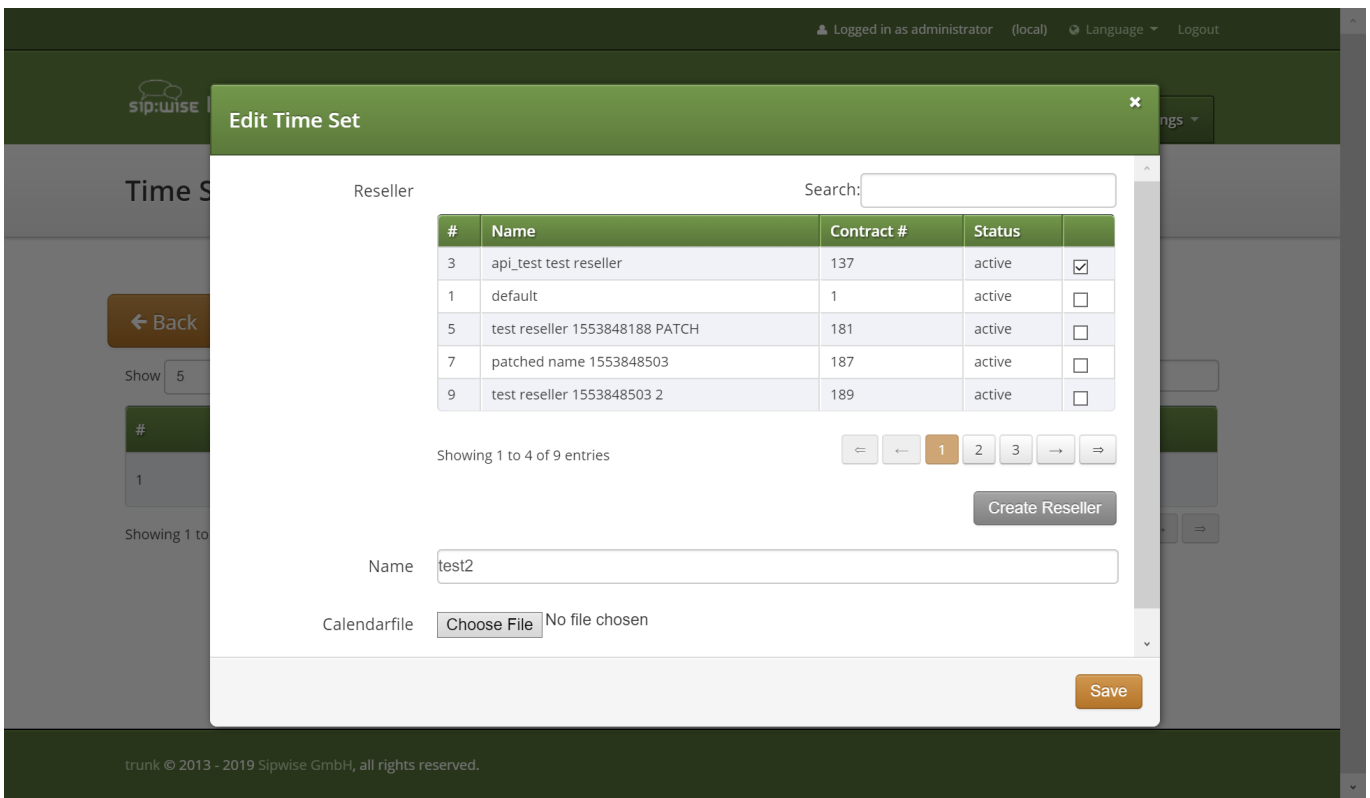
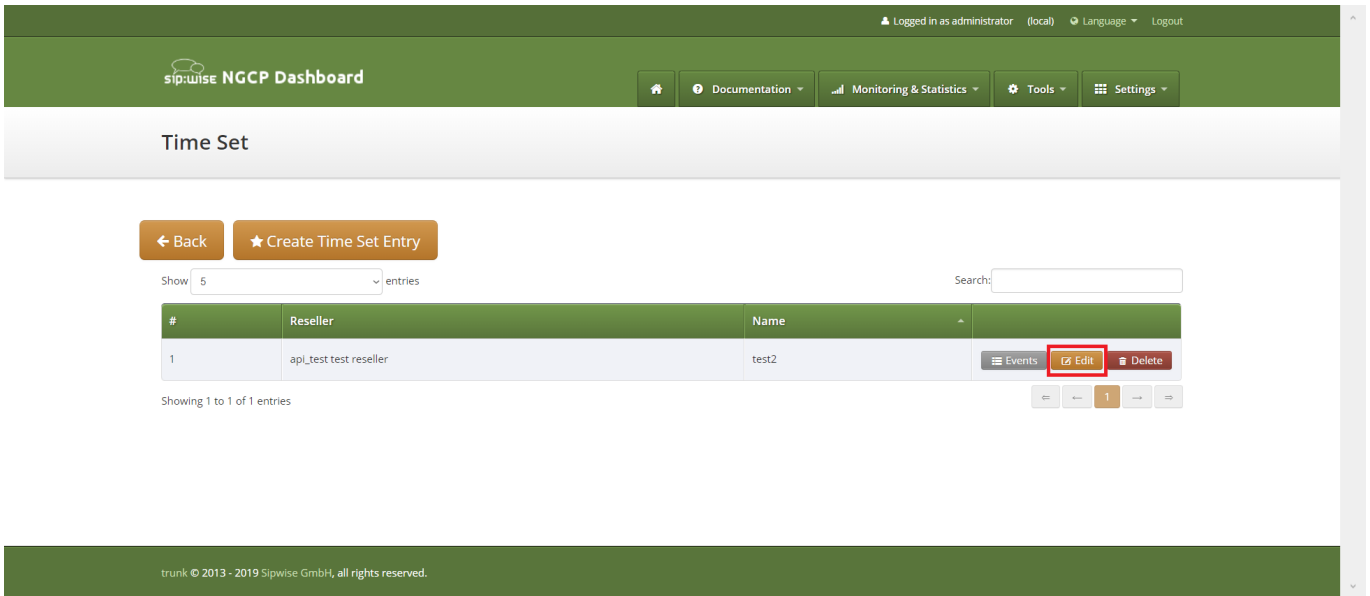

or deleted:

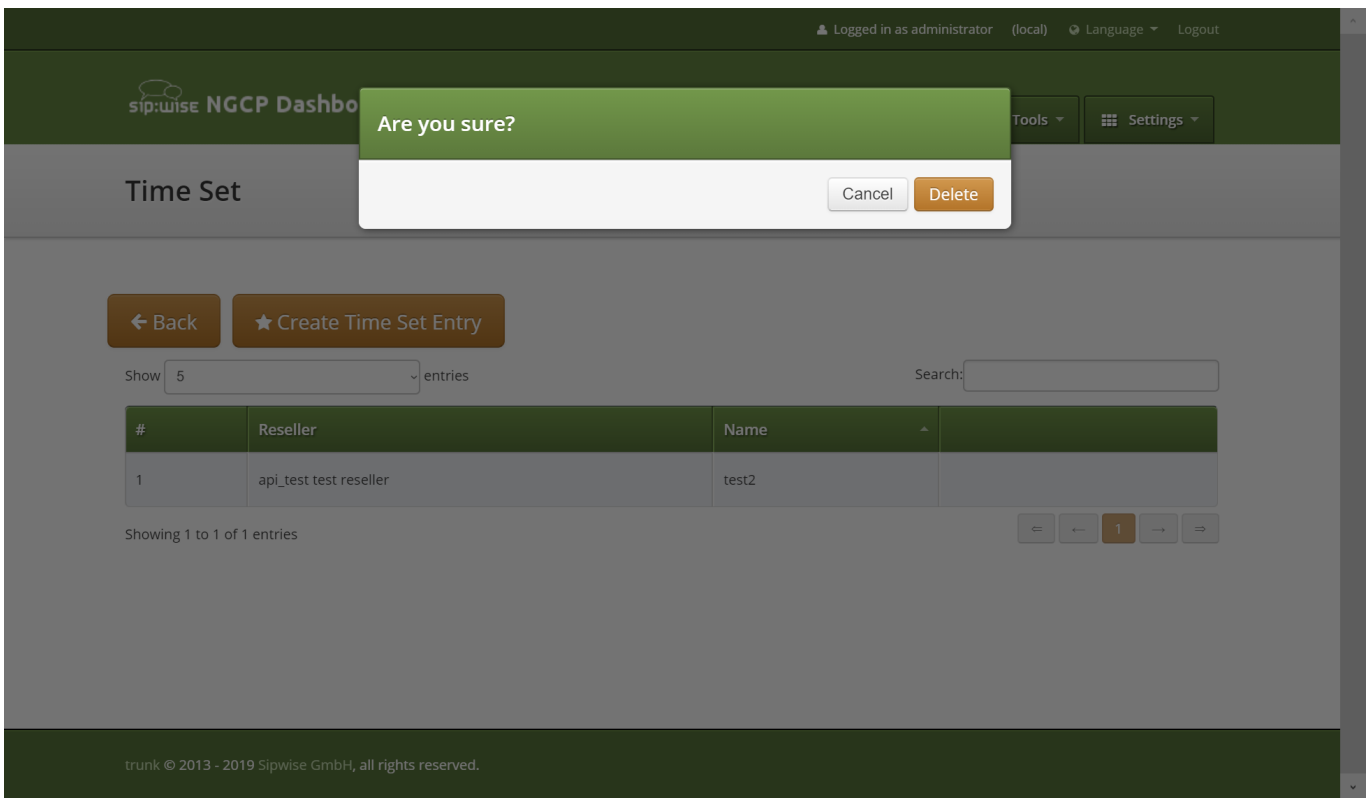
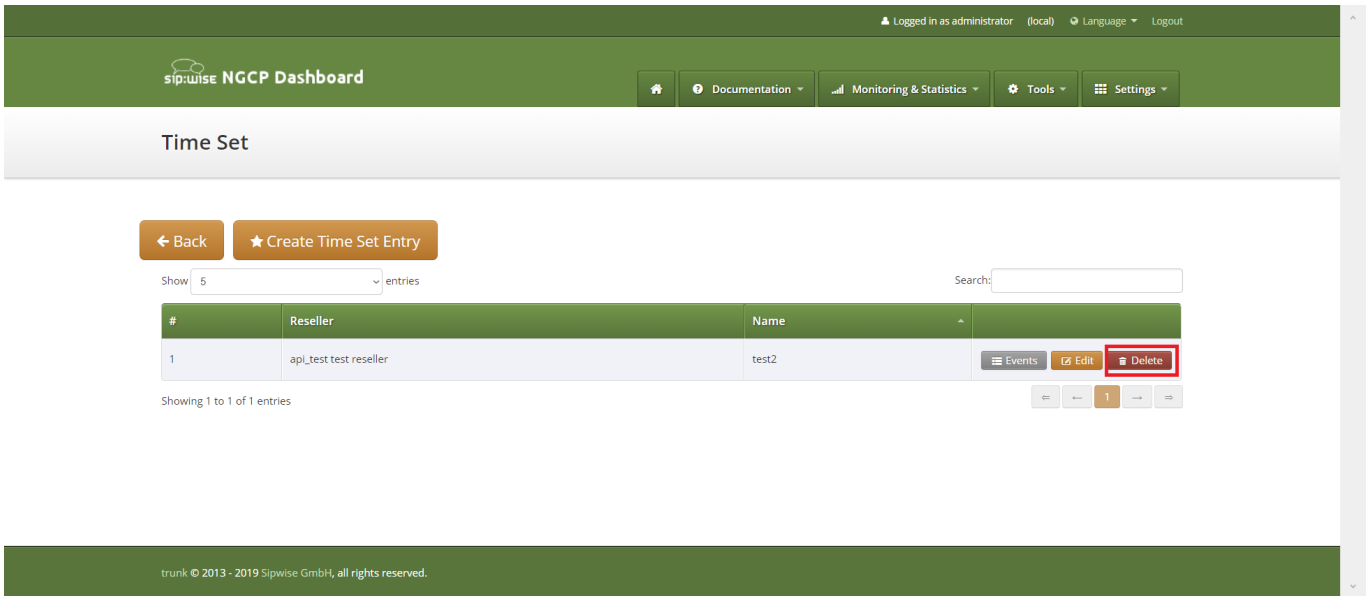

Note

If calendar ics file will be uploaded to edit time set, all presented events will be deleted and events from the uploaded file will be added after it.

7.28.3 Web interface for the time set events

Time set can contain set of events. Each time set event will be used to generate CALENDAR EVENT entry in the generated iCalendar file. So all fields in the time set event forms represent properties of the iCalendar EVENT component.

To manage time set events press "Events" button against proper time set.

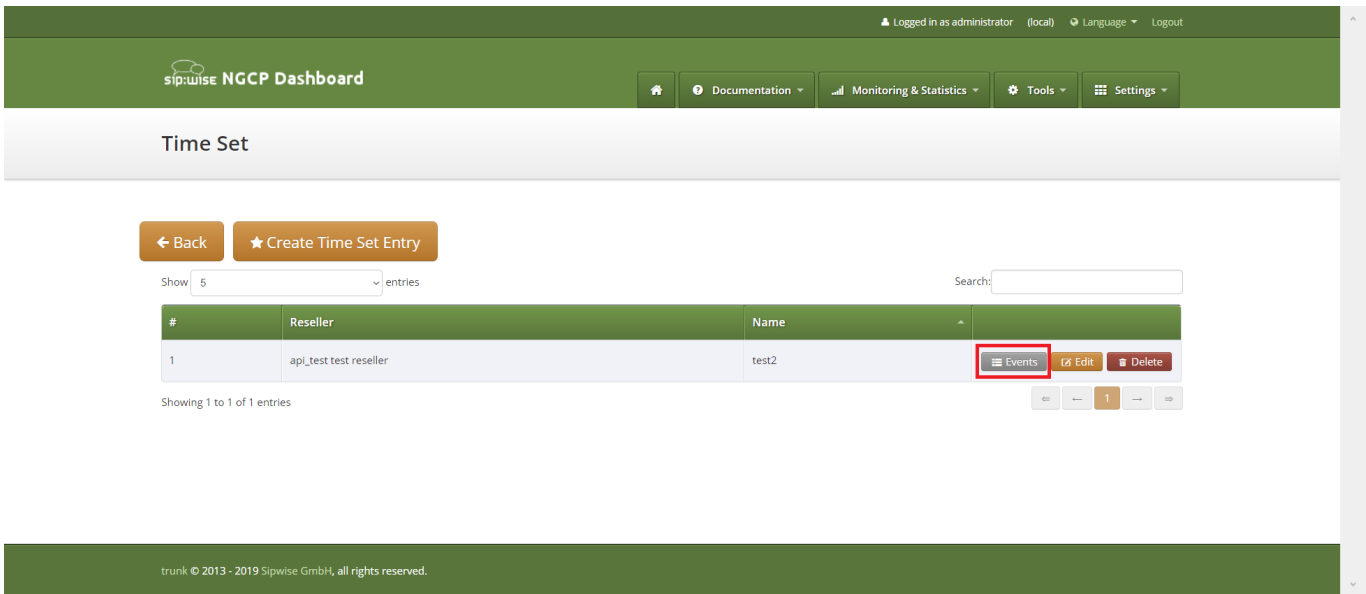

Events management section will appear:

To create event press "Create Event" button.

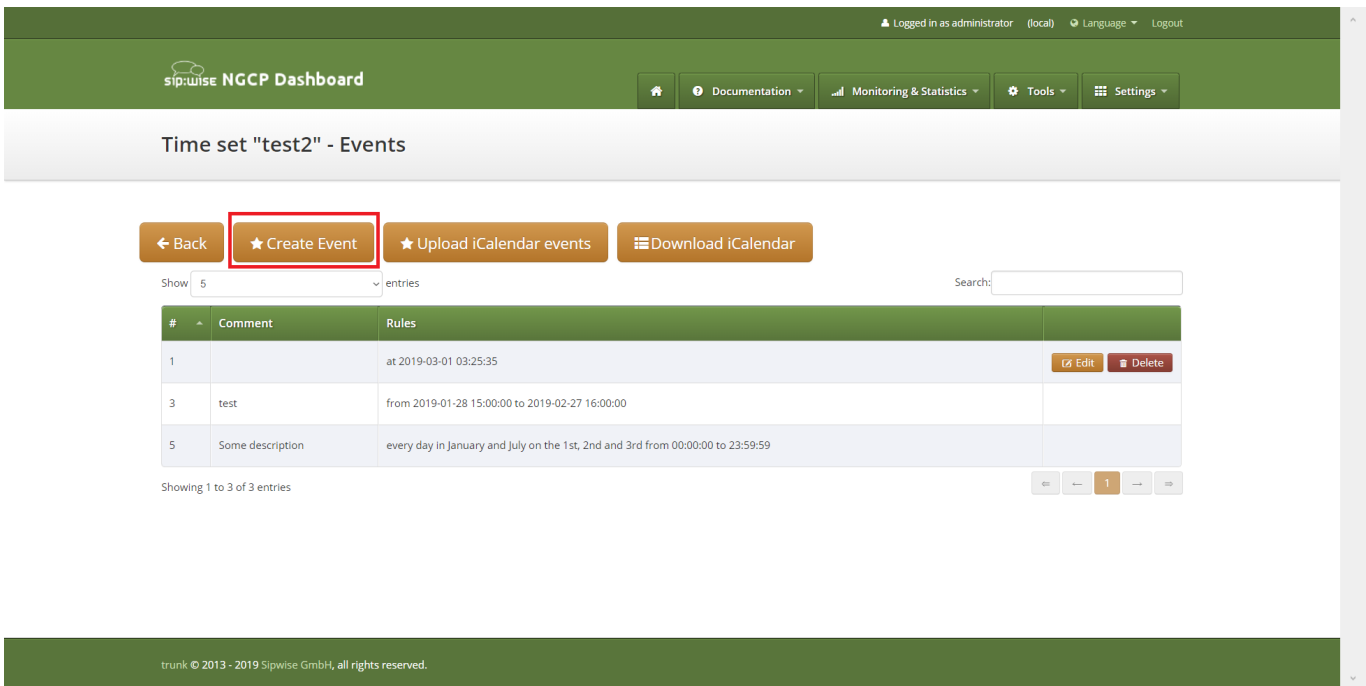

Form to create event will be shown:

The screenshot displays the Sipwise NCCP Dashboard interface. A modal window titled "Create Time Set Event" is open, allowing the user to create a new event. The form includes the following fields and controls:

- Comment:** A text input field.
- Start:** A section containing a "Date" field (set to 2019-04-01) and a "Time" field (set to 00:00:00).
- Stop:** A button labeled "Set" used to specify the stop datetime.
- Repeat:** A dropdown menu currently set to "None (run once)".
- Save:** A button at the bottom right of the modal to save the event.

The background shows a table of existing time set events. The table has columns for "#", "test", and "from 2019-01-28 15:00:00 to 2019-02-27 16:00:00". The table shows 2 entries, with the first entry visible.

Showing 1 to 2 of 2 entries

trunk © 2013 - 2019 Sipwise GmbH, all rights reserved.

7.28.3.1 Time set event form fields explanation

"Start" field reflects DTSTART property of the EVENT. "Start" is mandatory and by default is set to the start of the current day. "Start" value format is datetime.

"Stop" field reflects DTEND property of the EVENT. For the events within recurrence "Stop" will define duration of each iteration.

To specify "Stop" datetime, press button "Set".

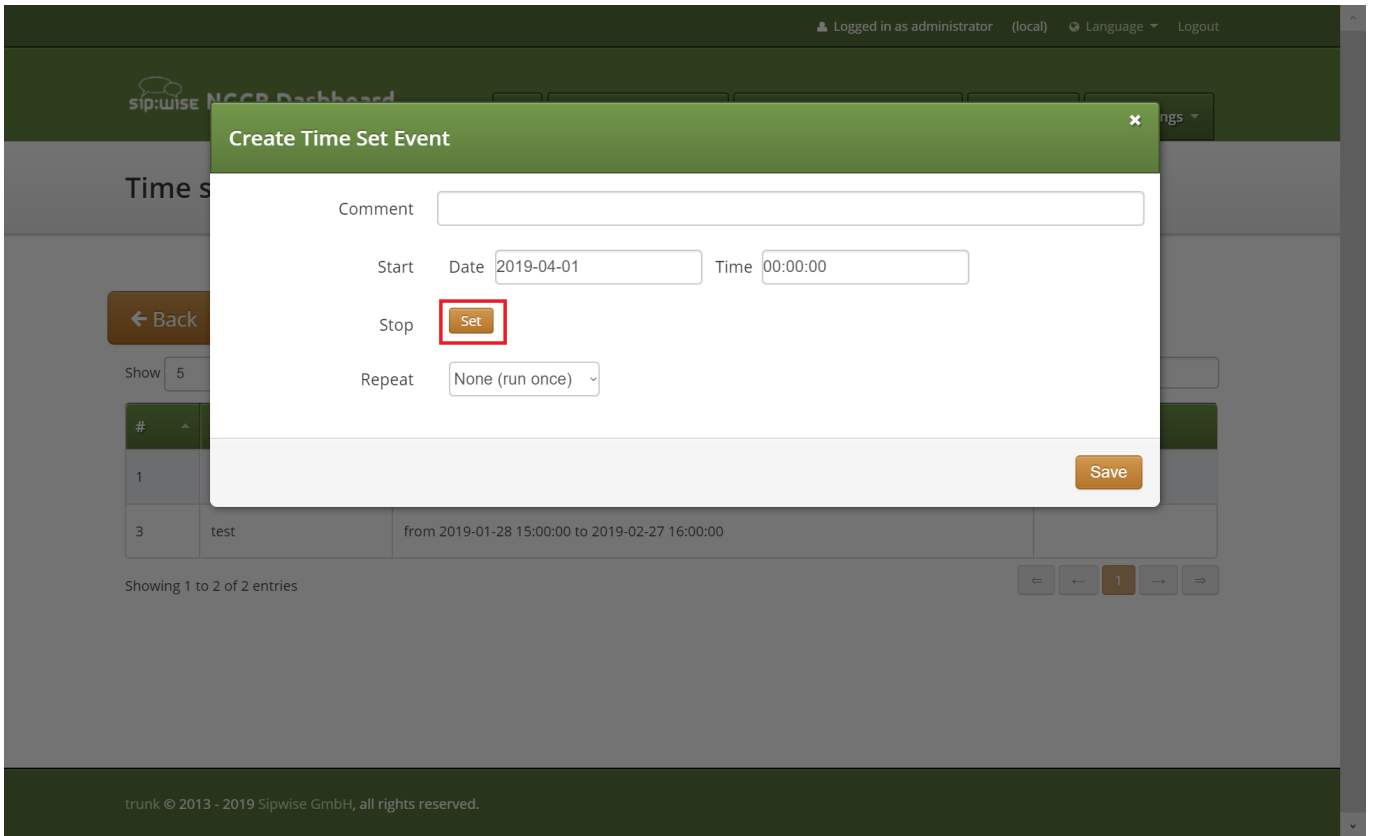

Fields to enter DTEND date and time will appear:

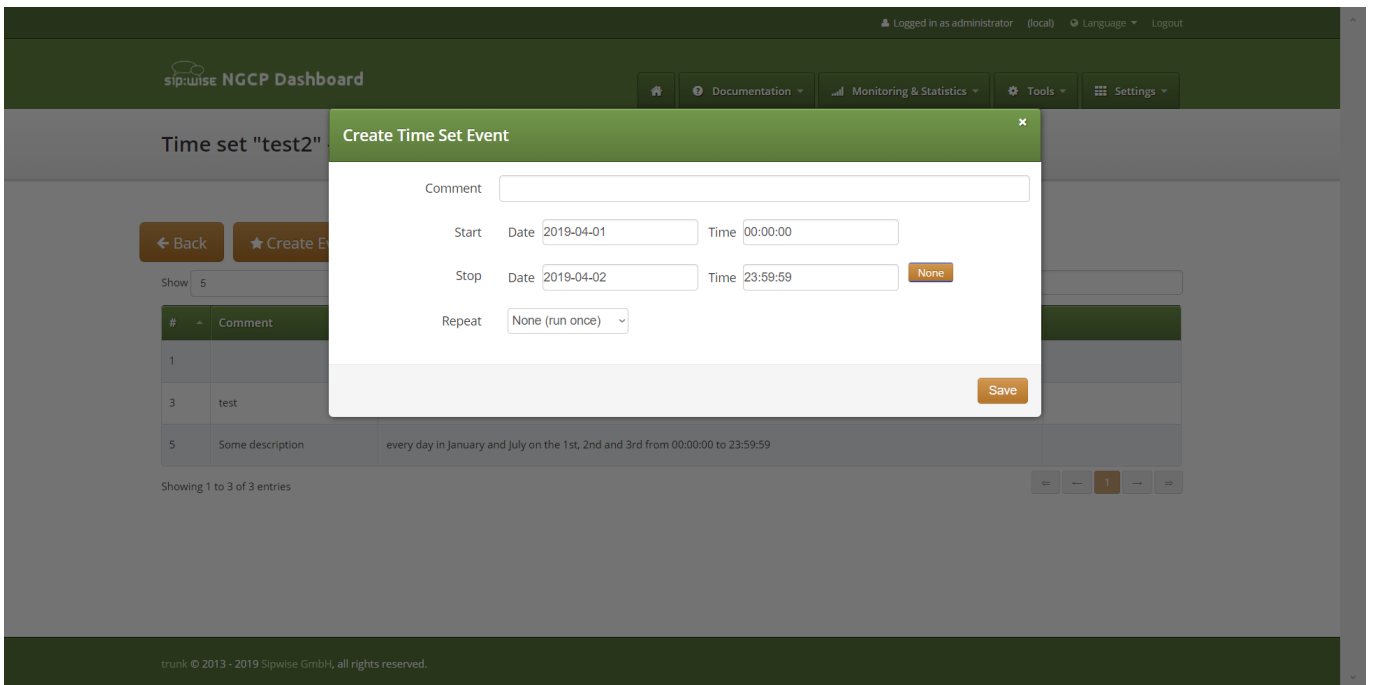

To return "Stop" field to the empty value press button "None". Value in the form fields will be preserved, but newly created EVENT will have empty DTEND property.

Other fields in the form are optional. Most of them aren't visible by default and will be shown if requested by user or required by

data into other fields.

RRULE property of the EVENT is a recurrence rule and defines set of the iterations for the EVENT.

To customize recurrence rule for the EVENT select proper repetition unit for the "Repeat" form field. Input field for the recurrence interval will appear left to the frequency select.

According to the selected unit, FREQ property of the EVENT RRULE will be set to one of the: SECONDLY, MINUTELY, HOURLY, DAYLY, WEEKLY, MONTHLY, YEARLY.

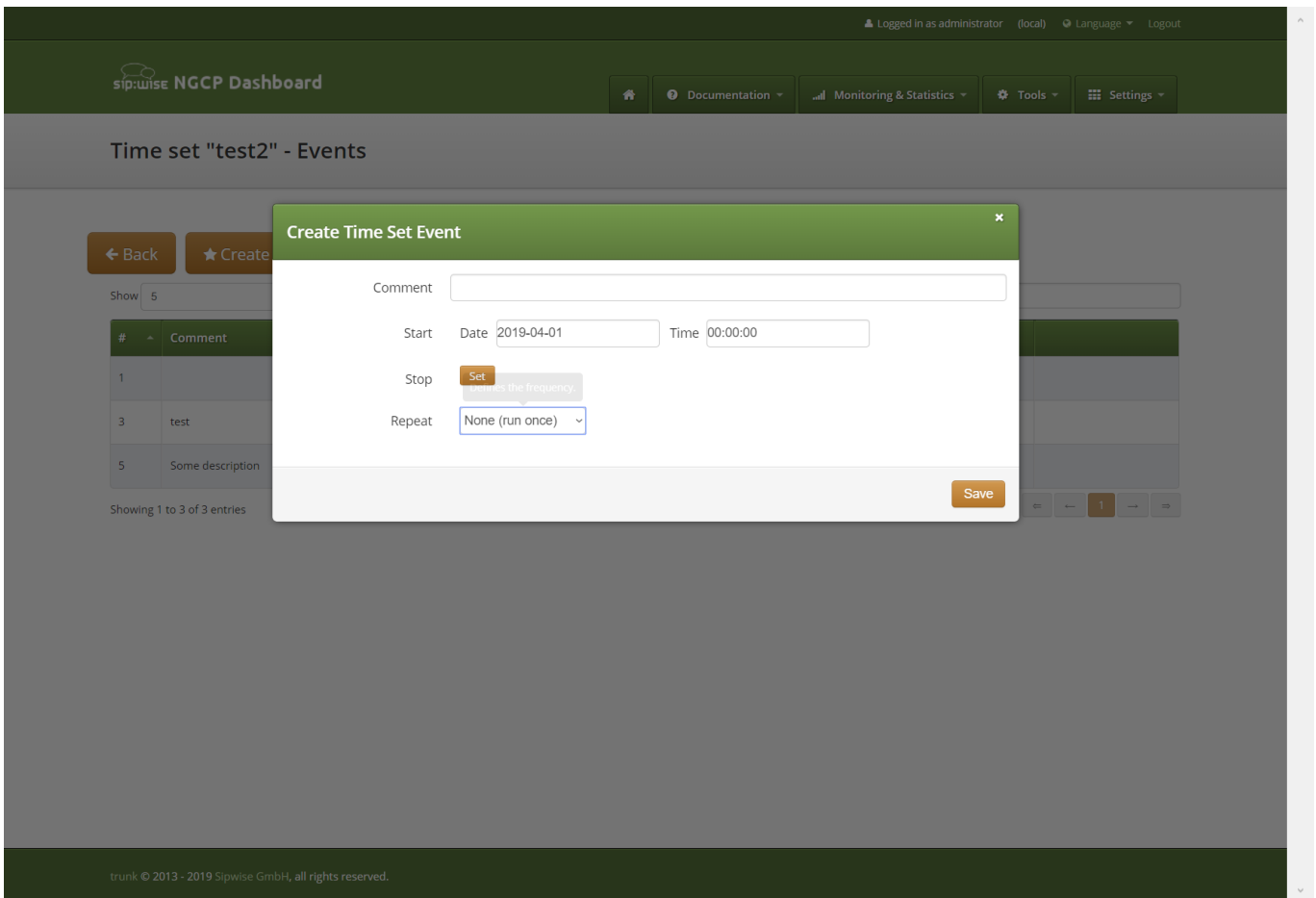

The screenshot displays the Sipwise NGCP Dashboard interface. At the top, it shows the user is logged in as an administrator. The main navigation bar includes links for Documentation, Monitoring & Statistics, Tools, and Settings. The current page is titled "Time set 'test2' - Events". A modal dialog box titled "Create Time Set Event" is open, allowing the user to configure a new event. The dialog contains the following fields:

- Comment:** A text input field.
- Start:** A date field set to "2019-04-01" and a time field set to "00:00:00".
- Stop:** A dropdown menu with the option "Set as the frequency".
- Repeat:** A dropdown menu currently set to "None (run once)".

A "Save" button is located at the bottom right of the dialog. In the background, a table of events is visible with columns for "#", "Comment", and "Showing 1 to 3 of 3 entries".

To specify end of the EVENT iterations, select "Series stop" value. For the "at date" option will be shown input for the date and time that will define UNTIL property of the EVENT RRULE.

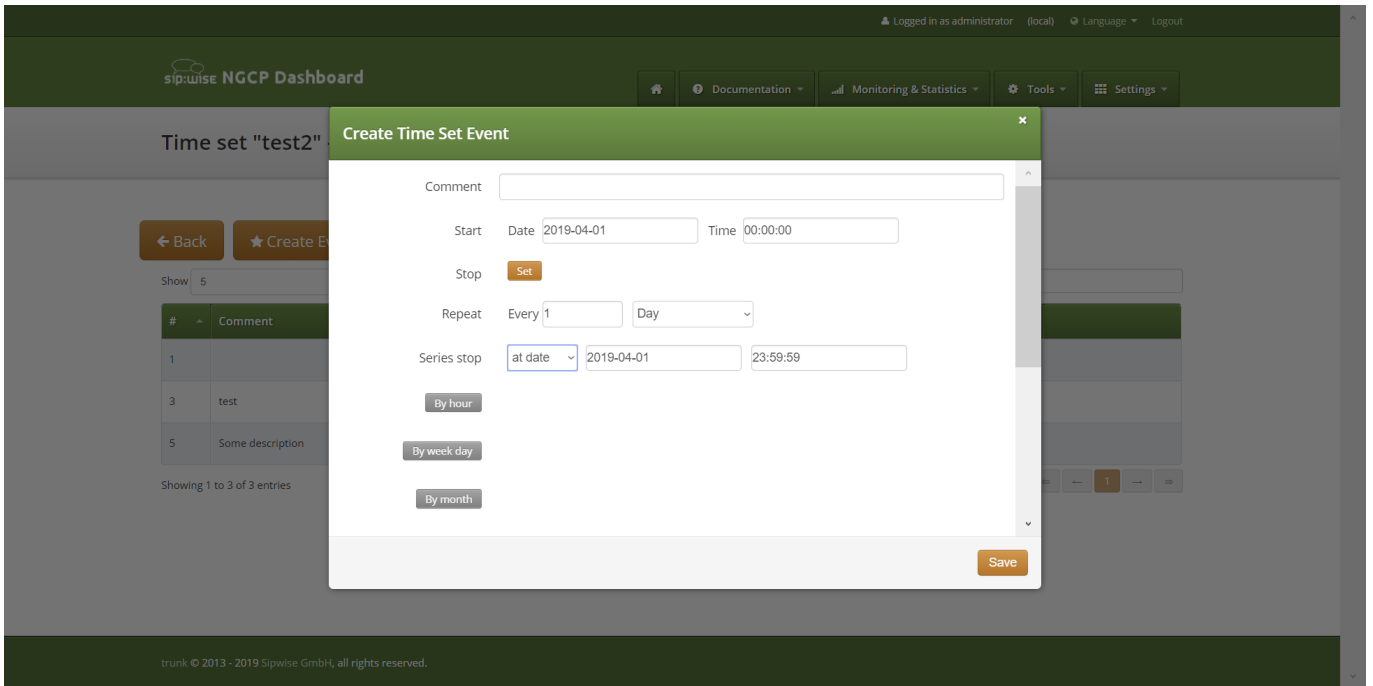

"after" option, respectively, will put entered value to the COUNT property of the EVENT RRULE.

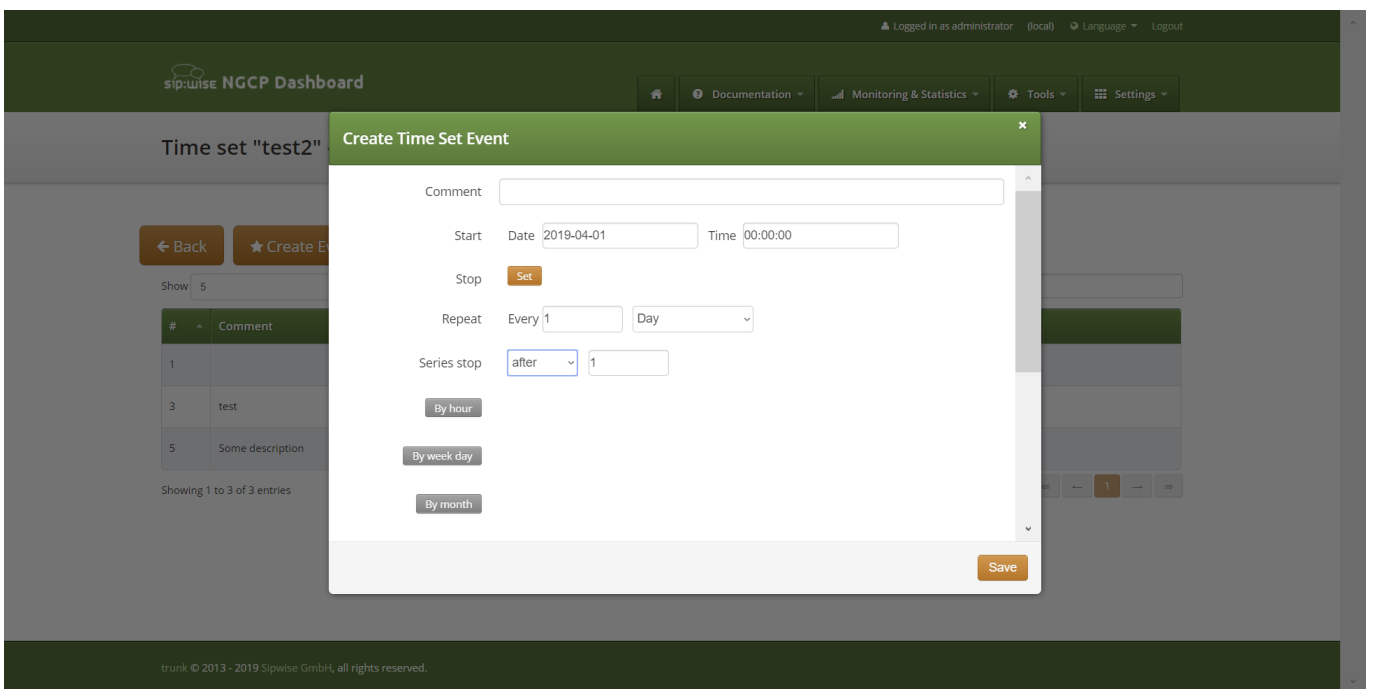

Form fields "By hour", "By week day", "By month", "By month day", "By set position", "By week number", "By year day", "By second" and "By minute" aren't shown by default. To enter value to any of these fields press according button on the left. Button with field name is grayed off when corresponding EVENT property is empty.

The screenshot shows the 'Create Time Set Event' dialog box in the Sipwise NGCP Dashboard. The dialog box is open over a table of events. The dialog has the following fields and controls:

- Comment:
- Start Date: Time:
- Stop: (Defines the frequency)
- Repeat: Every
- Series stop:
- Buttons: , ,
- Save:

The background shows a table of events with columns '#', 'Comment', and 'Series stop'. The table contains three entries:

#	Comment	Series stop
1		
3	test	
5	Some description	

Showing 1 to 3 of 3 entries

When gray button with field name is pressed, field input control appears on the right. In the same time button with field name becomes orange, indicating that field value will be saved for the EVENT.

Fields with checkboxes controls have auxiliary button "Invert selection". When button "Invert selection" is pressed currently empty checkboxes become selected and currently selected checkboxes become empty.

trunk © 2013 - 2019 Sipwise GmbH, all rights reserved.

When form data will be saved, checkboxes values will be saved as coma separated numbers.

BYxxx RRULE properties expand or limit behavior of the FREQ according to the table in the [RRULE specification](#).

Field "By week day" has two variants of the input: checkbox for each week day and text input. Text input can be used, if "By week day" value is more complex than just list of week days, separated by coma, for example for FREQ MONTHLY value "2TH,-3FR" in the "By week day" will mean second Thursday from the month start and third Friday from the month end in every month. Such value can't be presented as checkboxes selection.

Fields "By set position" and "By year day" are text inputs. Value format for these fields is set of the [+/-]NUMBER values, separated by comma.

For the "By year day" minus sign in front of year day number means that this day should be taken by number from the end of the year.

For the "By set position" minus sign in front of the position of the iteration means that the iteration should be taken by number from the end of the generated iterations sequence.

After new event created, event will appear in time set event list. It will have column with rrule text description, buttons to request event edit form or event deletion.

In events list section all events can be redefined uploading ics iCalendar file:

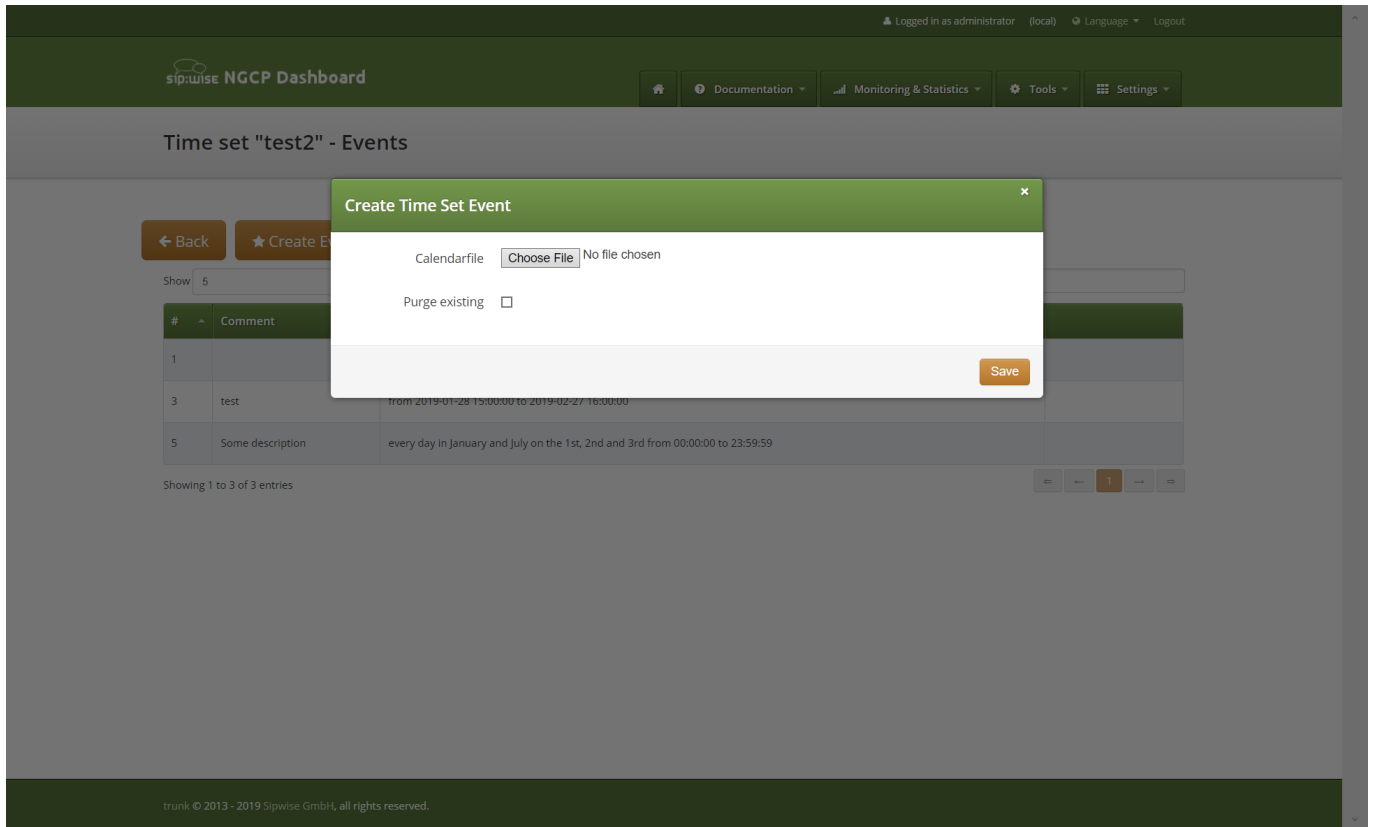

If "Purge existing" option is selected, all existing time set events will be removed before creation of the events from the uploaded file.

To download iCalendar ics file of the time set, press "Download iCalendar".

7.28.4 Web interface for time set related to reseller

Reseller details page provides list of the time sets connected to the reseller and allows create, edit, delete and download time set and has link to the time set events section:

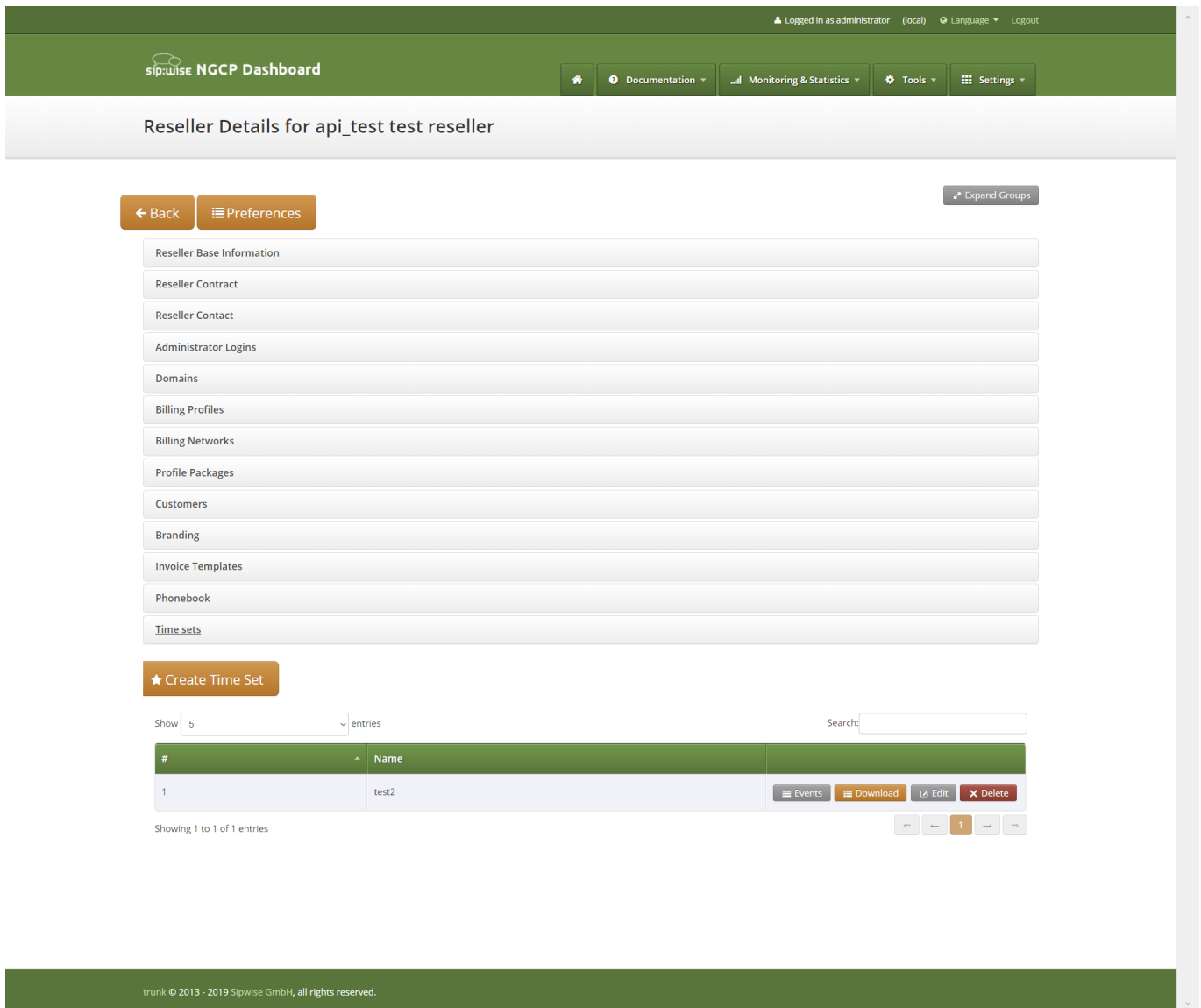

Logged in as administrator (local) Language Logout

sipwise NGCP Dashboard

Documentation Monitoring & Statistics Tools Settings

Reseller Details for api_test test reseller

Back Preferences Expand Groups

- Reseller Base Information
- Reseller Contract
- Reseller Contact
- Administrator Logins
- Domains
- Billing Profiles
- Billing Networks
- Profile Packages
- Customers
- Branding
- Invoice Templates
- Phonebook
- Time sets

★ Create Time Set

Show 5 entries Search:

#	Name	Events	Download	Edit	Delete
1	test2				

Showing 1 to 1 of 1 entries

trunk © 2013 - 2019 Sipwise GmbH, all rights reserved.

In difference to the main time set interface, iCalendar ics file for the time set can be downloaded from the time set list pressing "Download" button.

Creation form doesn't have "Reseller" field and is processed in context of the current reseller.

7.28.5 REST API

Time sets management is possible using API REST entry point `/api/timesets/`.

Time sets API has possibility to get and return information both as "application/json" data and as "text/calendar" file.

To create time set with events full specification of the all fields in json format can be used:

```
curl --request POST --user administrator:administrator --header Prefer: return=representation --header Content-Type: application/json https://127.0.0.1:1443/api/timesets/ --data {"reseller": "api_test", "name": "api_test_timeset_name1", "times": [{"start": "1971-01-01 00:00:01", "until": "1997-01-01 00:00:01"}]}
```

```
23:59:59", "end": "2020-12-31 23:59:59"]}]}
```

Also time set and events can be uploaded as ics iCalendar file:

```
curl --request POST --user administrator:administrator --header Prefer: return=representation --header Content-Type: multipart/form-data https://127.0.0.1:1443/api/timesets/ --form json={"reseller_id":3, "name": "unique_name"} --form calendarfile=@/path/to/calendar.ics
```

Output of the GET request to the time set item can be text/calendar:

```
curl --request GET --user administrator:administrator --header Accept: text/calendar http://127.0.0.1:1443/api/timesets/12 > /path/to/download/calendar.ics
```

or application/json:

```
curl --request GET --user administrator:administrator --header Accept: application/json https://127.0.0.1:1443/api/timesets/12
```

By default API will send response in text/calendar format.

Output will be generated iCalendar including time set events:

```
curl --request GET --user administrator:administrator 'https://127.0.0.1:1443/api/timesets/12'
BEGIN:VCALENDAR
PRODID:-//Mozilla.org/NONSGML Mozilla Calendar V1.1//EN
NAME:api_test_timeset_name2
VERSION:2.0

BEGIN:VEVENT
UID:sipwise19@sipwise15
SUMMARY:unique_name event 19
DTSTART:19710101T000001
DTEND:20201231T235959
END:VEVENT
END:VCALENDAR+
```

8 Customer Self-Care Interface and Menus

There are two ways for end users to maintain their subscriber settings: via the *Customer Self-Care Web Interface* and via *Vertical Service Codes* using their SIP phones.

8.1 The Customer Self-Care Web Interface

The Sipwise C5 provides a web panel for end users (CSC panel) to maintain their subscriber accounts, which is running on *https://<ngcp-ip>*. Every subscriber can log in there, change subscriber feature settings, view their call lists, retrieve voicemail messages and trigger calls using the click-to-dial feature.

8.1.1 Login Procedure

To log into the CSC panel, the end user has to provide his full web username (e.g. *user1@1.2.3.4*) and the web password defined in Section 6.3. Once logged in, he can change his web password in the *Account* section. This will NOT change his SIP password, so if you control the end user devices, you can auto-provision the SIP password into the device and keep it secret, and just hand over the web password to the customer. This way, the end user will only be able to place calls with this auto-provisioned device and not with an arbitrary soft-phone, but can nonetheless manage his account via the CSC panel.

8.1.2 Site Customization

As an operator (as well as a Reseller), you can change the branding logo of the Customer Self-Care (CSC) panel and the available languages on the CSC panel. This is possible via the admin web interface.

8.1.2.1 Changing the Logo

For changing the branding logo on a reseller's admin web page and on the CSC panel you just need to access the web interface **as Administrator** and navigate to *Reseller* menu. Once there click on the *Details* button for your selected reseller, finally select *Branding*.

In order to do the same **as Reseller**, login on the admin web interface with the reseller's web credentials, then access the *Panel Branding* menu.

The web panel customisation happens as follows:

1. Press the *Edit Branding* button to start the customisation process.
2. Press the *Browse* button to select an image for the new logo:

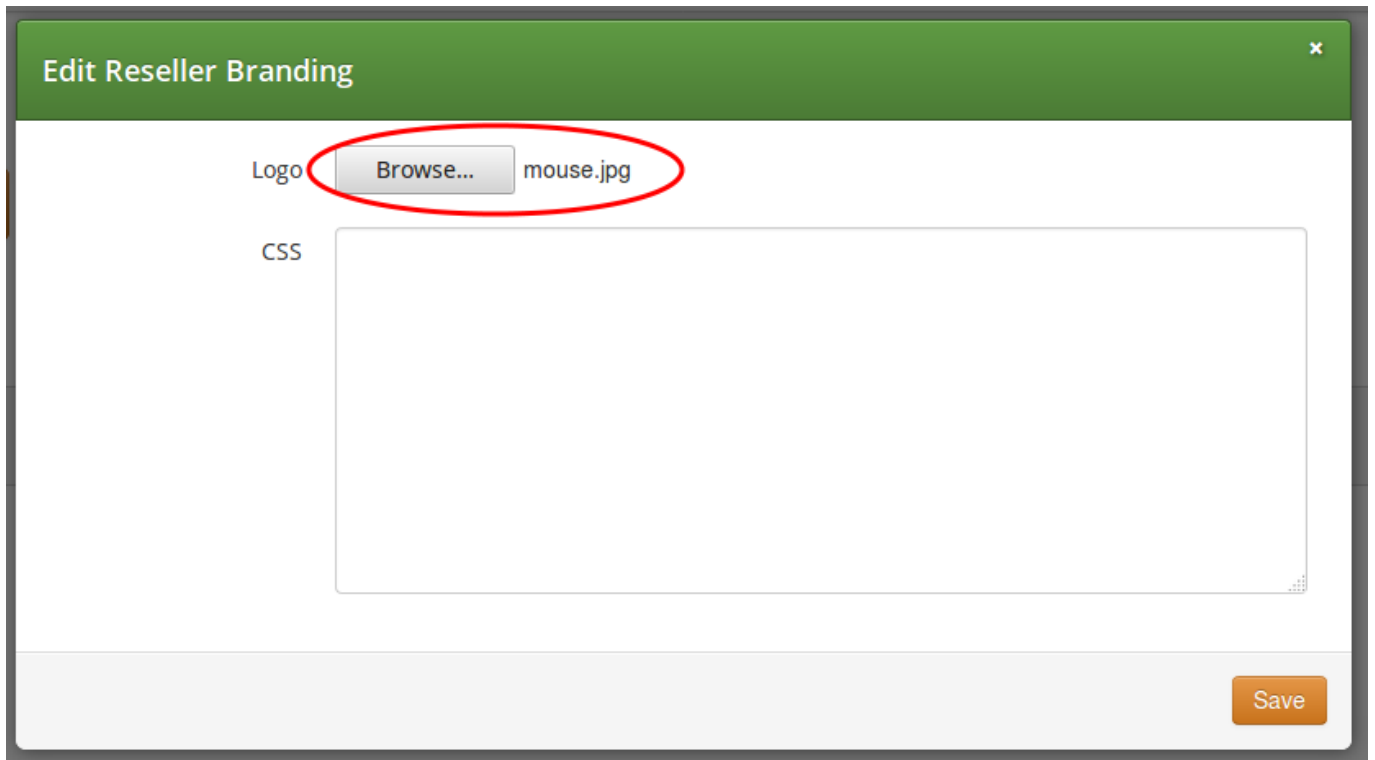



Figure 68: CSC Customisation Step 1: Select an image

3. Press the *Save* button to save changes.
4. Select and copy the auto-generated CSS code from the text box below the uploaded image:

Reseller branding successfully updated

[Edit Branding](#) [Delete Logo](#)

Custom Logo



You can use the logo by adding the following CSS to the Custom CSS below.

```
#header .brand {  
  background: url(https://10.15.18.227:1443/reseller/3/css/logo/download) no-repeat 0 0;  
  background-size: 280px 32px;  
}
```

Custom CSS

Figure 69: CSC Customisation Step 2: Copy CSS code

5. Press the *Edit Branding* button again.
6. Paste the CSS code into CSS text box and Save the changes:

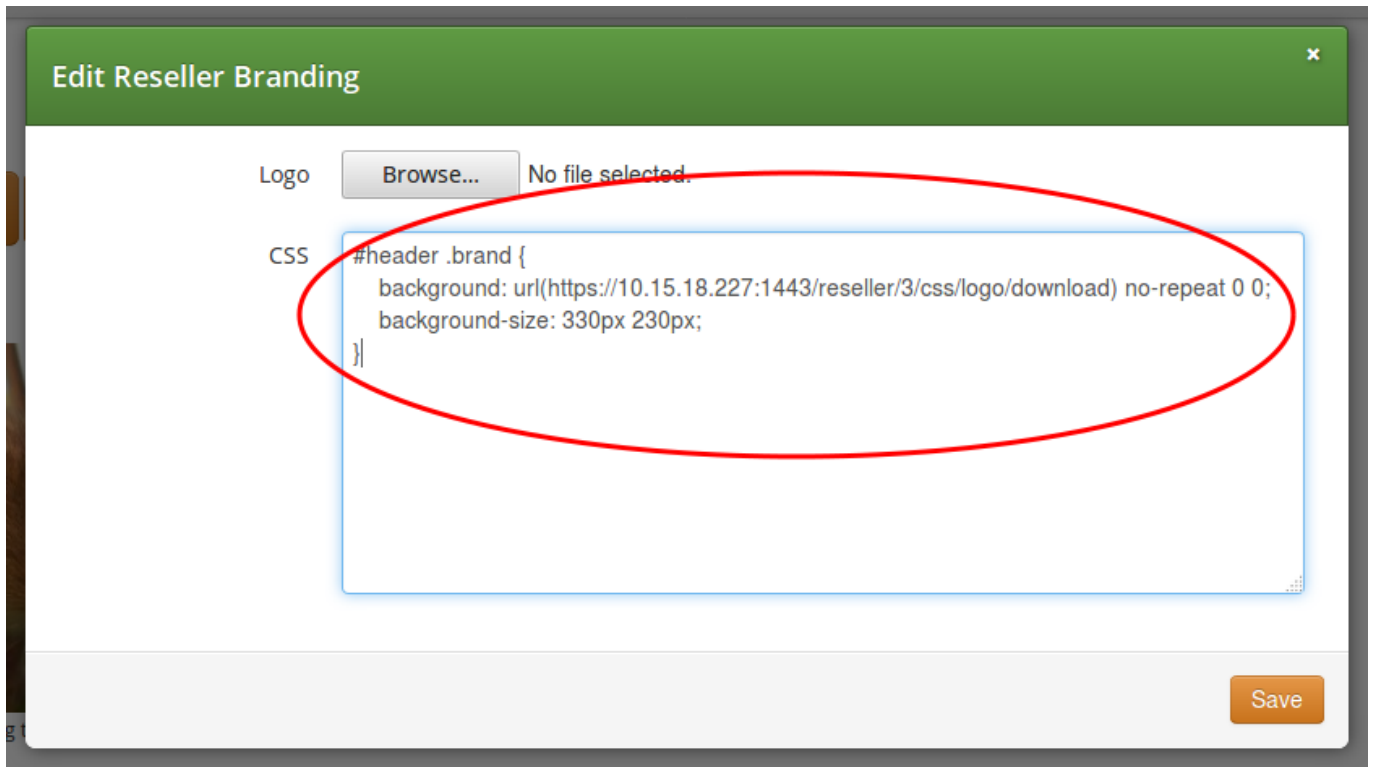

Figure 70: CSC Customisation Step 3: Paste CSS code

7. Now the new logo is already visible on the admin / CSC panel. If you want to hide the Sipwise copyright notice at the bottom of the web panels, add a line of CSS code as shown here:

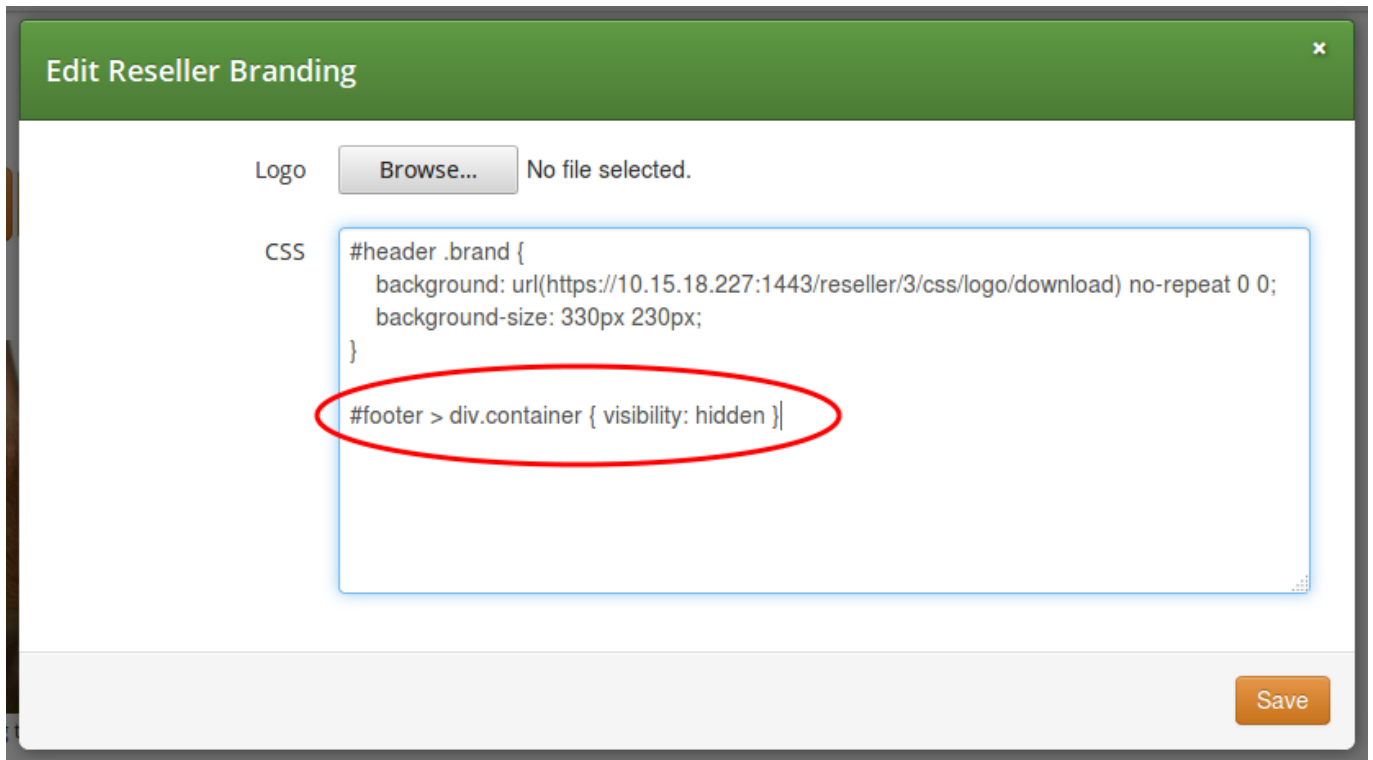

Figure 71: CSC Customisation: Hide copyright notice

8. The final branding data is shown on the admin web panel:

Reseller branding successfully updated

[Edit Branding](#) [Delete Logo](#)

Custom Logo



You can use the logo by adding the following CSS to the Custom CSS below:

```
#header .brand {
  background: url(https://10.15.18.227:1443/reseller/3/css/logo/download) no-repeat 0 0;
  background-size: 280px 32px;
}
```

Custom CSS

```
#header .brand {
  background: url(https://10.15.18.227:1443/reseller/3/css/logo/download) no-repeat 0 0;
  background-size: 330px 230px;
}

#footer > div.container { visibility: hidden }
```

Figure 72: CSC Customisation: Custom data on panel

8.1.2.2 Other Website Customisations

The layout and style of NGCP's admin and CSC web panel is determined by a single CSS file: `/usr/share/ngcp-panel/static/`

More complex changes, like replacing colour of some web panel components, is possible via the modification of the CSS file.



Warning

Only experienced users with profound CSS knowledge are advised to change web panel properties in the main CSS file. *Sipwise does not recommend and also does not support the modification of the main CSS file.*

8.1.2.3 Selecting Available Languages

You can also enable/disable specific languages a user can choose from in the CSC panel. Currently, English (`en`), German (`de`), Italian (`it`), Spanish (`es`) and Russian (`ru`) are supported, and the default language is the same as the browser's preferred one.

You can select the *default language* provided by CSC by changing the parameter `www_admin.force_language` in `/etc/ngcp-co` file. An example to set the English language as default: `force_language: en`

8.2 The Voicemail Menu

Sipwise C5 offers several ways to access the Voicemail box.

The CSC panel allows your users to listen to voicemail messages from the web browser, delete them and call back the user who left the voice message. User can setup voicemail forwarding to the external email and the PIN code needed to access the voicebox from any telephone also from the CSC panel.

To manage the voice messages from SIP phone: simply dial internal voicemail access number 2000.

To change the access number: look for the parameter *voicemail_number* in */etc/ngcp-config/config.yml* in the section *sems*→*vsc*. After the changes, execute *ngcpcfg apply 'changed voicebox number'*.

Tip

To let the callers leave a voice message when user is not available he should enable Call Forward to Voicebox. The Call Forward can be provisioned from the CSC panel as well as by dialing Call Forward VSC with the voicemail number. E.g. when parameter *voicemail_number* is set to 9999, a Call Forward on Not Available to the Voicebox is set if the user dials *93*9999. As a result, all calls will be redirected to the Voicebox if SIP phone is not registered.

To manage the voice messages from any phone:

- As an operator, you can setup some DID number as external voicemail access number: for that, you should add a special rewrite rule (Inbound Rewrite Rule for Callee, see Section 6.7.) on the incoming peer, to rewrite that DID to "voiceboxpass". Now when user calls this number the call will be forwarded to the voicemail server and he will be prompted for mailbox and password. The mailbox is the full E.164 number of the subscriber account and the password is the PIN set in the CSC panel.
- The user can also dial his own number from PSTN, if he setup Call Forward on Not Available to the Voicebox, and when reaching the voicemail server he can interrupt the "user is unavailable" message by pressing * key and then be prompted for the PIN. After entering PIN and confirming with # key he will enter own voicemail menu. PIN is random by default and must be kept secret for that reason.

9 Billing Configuration

This chapter describes the steps necessary to rate calls and export rated CDRs (call detail records) to external systems.

9.1 Billing Profiles

Service billing on Sipwise C5 is based on billing profiles, which may be assigned to customers and SIP peerings. The design focuses on a simple, yet flexible approach, to support arbitrary dial-plans without introducing administrative overhead for the system administrators. The billing profiles may define a base fee and free time or free money per billing interval. Unused free time or money automatically expires at the end of the billing interval.

Each profile may have call destinations (usually based on E.164 number prefix matching) with configurable fees attached. Call destination fees each support individual intervals and rates, with a different duration and/or rate for the first interval. (e.g.: charge the first minute when the call is opened, then every 30 seconds, or make it independent of the duration at all) It is also possible to specify different durations and/or rates for peak and off-peak hours. Peak time may be specified based on weekdays, with additional support for manually managed dates based on calendar days. The call destinations can finally be grouped for an overview on user's invoices by specifying a zone in two detail levels. (E.g.: national landline, national mobile, foreign 1, foreign 2, etc.)

9.1.1 Creating Billing Profiles

The first step when setting up billing data is to create a billing profile, which will be the container for all other billing related data. Go to *Settings*→*Billing* and click on *Create Billing Profile*.

Logged in as administrator Logout

Create Billing Profiles

Reseller Search:

#	Name	Contract #	Status	
1	default	1	active	1 <input checked="" type="checkbox"/>

Showing 1 to 1 of 1 entries

← 1 →

Create Reseller

Handle 2

Name 3

Prepaid

Interval charge

4 Save

The fields *Reseller*, *Handle* and *Name* are mandatory.

- **Reseller:** The reseller this billing profile belongs to.
- **Handle:** A unique, permanently fixed string which is used to attach the billing profile to a customer or SIP peering contract.
- **Name:** A free form string used to identify the billing profile in the *Admin Panel*. This may be changed at any time.
- **Interval charge:** A base fee for the billing interval, specifying a monetary amount (represented as a floating point number) in whatever currency you want to use.
- **Interval free time:** If you want to include free calling time in your billing profile, you may specify the number of seconds that are available every billing interval. See *Creating Billing Fees* below on how to select destinations which may be called using the free time.
- **Interval free cash:** Same as for *interval free time* above, but specifies a monetary amount which may be spent on outgoing calls. This may be used for example to implement a minimum turnover for a contract, by setting the *interval charge* and *interval free cash* to the same values.
- **Fraud monthly limit:** The monthly fraud detection limit (in Cent) for accounts with this billing profile. If the call fees of an account reach this limit within a billing interval, an action can be triggered.
- **Fraud monthly lock:** a choice of *none*, *foreign*, *outgoing*, *incoming*, *global*. Specifies a lock level which will be used to lock the account and his subscribers when *fraud monthly limit* is exceeded.
- **Fraud monthly notify:** An email address or comma-separated list of email addresses that will receive notifications when *fraud monthly limit* is exceeded.

- **Fraud daily limit:** The fraud detection limit (in Cent) for accounts with this billing profile. If the call fees of an account reach this limit within a calendar day, an action can be triggered.
- **Fraud daily lock:** a choice of *none, foreign, outgoing, incoming, global*. Specifies a lock level which will be used to lock the account and his subscribers when *fraud daily limit* is exceeded.
- **Fraud daily notify:** An email address or comma-separated list of email addresses that will receive notifications when *fraud daily limit* is exceeded.
- **Currency:** The currency symbol for your currency. Any UTF-8 character may be used and will be printed in web interfaces.
- **VAT rate:** The percentage of value added tax for all fees in the billing profile. Currently for informational purpose only and not used further.
- **VAT included:** Whether VAT is included in the fees entered in web forms or uploaded to the platform. Currently for informational purpose only and not used further.

9.1.2 Creating Billing Fees

Each *Billing Profile* holds multiple *Billing Fees*.

To set up billing fees, click on the *Fees* button of the billing profile you want to configure. Billing fees may be uploaded using a configurable CSV file format, or entered directly via the web interface by clicking *Create Fee Entry*. To configure the CSV field order for the file upload, rearrange the entries in the `www_admin→fees_csv→element_order` array in `/etc/ngcp-config/config.yml` and execute the command `ngcpcfg apply changed_fees_element_order`. The following is an example of working CSV file to upload (pay attention to double quotes):

```
".", "^1", out, "EU", "ZONE EU", 5.37, 60, 5.37, 60, 5.37, 60, 5.37, 60, 0, 0, regex_longest_pattern
"^01.+$", "^02145.+$", out, "AT", "ZONE Test", 0.06250, 1, 0.06250, 1, 0.01755, 1, 0.01733, 1, 0, ↵
  regex_longest_pattern
```

For input via the web interface, just fill in the text fields accordingly.

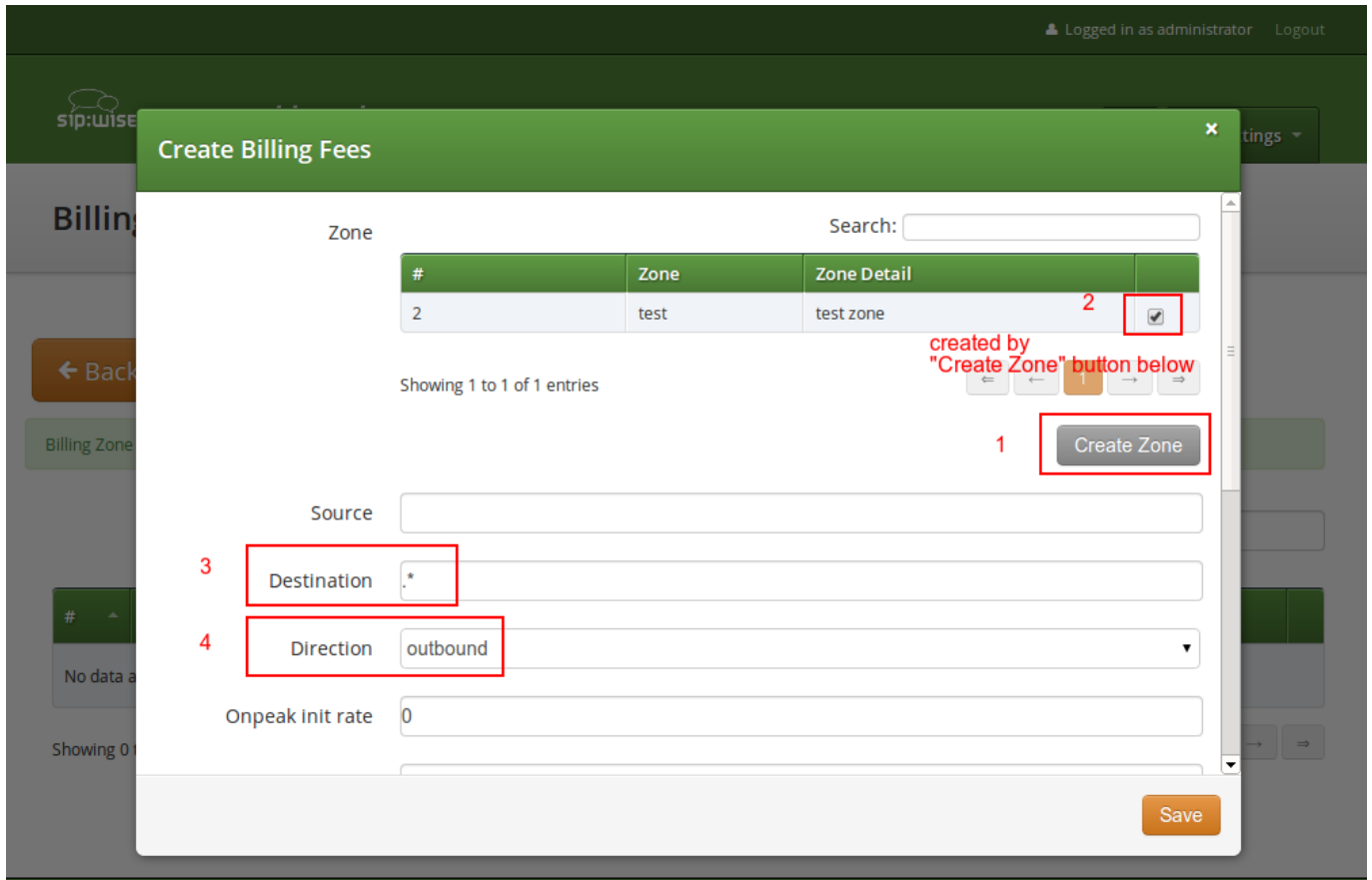

A billing fee record essentially defines the rate per interval to charge the customer when calling a particular destination number. The properties below outline supported options in detail:

- **Zone:** A zone for a group of fees. May be used to group fees for simplified display, e.g. on invoices. (e.g. *foreign zone 1*)
- **Match Mode:** The mode for matching a fee's source and destination patterns against a CDR's source fields (the caller given by `<source_cli>@<source_domain>` or `<source_cli>` only) and destination fields (the callee given by `<destination_user_in>` or `<destination_user_in>` only). Each of the currently supported modes below provide different flexibility and speed:
 1. **Exact string (destination):** The destination string has to match the destination from the CDR exactly. Fastest, $O(\log(\#fees))$. In csv files, this match mode is specified by `exact_destination`.
 2. **Prefix string:** The fee's source/destination represent strings which both the source/destination from the CDR have to start with. The fee with the longest destination prefix is picked. If there are multiple, the one with the longest source prefix is picked. In contrast to regular-expression based match modes, this algorithm uses database index lookups instead of SQL REGEXP table scans. The performance boundary is $O(\text{length}(\text{cdr src}) * \text{length}(\text{cdr dest}) * \log(\#fees))$, hence this will be the preferred mode for tens of thousands of fees in place or high throughput (LCR, rating peer-to-peer calls). In csv files, this match mode is specified by `prefix`.
 3. **Regular expression - longest match:** The fee's source/destination patterns represent PCREs which both have to match the source/destination from the CDR. The fee with the longest match within the destination string is picked. If there are multiple, the one with the longest match within the source string is picked. In csv files, this match mode is specified by `regex_longest_match`.
 4. **Regular expression - longest pattern:** The fee's source/destination represent PCREs which both have to match the

source/destination from the CDR. The fee with the longest (most distinctive) destination pattern is picked. If there are multiple, the one with the longest (most distinctive) source pattern is picked. In csv files, this match mode is specified by `regex_longest_pattern`.

If fees with different match mode are in place and matching, the precedence is given by above order. When omitted in file uploads, the legacy default `regex_longest_pattern` is used.

- **Source:** The source pattern (prefix ie. 123 or regular expression `^123someone@sip\.sipwise\.com$`). The legacy default " ." regular expression (matching everything) will be set implicitly.
- **Destination:** The destination pattern (string ie. 456somebody@sip.sipwise.com, prefix ie. 456 or regular expression `^456somebody@sip\.sipwise\.com$`). This field must be set.
 - To specify a special fixed rate for any ported number in the local LNP tables belonging to an LNP provider, a fee with `exact_destination` match mode and `destination_lnp:<lnp_provider ID>` can be set up.
 - To specify an FCI (Furnished Charging Info) destination for cases when the FCI data is retrieved from the LNP lookup, use a format `fci=10050` where "10050" is the FCI data.
- **Direction:** `Outbound` for standard origination fees (applies to callers placing a call and getting billed for that) or `Inbound` for termination fees (applies to callees if you want to charge them for receiving various calls, e.g. for 800-numbers). *If in doubt, use Outbound.* If you upload fees via CSV files, use `out` or `in`, respectively.



Important

The {match mode, source, destination, direction} combination needs to be unique for a billing profile. The system will return an error if such a set is specified twice via web interface/ or /api, or skipped when processing the file upload.



Important

There are several internal services (`vsc`, `conference`, `voicebox`) which will need a specific destination entry with a domain-based destination. If you don't want to charge the same (or nothing) for those services, add a fee for destination `\.local$` there. If you want to charge different amounts for those services, break it down into separate fee entries for `@vsc\.local$`, `@conference\.local$` and `@voicebox\.local$` with the according fees. **NOT CREATING EITHER THE CATCH-ALL FEE OR THE SEPARATE FEES FOR THE `.local` DOMAIN WILL BREAK YOUR RATING PROCESS!**

- **Onpeak init rate:** The rate for the first rating interval in cent (of whatever currency, represented as a floating point number) per second. Applicable to calls during onpeak hours.
- **Onpeak init interval:** The duration of the first billing interval, in seconds. Applicable to calls during onpeak hours.
- **Onpeak follow rate:** The rate for subsequent rating intervals in cent (of whatever currency, represented as a floating point number) per second. Applicable to calls during onpeak hours. Defaults to *onpeak init rate*.
- **Onpeak follow interval:** The duration of subsequent billing intervals, in seconds. Applicable to calls during onpeak hours. Defaults to *onpeak init interval*.

- **Offpeak init rate:** The rate for the first rating interval in cent (of whatever currency, represented as a floating point number) per second. Applicable to calls during off-peak hours. Defaults to *onpeak init rate*.
- **Offpeak init interval:** The duration of the first billing interval, in seconds. Applicable to calls during off-peak hours. Defaults to *onpeak init interval*.
- **Offpeak follow rate:** The rate for subsequent rating intervals in cent (of whatever currency, represented as a floating point number) per second. Applicable to calls during off-peak hours. Defaults to *offpeak init rate* if that one is specified, or to *onpeak follow rate* otherwise.
- **Offpeak follow interval:** The duration of subsequent billing intervals, in seconds. Applicable to calls during off-peak hours. Defaults to *offpeak init interval* if that one is specified, or to *onpeak follow interval* otherwise.
- **Use free time:** Specifies whether free time minutes may be used when calling this destination. May be specified in the file upload as 0, n[o], f[alse] and 1, y[es], t[rue] respectively.

9.1.3 Creating Off-Peak Times

To be able to differentiate between on-peak and off-peak calls, the platform stores off-peak times for every billing profile based on weekdays and/or calendar days. To edit the settings for a billing profile, go to *Settings*→*Billing* and press the *Off-Peaktimes* button on the billing profile you want to configure.

To set off-peak times for a weekday, click on *Edit* next to the according weekday. You will be presented with two input fields which both receive a timestamp in the form of *hh:mm:ss* specifying a time of day for the start and end of the off-peak period. If any of the fields is left empty, the system will automatically insert *00:00:00* (*start* field) or *23:59:59* (*end* field). Click on *Add* to store the setting in the database. You may create more than one off-peak period per weekday. To delete a range, just click *Delete* next to the entry. Click the *close* icon when done.

The screenshot shows the 'Edit Monday' dialog box in the Sipwise interface. The dialog contains three time input fields. The first field shows '00:00:00' and the second shows '07:59:59'. The third field is split into two parts: '18:00:00' (labeled '1') and '23:59:59' (labeled '2'). To the right of these fields is a trash icon and an 'Add' button (labeled '3'). Below the dialog, a table lists weekdays and their corresponding start and end times.

Weekday	Start - End
Monday	00:00:00 - 07:59:59
Tuesday	
Wednesday	
Thursday	
Friday	
Saturday	

To specify off-peak ranges based on calendar dates, click on *Create Special Off-Peak Date*. Enter a date in the form of *YYYY-MM-DD hh:mm:ss* into the *Start Date/Time* input field and *End Date/Time* input field to define a range for the off-peak period.

1 Start Date/Time 2013-12-24 00:00:00

2 End Date/Time 2013-12-24 23:59:59

3 Save

Weekday	Start - End
Monday	00:00:00 - 07:59:59 18:00:00 - 23:59:59
Tuesday	
Wednesday	
Thursday	
Friday	

9.2 Fraud Detection and Locking

The Sipwise C5 supports a fraud detection feature, which is designed to detect accounts causing unusually high customer costs, and then to perform one of several actions upon those accounts. This feature can be enabled and configured through two sets of billing profile options described in Section 9.1.1, namely the monthly (*fraud monthly limit*, *fraud monthly lock* and *fraud monthly notify*) and daily limits (*fraud daily limit*, *fraud daily lock* and *fraud daily notify*). Either monthly/daily limits or both of them can be active at the same time.

Monthly fraud limit check runs once a day, shortly after midnight local time and daily fraud limit check runs every 30min. A background script (managed by cron daemon) automatically checks all accounts which are linked to a billing profile enabled for fraud detection, and selects those which have caused a higher cost than the *fraud monthly limit* configured in the billing profile, within the currently active billing interval (e.g. in the current month), or a higher cost than the *fraud daily limit* configured in the billing profile, within the calendar day. It then proceeds to perform at least one of the following actions on those accounts:

- If **fraud lock** is set to anything other than *none*, it will lock the account accordingly (e.g. if **fraud lock** is set to *outgoing*, the account will be locked for all outgoing calls).
- If anything is listed in **fraud notify**, an email will be sent to the email addresses configured. The email will contain information about which account is affected, which subscribers within that account are affected, the current account balance and the configured fraud limit, and also whether or not the account was locked in accordance with the **fraud lock** setting. It should be noted that this email is meant for the administrators or accountants etc., and not for the customer.

9.2.1 Fraud Lock Levels

Fraud lock levels are various protection (and notification) settings that are applied to subscribers of a *Customer*, if fraud detection is enabled in the currently active billing profile and the *Customer's* daily or monthly fraud limit has been exceeded.

The following lock levels are available:

- `none`: no account locking will happen
- `foreign calls`: only calls within the subscriber's own domain, and emergency calls, are allowed
- `all outgoing calls`: subscribers of the customer cannot place any calls, except calls to free and emergency destinations
- `incoming and outgoing`: subscribers of the customer cannot place and receive any calls, except calls to free and emergency destinations
- `global`: same restrictions as at `incoming and outgoing` level, additionally subscribers are not allowed to access the Customer Self Care (CSC) interface
- `ported`: only automatic call forwarding, due to number porting, is allowed



Important

You can override fraud detection and locking settings of a billing profile on a per-account basis via REST API or the Admin interface.



Caution

Accounts that were automatically locked by the fraud detection feature will **not** be automatically unlocked when the next billing interval starts. This has to be done manually through the administration panel or through the provisioning interface.



Important

If fraud detection is configured to only send an email and not lock the affected accounts, it will continue to do so for over-limit accounts every day. The accounts must either be locked in order to stop the emails (only currently active accounts are considered when the script looks for over-limit accounts) or some other action to resolve the conflict must be taken, such as disabling fraud detection for those accounts.

Note

It is possible to fetch the list of fraud events and thus get fraud status of *Customers* by using the REST API and referring to the resource: `/api/customerfraudevents`.

9.3 Notes on Billing and Call Rating

Cash balance with post-paid billing profile

Customers with a post-paid billing profile may have a positive account cash balance value. This is the regular case when using a post-paid billing profile showing a *free cash* greater than 0.

Tip

You can set the free cash (and the free time) in the billing profile. The account balance will be set and managed (i.e. refilled or carried over) automatically for subsequent balance intervals.

In case the account has a positive cash balance, the cost of the call will be deducted from that balance and not considered as additional cost of that particular call for the customer.

**Important**

The rating engine (*ngcp-rate-o-mat*) in Sipwise C5 will write 0 instead of the real cost of a call in the CDR, if the source customer's (who initiated the call) account has a positive cash balance! The purpose of this is to reflect the usage of free cash in the CDR for the particular call.

Note

It might happen, for instance, that a customer's billing profile is changed from pre-paid to post-paid, and the customer already had a positive cash balance on his account. In that case the same call rating mechanism is involved as for the free cash.

9.4 Billing Data Export

Regular billing data export is done using CSV (*comma separated values*) files which may be downloaded from the platform using the *cdrexpert* user which has been created during the installation.

There are two types of exports. One is *CDR* (Call Detail Records) used to charge for calls made by subscribers, and the other is *EDR* (Event Detail Records) used to charge for provisioning events like enabling certain features.

9.4.1 Glossary of Terms

Billing records contain fields that hold data of various entities that play a role in the phone service offered by Sipwise C5. For a better understanding of billing data please refer to the glossary provided here:

- **Account:** the customer's account that is charged for calls of its subscriber(s)
- **Carrier:** a SIP peer that sends incoming calls to, or receives outgoing calls from NGCP. A carrier may charge fees for the outgoing calls from Sipwise C5 (outbound billing fee), or for the incoming calls to Sipwise C5 (inbound billing fee).
- **Contract:** the service contract that represents a customer, a reseller or a SIP peer; a contract on Sipwise C5 contains the billing profile (billing fees) too
- **Customer:** the legal entity that represents any number of subscribers; this entity receives the bills for calls of its subscriber(s)
- **Provider:** either the reseller that holds a subscriber who is registered on NGCP, or the SIP peer that handles calls between an external subscriber and NGCP

- **Reseller:** the entity who is the direct, administrative service provider of a group of customers and subscribers registered on NGCP; Sipwise C5 operator may also charge a reseller for the calls initiated or received by its subscribers
- **User:** the subscriber who either is registered on NGCP, or is an external call party

9.4.2 File Name Format

In order to be able to easily identify billing files, the file names are constructed by the following fixed-length fields:

```
<prefix><separator><version><separator><timestamp><separator><sequence number>< ←
  suffix>
```

The definition of the specific fields is as follows:

Table 9: CDR/EDR export file name format

File name element	Length	Description
<prefix>	7	A fixed string. Always sipwise.
<separator>	1	A fixed character. Always _.
<version>	3	The format version, a three digit number. Currently 007.
<timestamp>	14	The file creation timestamp in the format YYYYMMDDhhmmss.
<sequence number>	10	A unique 10-digit zero-padded sequence number for quick identification.
<suffix>	4	A fixed string. Always .cdr or .edr.

A valid example filename for a CDR billing file created at 2012-03-10 14:30:00 and being the 42nd file exported by the system, is:

```
sipwise_007_20130310143000_0000000042.cdr
```

9.4.3 File Format

Each billing file consists of three parts: one header line, zero to 5000 body lines and one trailer line.

9.4.3.1 File Header Format

The billing file header is one single line, which is constructed by the following fields:

```
<version>,<number of records>
```

The definition of the specific fields is as follows:

Table 10: CDR/EDR export file header line format

Body Element	Length	Type	Description
<version>	3	zero-padded uint	The format version. Currently 007.
<number of records>	4	zero-padded uint	The number of body lines contained in the file.

A valid example for a Header is:

```
007,0738
```

9.4.3.2 File Body Format for Call Detail Records (CDR)

The body of a CDR consists of a minimum of zero and a default maximum of 5000 lines. The platform operator can configure the maximum number of lines kept in a file by updating the `cdrexport.max_rows_per_file` parameter in `/etc/ngcp-config/cdr` file. Each line holds one call detail record in CSV format and is constructed by a configurable set of fields, all of them enclosed in single quotes.

The following table defines the **default set of fields** that are inserted into the CDR file, for exports related to *system* scope. The list of fields is defined in `/etc/ngcp-config/config.yml` file, `cdrexport.admin_export_fields` parameter.

Table 11: Default set of system CDR fields

Body Element	Length	Type	Description
CDR_ID	1-10	uint	Internal CDR ID.
UPDATE_TIME	19	timestamp	Timestamp of last modification, including date and time (with seconds precision).
SOURCE_USER_ID	36	string	Internal UUID of calling party subscriber. Value is 0 if calling party is external.
SOURCE_PROVIDER_ID	0-255	string	Internal ID of the contract of calling party provider (i.e. reseller or peer).

Table 11: (continued)

Body Element	Length	Type	Description
SOURCE_EXTERNAL_SUBSCRIBER_ID	0-255	string	External, arbitrary ID of calling party subscriber. (A string value shown as "External ID" property of an Sipwise C5 subscriber.)
SOURCE_SUBSCRIBER_ID	1-11	uint	Internal ID of calling party subscriber. Value is 0 if calling party is external.
SOURCE_EXTERNAL_CONTRACT_ID	0-255	string	External, arbitrary ID of calling party customer. (A string value shown as "External ID" property of an Sipwise C5 customer/peer.)
SOURCE_ACCOUNT_ID	1-11	uint	Internal ID of calling party customer.
SOURCE_USER	0-255	string	SIP username of calling party.
SOURCE_DOMAIN	0-255	string	SIP domain of calling party.
SOURCE_CLI	0-64	string	CLI of calling party in E.164 format.
SOURCE_CLIR	1	uint	1 for calls with CLIR, 0 otherwise.
SOURCE_IP	0-64	string	IP Address of the calling party.
DESTINATION_USER_ID	36	string	Internal UUID of called party subscriber. Value is 0 if called party is external.
DESTINATION_PROVIDER_ID	0-255	string	Internal ID of the contract of called party provider (i.e. reseller or peer).
DESTINATION_EXTERNAL_SUBSCRIBER_ID	0-255	string	External, arbitrary ID of called party subscriber. (A string value shown as "External ID" property of an Sipwise C5 subscriber.)
DESTINATION_SUBSCRIBER_ID	1-11	uint	Internal ID of called party subscriber. Value is 0 if calling party is external.
DESTINATION_EXTERNAL_CONTRACT_ID	0-255	string	External, arbitrary ID of called party customer. (A string value shown as "External ID" property of an Sipwise C5 customer/peer.)
DESTINATION_ACCOUNT_ID	1-11	uint	Internal ID of called party customer.
DESTINATION_USER	0-255	string	Final SIP username of called party.
DESTINATION_DOMAIN	0-255	string	Final SIP domain of called party.
DESTINATION_USER_IN	0-255	string	Incoming SIP username of called party, after applying inbound rewrite rules.
DESTINATION_DOMAIN_IN	0-255	string	Incoming SIP domain of called party, after applying inbound rewrite rules.
DESTINATION_USER_DIALED	0-255	string	The user-part of the SIP Request URI as received by NGCP.

Table 11: (continued)

Body Element	Length	Type	Description
PEER_AUTH_USER	0-255	string	Username used to authenticate towards peer.
PEER_AUTH_REALM	0-255	string	Realm used to authenticate towards peer.
CALL_TYPE	3-4	string	The type of the call - one of: call: normal call cfu: call forward unconditional cfb: call forward busy cft: call forward timeout cfna: call forward not available cfs: call forward for SMS cfr: call forward rerouting
CALL_STATUS	2-8	string	The final call status - one of: ok: successful call busy: called party busy noanswer: no answer from called party cancel: cancel from caller offline called party offline timeout: no reply from called party other: unspecified, see CALL_CODE field for details
CALL_CODE	3	string	The final SIP status code.
INIT_TIME	23	timestamp	Timestamp of call initiation (SIP <i>INVITE</i> received from calling party). Includes date, time with milliseconds (3 decimals).
START_TIME	23	timestamp	Timestamp of call establishment (final SIP response received from called party). Includes date, time with milliseconds (3 decimals).
DURATION	4-13	fixed precision (3 decimals)	Length of call (calculated from START_TIME) including milliseconds (3 decimals).
CALL_ID	0-255	string	The SIP Call-ID.

Table 11: (continued)

Body Element	Length	Type	Description
RATING_STATUS	2-7	string	The internal rating status of the CDR - one of: unrated: not rated ok: successfully rated failed: error while rating Currently always ok or unrated, depending on whether rating is enabled or not.
RATED_AT	0-19	datetime	Time of rating, including date and time (with seconds precision). Empty if CDR is not rated.
SOURCE_CARRIER_COST	7-14	fixed precision (6 decimals)	The originating carrier cost that the carrier (i.e. SIP peer) charges for the calls routed to his network, or empty if CDR is not rated. <i>PLEASE NOTE: Only available in system exports, not for resellers.</i>
SOURCE_CUSTOMER_COST	7-14	fixed precision (6 decimals)	The originating customer cost, or empty if CDR is not rated.
SOURCE_CARRIER_ZONE	0-127	string	Name of the originating carrier billing zone, or onnet if data is not available. <i>PLEASE NOTE: Only available in system exports, not for resellers.</i>
SOURCE_CUSTOMER_ZONE	0-127	string	Name of the originating customer billing zone, or empty if CDR is not rated.
SOURCE_CARRIER_DETAIL	0-127	string	Description of the originating carrier billing zone, or platform internal if data is not available. <i>PLEASE NOTE: Only available in system exports, not for resellers.</i>
SOURCE_CUSTOMER_DETAIL	0-127	string	Description of the originating customer billing zone, or empty if CDR is not rated.
SOURCE_CARRIER_FREE_TIME	1-10	uint	The number of free time seconds used on originating carrier side, or empty if CDR is not rated. <i>PLEASE NOTE: Only available in system exports, not for resellers.</i>

Table 11: (continued)

Body Element	Length	Type	Description
SOURCE_CUSTOMER_FREE_TIME	1-10	uint	The number of free time seconds used from the originating customer's account balance, or empty if CDR is not rated.
DESTINATION_CARRIER_COST	7-14	fixed precision (6 decimals)	The terminating carrier cost, or empty if CDR is not rated. <i>PLEASE NOTE: Only available in system exports, not for resellers.</i>
DESTINATION_CUSTOMER_COST	7-14	fixed precision (6 decimals)	The terminating customer cost, or empty if CDR is not rated.
DESTINATION_CARRIER_ZONE	0-127	string	Name of the terminating carrier billing zone, or <code>onnet</code> if data is not available. <i>PLEASE NOTE: Only available in system exports, not for resellers.</i>
DESTINATION_CUSTOMER_ZONE	0-127	string	Name of the terminating customer billing zone, or empty if CDR is not rated.
DESTINATION_CARRIER_DETAIL	0-127	string	Description of the terminating carrier billing zone, or empty if CDR is not rated. <i>PLEASE NOTE: Only available in system exports, not for resellers.</i>
DESTINATION_CUSTOMER_DETAIL	0-127	string	Description of the terminating customer billing zone, or empty if CDR is not rated.
DESTINATION_CARRIER_FREE_TIME	1-10	uint	The number of free time seconds used on terminating carrier side, or empty if CDR is not rated. <i>PLEASE NOTE: Only available in system exports, not for resellers.</i>
DESTINATION_CUSTOMER_FREE_TIME	1-10	uint	The number of free time seconds used from the terminating customer's account balance, or empty if CDR is not rated.
SOURCE_RESELLER_COST	7-14	fixed precision (6 decimals)	The originating reseller cost, or empty if CDR is not rated. <i>PLEASE NOTE: Only available in system exports, not for resellers.</i>

Table 11: (continued)

Body Element	Length	Type	Description
SOURCE_RESELLER_ZONE	0-127	string	Name of the originating reseller billing zone, or empty if CDR is not rated. <i>PLEASE NOTE: Only available in system exports, not for resellers.</i>
SOURCE_RESELLER_DETAIL	0-127	string	Description of the originating reseller billing zone, or empty if CDR is not rated. <i>PLEASE NOTE: Only available in system exports, not for resellers.</i>
SOURCE_RESELLER_FREE_TIME	1-10	uint	The number of free time seconds used from the originating reseller's account balance, or empty if CDR is not rated. <i>PLEASE NOTE: Only available in system exports, not for resellers.</i>
DESTINATION_RESELLER_COST	7-14	fixed precision (6 decimals)	The terminating reseller cost, or empty if CDR is not rated. <i>PLEASE NOTE: Only available in system exports, not for resellers.</i>
DESTINATION_RESELLER_ZONE	0-127	string	Name of the terminating reseller billing zone, or empty if CDR is not rated. <i>PLEASE NOTE: Only available in system exports, not for resellers.</i>
DESTINATION_RESELLER_DETAIL	0-127	string	Description of the terminating reseller billing zone, or empty if CDR is not rated. <i>PLEASE NOTE: Only available in system exports, not for resellers.</i>
DESTINATION_RESELLER_FREE_TIME	1-10	uint	The number of free time seconds used from the terminating reseller's account balance, or empty if CDR is not rated. <i>PLEASE NOTE: Only available in system exports, not for resellers.</i>
<line_terminator>	1	string	Always \n (special char LF - ASCII 0x0A).

A valid example of one body line of a rated CDR is (line breaks added for clarity):

```
'15', '2013-03-26 22:09:11', 'a84508a8-d256-4c80-a84e-820099a827b0', '1', '', '1', '',
```

```
'2','testuser1','192.168.51.133','4311001','0','192.168.51.1',
'94d85b63-8f4b-43f0-b3b0-221c9e3373f2','1','','3','','4','testuser3',
'192.168.51.133','testuser3','192.168.51.133','testuser3','','','call','ok','200',
'2013-03-25 20:24:50.890','2013-03-25 20:24:51.460','10.880','44449842',
'ok','2013-03-25 20:25:27','0.00','24.00','onnet','testzone','platform internal',
'testzone','0','0','0.00','200.00','','foo','','foo','0','0',
'0.00','','','0','0.00','','','0'
```

The format of the **CDR export files generated for resellers** (as opposed to the complete system-wide export) is identical except for a few missing fields.

Note

Please check the description of fields in the table above, in order to see which fields are omitted for *reseller* related CDR exports.

The list of fields for *reseller* CDR export is defined in `/etc/ngcp-config/config.yml` file, `cdrexport.reseller_export` parameter.

9.4.3.3 Extra fields that can be exported to CDRs

Supplementary Data

There are fields in CDR database that contain **supplementary data** related to subscribers. This data is not used by Sipwise C5 for CDR processing but rather provides the system administrator with a possibility to include supplementary information in CDRs.

Note

This informational section is meant for problem solving / debugging purpose: The supplementary data listed in following table is stored in `provisioning.voip_preferences` database table.

Table 12: Supplementary data in CDR fields

Body Element	Length	Type	Description
SOURCE_GPP0	0-255	string	Supplementary data field 0 of calling party.
SOURCE_GPP1	0-255	string	Supplementary data field 1 of calling party.
SOURCE_GPP2	0-255	string	Supplementary data field 2 of calling party.
SOURCE_GPP3	0-255	string	Supplementary data field 3 of calling party.
SOURCE_GPP4	0-255	string	Supplementary data field 4 of calling party.
SOURCE_GPP5	0-255	string	Supplementary data field 5 of calling party.
SOURCE_GPP6	0-255	string	Supplementary data field 6 of calling party.
SOURCE_GPP7	0-255	string	Supplementary data field 7 of calling party.
SOURCE_GPP8	0-255	string	Supplementary data field 8 of calling party.
SOURCE_GPP9	0-255	string	Supplementary data field 9 of calling party.

Table 12: (continued)

Body Element	Length	Type	Description
DESTINATION_GPP0	0-255	string	Supplementary data field 0 of called party.
DESTINATION_GPP1	0-255	string	Supplementary data field 1 of called party.
DESTINATION_GPP2	0-255	string	Supplementary data field 2 of called party.
DESTINATION_GPP3	0-255	string	Supplementary data field 3 of called party.
DESTINATION_GPP4	0-255	string	Supplementary data field 4 of called party.
DESTINATION_GPP5	0-255	string	Supplementary data field 5 of called party.
DESTINATION_GPP6	0-255	string	Supplementary data field 6 of called party.
DESTINATION_GPP7	0-255	string	Supplementary data field 7 of called party.
DESTINATION_GPP8	0-255	string	Supplementary data field 8 of called party.
DESTINATION_GPP9	0-255	string	Supplementary data field 9 of called party.

Account balance details (prepaid calls)

There are fields in CDR database that show **changes in cash or free time balance**. In addition to that, a history of billing packages / profiles may also be present, since Sipwise C5 vouchers, that are used to top-up, may also be set up to cause a transition of profile packages. (Which in turn can result in changing the billing profile/applicable fees). Therefore the billing package and profile valid at the time of the CDR are recorded and exposed as fields for CDR export.

Tip

Such fields may also be required to integrate Sipwise C5 with legacy billing systems.

Note

Please be aware that pre-paid billing functionality is only available in *Sipwise C5 PRO* and *Sipwise C5 CARRIER* products.

The name of CDR data field consists of the elements listed below:

1. `source|destination`: decides if the data refers to calling (source) or called (destination) party
2. `carrier|reseller|customer`: the account owner, whose billing data is referred
3. data type:
 - A. `cash_balance|free_time_balance _ before|after`: cash balance or free time balance, before or after the call
 - B. `profile_package_id|contract_balance_id`: internal ID of the active pre-paid billing profile or the account balance

Examples:

- `source_customer_cash_balance_before`
- `destination_customer_profile_package_id`



Important

For calls spanning multiple balance intervals, the latter one will be selected, that is the balance interval where the call ended.

9.4.3.4 Distinguish between on-net and off-net calls CDRs

On-net calls (made only between devices on your network) are sometimes treated differently from off-net calls (terminated to or received from a peer) in external billing systems.

To distinguish between on-net and off-net calls in such a billing systems, check the **source_user_id** and **destination_user_id** fields. For on-net calls, both fields will have a different from zero value (actually, a UUID).

9.4.3.5 File Body Format for Event Detail Records (EDR)

The body of an EDR consists of a minimum of zero and a maximum of 5000 lines. The platform operator can configure the maximum number of lines kept in a file by updating the `eventexport.max_rows_per_file` parameter in `/etc/ngcp-config/config.yml` file. Each line holds one call detail record in CSV format and is constructed by the fields as per the subsequent table.

The following table defines the **default set of fields** that are inserted into the EDR file, for exports related to *system* scope. The list of fields is defined in `/etc/ngcp-config/config.yml` file, `eventexport.admin_export_fields` parameter.

Table 13: Default set of system EDR fields

Body Element	Length	Type	Description
EVENT_ID	1-11	uint	Internal EDR ID.
TYPE	0-255	string	The type of the event - one of: <code>start_profile</code> : A subscriber profile has been newly assigned to a subscriber. <code>end_profile</code> : A subscriber profile has been removed from a subscriber. <code>update_profile</code> : A subscriber profile has been changed for a subscriber. <code>start_huntgroup</code> : A subscriber has been provisioned as PBX / hunting group. <code>end_huntgroup</code> : A subscriber has been deprovisioned as PBX / hunting group. <code>start_ivr</code> : A subscriber has a new call-forward to Auto-Attendant. <code>end_ivr</code> : A subscriber has removed a call-forward to Auto-Attendant.

Table 13: (continued)

Body Element	Length	Type	Description
CONTRACT_EXTERNAL_ID	0-255	string	The external ID of the customer. (A string value shown as "External ID" property of an Sipwise C5 customer.)
COMPANY	0-127	string	The company name of the customer's contact.
SUBSCRIBER_EXTERNAL_ID	0-255	string	The external ID of the subscriber. (A string value shown as "External ID" property of an Sipwise C5 subscriber.) <i>PLEASE NOTE: This field is empty in case of start_huntgroup and end_huntgroup events.</i>
PILOT_PRIMARY_NUMBER	0-64	string	The pilot subscriber's primary number (HPBX subscribers). <i>PLEASE NOTE: This is not included in default set of EDR fields from Sipwise C5 version mr5.0 upwards.</i>
PRIMARY_NUMBER	0-64	string	The VoIP number of the subscriber with the highest ID (DID or primary number).
OLD_PROFILE_NAME	0-255	string	The old status of the event. Depending on the event_type: start_profile: Empty. end_profile: The name of the subscriber profile which got removed from the subscriber. update_profile: The name of the former subscriber profile which got updated. start_huntgroup: Empty. end_huntgroup: Empty. start_ivr: Empty. end_ivr: Empty.
NEW_PROFILE_NAME	0-255	string	The new status of the event. Depending on the event_type: start_profile: The name of the subscriber profile which got assigned to the subscriber. end_profile: Empty. update_profile: The name of the new subscriber profile which got applied. start_huntgroup: Empty. end_huntgroup: Empty. start_ivr: Empty. end_ivr: Empty.
TIMESTAMP	23	timestamp	Timestamp of event. Includes date, time with milliseconds (3 decimals).
RESELLER_ID	1-11	uint	Internal ID of the reseller which the event belongs to. <i>PLEASE NOTE: Only available in system exports, not for resellers.</i>

Table 13: (continued)

Body Element	Length	Type	Description
<line_terminator>	1	string	A fixed character. Always \n (special char LF - ASCII 0x0A).

A valid example of one body line of an EDR is (line breaks added for clarity):

```
"1", "start_profile", "sipwise_ext_customer_id_4", "Sipwise GmbH",
"sipwise_ext_subscriber_id_44", "436667778", "", "1", "2014-06-19 11:34:31", "1"
```

The format of the **EDR export files generated for resellers** (as opposed to the complete system-wide export) is identical except for a few missing fields.

Note

Please check the description of fields in the table above, in order to see which fields are omitted for *reseller* related EDR exports.

The list of fields for *reseller* EDR export is defined in `/etc/ngcp-config/config.yml` file, `eventexport.reseller_export` parameter.

9.4.3.6 Extra fields that can be exported to EDRs

There are fields in EDR database that contain **supplementary data** related to subscribers, for example subscriber phone numbers are such data.

Table 14: Supplementary data in EDR fields

Body Element	Length	Type	Description
SUBSCRIBER_PROFILE_SET_NAME	0-255	string	The subscriber's profile set name.
PILOT_SUBSCRIBER_PROFILE_SET_NAME	0-255	string	The profile set name of the subscriber's pilot subscriber.
PILOT_SUBSCRIBER_PROFILE_NAME	0-255	string	The profile name of the subscriber's pilot subscriber.
FIRST_NON_PRIMARY_ALIAS_USER_NAME_BEFORE	0-255	string	The subscriber's non-primary alias with lowest ID, before number updates during the operation.
FIRST_NON_PRIMARY_ALIAS_USER_NAME_AFTER	0-255	string	The subscriber's non-primary alias with lowest ID, after number updates during the operation.
PILOT_FIRST_NON_PRIMARY_ALIAS_USER_NAME_BEFORE	0-255	string	The non-primary alias with lowest ID of the subscriber's pilot subscriber, before number updates during the operation.

Table 14: (continued)

Body Element	Length	Type	Description
PILOT_FIRST_NON_PRIMARY_ALIAS_USERNAME_AFTER	0-255	string	The non-primary alias with lowest ID of the subscriber's pilot subscriber, after number updates during the operation.
NON_PRIMARY_ALIAS_USERNAME	0-255	string	The non-primary alias of a subscriber affected by an <code>update_profile</code> , <code>start_profile</code> or <code>end_profile</code> event to track number changes.
PRIMARY_ALIAS_USERNAME_BEFORE	0-255	string	The subscriber's primary alias, before number updates during the operation.
PRIMARY_ALIAS_USERNAME_AFTER	0-255	string	The subscriber's primary alias, after number updates during the operation.
PILOT_PRIMARY_ALIAS_USERNAME_BEFORE	0-255	string	The primary alias of the subscriber's pilot subscriber, before number updates during the operation.
PILOT_PRIMARY_ALIAS_USERNAME_AFTER	0-255	string	The primary alias of the subscriber's pilot subscriber, after number updates during the operation.
FIRST_NON_PRIMARY_ALIAS_USERNAME_BEFORE	0-255	string	Equals <code>FIRST_NON_PRIMARY_ALIAS_USERNAME_BEFORE</code> , if the value is not NULL, otherwise it's the same as <code>FIRST_NON_PRIMARY_ALIAS_USERNAME_AFTER</code> .
PILOT_FIRST_NON_PRIMARY_ALIAS_USERNAME_BEFORE	0-255	string	Equals <code>PILOT_FIRST_NON_PRIMARY_ALIAS_USERNAME_BEFORE</code> , if the value is not NULL, otherwise it's the same as <code>PILOT_FIRST_NON_PRIMARY_ALIAS_USERNAME_AFTER</code> .

9.4.3.7 File Trailer Format

The billing file trailer is one single line, which is constructed by the following fields:

<md5 sum>

The <md5 sum> is a 32 character hexadecimal MD5 hash of the *Header* and *Body*.

To validate the billing file, one must remove the Trailer before computing the MD5 sum of the file. The `ngcp-cdr-md5` program included in the `ngcp-cdr-exporter` package can be used to validate the integrity of the file.

Given a CDR-file named as `sipwise_001_20071110123000_0000000004.cdr`, the output of the integrity check for an intact CDR file would be:

```
$ ngcp-cdr-md5 sipwise_001_20071110123000_0000000004.cdr
/tmp/ngcp-cdr-md5.sipwise_001_20071110123000_0000000004.cdr.oqkd4P2zXI: OK
```

If the file has been altered during transmission, the output of the integrity check would be:

```
$ ngcp-cdr-md5 sipwise_001_20071110123000_0000000004.cdr
/tmp/ngcp-cdr-md5.sipwise_001_20071110123000_0000000004.cdr.hUtuhtKE1: FAILED
md5sum: WARNING: 1 of 1 computed checksum did NOT match
```

9.4.4 File Transfer

Billing files are created twice per hour at minutes 25 and 55 and are stored in the home directory of the `cdrexp` user. If the amount of records within the transmission interval exceeds the threshold of 5000 records per file, multiple billing files are created. If no billing records are found for an interval, a billing file without body data is constructed for easy detection of lost billing files on the 3rd party side.

CDR and EDR files are fetched by a 3rd party billing system using SFTP or SCP with either public key or password authentication using the username `cdrexp`.

If public key authentication is chosen, the public key file has to be stored in the file `~/.ssh/authorized_keys2` below the home directory of the `cdrexp` user. Otherwise, a password has to be set for the user.

The 3rd party billing system is responsible for deleting CDR files after fetching them.

Note

The `cdrexp` user is kept in a jailed environment on the system, so it has only access to a very limited set of commandline utilities.

10 Provisioning REST API Interface

The Sipwise C5 provides the REST API interface for interconnection with 3rd party tools.

The Sipwise C5 provides a REST API to provision various functionality of the platform. The entry point - and at the same time the official documentation - is at <https://<your-ip>:1443/api>. It allows both administrators and resellers (in a limited scope) to manage the system.

You can either authenticate via username and password of your administrative account you're using to access the admin panel, or via SSL client certificates. Find out more about client certificate authentication in the online API documentation.

10.1 API Workflows for Customer and Subscriber Management

The typical tasks done on the API involve managing customers and subscribers. The following chapter focuses on creating, changing and deleting these resources.

The standard life cycle of a customer and subscriber is:

1. Create customer contact
2. Create customer
3. Create subscribers within customer
4. Modify subscribers
5. Modify subscriber preferences (features)
6. Terminate subscriber
7. Terminate customer

The boiler-plate to access the REST API is described in the online API documentation at [/api/#auth](#). A simple example in Perl using password authentication looks as follows:

```
#!/usr/bin/perl -w
use strict;
use v5.10;

use LWP::UserAgent;
use JSON qw();

my $uri = 'https://ngcp.example.com:1443';
my $ua = LWP::UserAgent->new;
my $user = 'myusername';
my $pass = 'mypassword';
$ua->credentials('ngcp.example.com:1443', 'api_admin_http', $user, $pass);
my ($req, $res);
```

For each customer you create, you need to assign a billing profile id. You either have the ID stored somewhere else, or you need to fetch it by searching for the billing profile handle.

```
my $billing_profile_handle = 'my_test_profile';
$req = HTTP::Request->new('GET', "$uri/api/billingprofiles/?handle=$billing_profile_handle" <->
);
$res = $ua->request($req);
if($res->code != 200) {
    die "Failed to fetch billing profile: ".$res->decoded_content."\n";
}
my $billing_profile = JSON::from_json($res->decoded_content);
my $billing_profile_id = $billing_profile->{_embedded}->{'ngcp:billingprofiles'}->{id};
say "Fetched billing profile, id is $billing_profile_id";
```

A customer is mainly a billing container for subscribers without a real identification other than the *external_id* property you might have stored somewhere else (e.g. the ID of the customer in your CRM). To still easily identify a customer, a customer contact is required. It is created using the */api/customercontacts/* resource.

```
$req = HTTP::Request->new('POST', "$uri/api/customercontacts/");
$req->header('Content-Type' => 'application/json');
$req->content(JSON::to_json({
    firstname => 'John',
    lastname => 'Doe',
    email => 'john.doe@example.com'
}));
$res = $ua->request($req);
if($res->code != 201) {
    die "Failed to create customer contact: ".$res->decoded_content."\n";
}
my $contact_id = $res->header('Location');
$contact_id =~ s/^.+\/(\d+)\$\/$1/; # extract the ID from the Location header
say "Created customer contact, id is $contact_id";
```



Important

To get the ID of the recently created resource, you need to parse the *Location* header. In future, this approach will be changed for POST requests. The response will also optionally return the ID of the resource. It will be controlled via the *Prefer: return=representation* header as it is already the case for PUT and PATCH.



Warning

The example above implies the fact that you access the API via a reseller user. If you are accessing the API as the admin user, you also have to provide a *reseller_id* parameter defining the reseller this contact belongs to.

Once you have created the customer contact, you can create the actual customer.

```
$req = HTTP::Request->new('POST', "$uri/api/customers/");
$req->header('Content-Type' => 'application/json');
$req->content(JSON::to_json({
    status => 'active',
    contact_id => $contact_id,
    billing_profile_id => $billing_profile_id,
    type => 'sipaccount',
    external_id => undef, # can be set to your crm's customer id
}));
$res = $ua->request($req);
if($res->code != 201) {
    die "Failed to create customer: ".$res->decoded_content."\n";
}
my $customer_id = $res->header('Location');
$customer_id =~ s/^.+\/(\d+)$\/$1/; # extract the ID from the Location header
say "Created customer, id is $customer_id";
```

Once you have created the customer, you can add subscribers to it. One customer can hold multiple subscribers, up to the *max_subscribers* property which can be set via */api/customers/*. If this property is not defined, a virtually unlimited number of subscribers can be added.

```
$req = HTTP::Request->new('POST', "$uri/api/subscribers/");
$req->header('Content-Type' => 'application/json');
$req->content(JSON::to_json({
    status => 'active',
    customer_id => $customer_id,
    primary_number => { cc => 43, ac => 9876, sn => 10001 }, # the main number
    alias_numbers => [ # as many alias numbers the subscriber can be reached at (or skip ←
        param if none)
        { cc => 43, ac => 9877, sn => 10001 },
        { cc => 43, ac => 9878, sn => 10001 }
    ],
    username => 'test_10001'
    domain => 'ngcp.example.com',
    password => 'secret subscriber pass',
    webusername => 'test_10001',
    webpassword => undef, # set undef if subscriber shouldn't be able to log into sipwise ←
        csc
    external_id => undef, # can be set to the operator crm's subscriber id
}));
$res = $ua->request($req);
if($res->code != 201) {
    die "Failed to create subscriber: ".$res->decoded_content."\n";
```

```

}
my $subscriber_id = $res->header('Location');
$subscriber_id =~ s/^.+\//(\d+)\$/1/; # extract the ID from the Location header
say "Created subscriber, id is $subscriber_id";

```

**Important**

A domain must exist before creating a subscriber. You can create the domain via `/api/domains/`.

At that stage, the subscriber can connect both via SIP and XMPP, and can be reached via the primary number, all alias numbers, as well as via the SIP URI.

If you want to set call forwards for the subscribers, then perform an API call as follows.

```

$req = HTTP::Request->new('PUT', "$uri/api/callforwards/$subscriber_id");
$req->header('Content-Type' => 'application/json');
$req->header('Prefer' => "return=minimal"); # use return=representation to get full json ←
      response
$req->content(JSON::to_json({
  cfna => { # set a call-forward if subscriber is not registered
    destinations => [
      { destination => "4366610001", timeout => 10 }, # ring this for 10s
      { destination => "4366710001", timeout => 300 }, # if no answer, ring that for ←
        300s
    ],
    times => undef # no time-based call-forward, trigger cfna always
  }
}));
$res = $ua->request($req);
if($res->code != 204) { # if return=representation, it's 200
  die "Failed to set cfna for subscriber: ".$res->decoded_content."\n";
}

```

You can set cfu, cfna, cfb, cft, cfs and cfr via this API call, also all at once. Destinations can be hunting lists as described above or just a single number. Also, a time set can be provided to trigger call forwards only during specific time periods.

To provision certain features of a subscriber, you can manipulate the subscriber preferences. You can find a full list of preferences available for a subscriber at `/api/subscriberpreferencedefs/`.

```

$req = HTTP::Request->new('GET', "$uri/api/subscriberpreferences/$subscriber_id");
$res = $ua->request($req);
if($res->code != 200) {
  die "Failed to fetch subscriber preferences: ".$res->decoded_content."\n";
}

```

```

}
my $prefs = JSON::from_json($res->decoded_content);
delete $prefs->{_links}; # not needed in update

$prefs->{prepaid_library} = 'libinewrate'; # switch to inew billing
$prefs->{block_in_clir} = JSON::true; # reject incoming anonymous calls
$prefs->{block_in_list} = [ # reject calls from the following numbers:
    '4366412345', # this particular number
    '431*', # all vienna/austria numbers
];
$req = HTTP::Request->new('PUT', "$uri/api/subscriberpreferences/$subscriber_id");
$req->header('Content-Type' => 'application/json');
$req->header('Prefer' => "return=minimal"); # use return=representation to get full json ←
    response
$req->content(JSON::to_json($prefs));
$res = $ua->request($req);
if($res->code != 204) {
    die "Failed to update subscriber preferences: ".$res->decoded_content."\n";
}
say "Updated subscriber preferences";

```

Modifying numbers assigned to a subscriber, changing the password, locking a subscriber, etc. can be done directly on the subscriber resource.

```

$req = HTTP::Request->new('GET', "$uri/api/subscribers/$subscriber_id");
$res = $ua->request($req);
if($res->code != 200) {
    die "Failed to fetch subscriber: ".$res->decoded_content."\n";
}
my $sub = JSON::from_json($res->decoded_content);
delete $sub->{_links}; # not needed in update
push @{$sub->{alias_numbers}}, { cc => 1, ac => 5432, sn => $t }; # add this number
push @{$sub->{alias_numbers}}, { cc => 1, ac => 5433, sn => $t }; # add another number

$req = HTTP::Request->new('PUT', "$uri/api/subscribers/$subscriber_id");
$req->header('Content-Type' => 'application/json');
$req->header('Prefer' => "return=minimal"); # use return=representation to get full json ←
    response
$req->content(JSON::to_json($sub));
$res = $ua->request($req);
if($res->code != 204) {
    die "Failed to update subscriber: ".$res->decoded_content."\n";
}
say "Updated subscriber";

```

At the end of a subscriber life cycle, it can be terminated. Once terminated, you can NOT recover the subscriber anymore.

```

$req = HTTP::Request->new('DELETE', "$uri/api/subscribers/$subscriber_id");
$res = $ua->request($req);
if($res->code != 204) {
    die "Failed to terminate subscriber: ".$res->decoded_content."\n";
}
say "Terminated subscriber";

```

Note that certain information is still available in the internal database to perform billing/rating of calls done by this subscriber. Nevertheless, the data is removed from the operational tables of the database, so the subscriber is not able to connect to the system, login or make calls/chats.

Resources modification can be done via the GET/PUT combination. Alternatively, you can add, modify or delete single properties of a resource without actually fetching the whole resource. See an example below where we terminate the status of a customer using the PATCH method.

```

$req = HTTP::Request->new('PATCH', "$uri/api/customers/$customer_id");
$req->header('Content-Type' => 'application/json-patch+json');
$req->header('Prefer' => "return=minimal"); # use return=representation to get full json ↔ response
$req->content(JSON::to_json([
    { op => 'replace', path => '/status', value => 'terminated' }
]));
$res = $ua->request($req); # this will also terminate all still active subscribers
if($res->code != 204) {
    die "Failed to terminate customer: ".$res->decoded_content."\n";
}
say "Terminated customer";

```

10.2 API performance considerations

The REST API is designed with pagination support built-in. It is mandatory, to implement pagination in your API clients. If you circumvent pagination by setting the number of rows requested in one API call to a very high number the following side effects may appear:

1. An HTTP timeout at the gateway may occur. The default timeout limit is set to 60s. You can change it by creating a patchtt file for the following template: */etc/ngcp-config/templates/etc/nginx/sites-available/ngcp-panel_admin_api.tt2*.
2. Other parts of the system might become unresponsive due to mysql table locks. This especially applies to endpoints related to the Customers entity.

11 Configuration Framework

The Sipwise C5 provides a configuration framework for consistent and easy to use low level settings management. A basic usage of the configuration framework only needs two actions already used in previous chapters:

- Edit `/etc/ngcp-config/config.yml` file.
- Execute `ngcpcfg apply 'my commit message'` command.

Low level management of the configuration framework might be required by advanced users though. This chapter explains the architecture and usage of Sipwise C5 configuration framework. If the basic usage explained above fits your needs, feel free to skip this chapter and return to it when your requirements change.

A more detailed workflow of the configuration framework for creating a configuration file consists of 7 steps:

- Generation or editing of configuration templates and/or configuration values.
- Generation of the configuration files based on configuration templates and configuration values defined in `config.yml`, `constants.yml` and `network.yml` files.
- Execution of `prebuild` commands if defined for a particular configuration file or configuration directory.
- Placement of the generated configuration file in the target directory. This step is called `build` in the configuration framework.
- Execution of `postbuild` commands if defined for that configuration file or configuration directory.
- Execution of `services` commands if defined for that configuration file or configuration directory. This step is called `services` in the configuration framework.
- Saving of the generated changes. This step is called `commit` in the configuration framework.

11.1 Configuration templates

The Sipwise C5 provides configuration file templates for most of the services it runs. These templates are stored in the directory `/etc/ngcp-config/templates`.

Example: Template files for `/etc/ngcp-sems/sems.conf` are stored in `/etc/ngcp-config/templates/etc/ngcp-sems/`.

There are different types of files in this template framework, which are described below.

11.1.1 `.tt2`, `.customtt.tt2` and `.patchtt.tt2` files

These files are the main template files that will be used to generate the final configuration file for the running service. They contain all the configuration options needed for a running Sipwise C5 system. The configuration framework will combine these files with the values provided by `config.yml`, `constants.yml` and `network.yml` to generate the appropriate configuration file.

Example: Let's say we are changing the IP used by kamailio load balancer on interface *eth0* to IP 1.2.3.4. This will change kamailio's listen IP address, when the configuration file is generated. A quick look to the template file under */etc/ngcp-config/templates/etc/kamailio* will show a line like this:

```
listen=udp:[% ip %]:[% kamailio.lb.port %]
```

After applying the changes with the *ngcpconfig apply 'my commit message'* command, a new configuration file will be created under */etc/kamailio/lb/kamailio.cfg* with the proper values taken from the main configuration files (in this case *network.yml*):

```
listen=udp:1.2.3.4:5060
```

All the low-level configuration is provided by these *.tt2* template files and the corresponding *config.yml* file. Anyway, advanced users might require a more particular configuration.

Instead of editing *.tt2* files, the configuration framework recognises *.customtt.tt2* files. These files are the same as *.tt2*, but they have higher priority when the configuration framework creates the final configuration files. If you need to introduce changes in a template, you must always copy the required *.tt2* file to *.customtt.tt2*, make changes in the latter file one and leave the *.tt2* file untouched. This way, the system will use the new custom configuration allowing you to switch back to the original one quickly.

Example: We'll create */etc/ngcp-config/templates/etc/lb/kamailio.cfg.customtt.tt2* and use it for our customized configuration. In this example, we'll just append a comment at the end of the template.

```
cd /etc/ngcp-config/templates/etc/kamailio/lb
cp kamailio.cfg.tt2 kamailio.cfg.customtt.tt2
echo '# This is my last line comment' >> kamailio.cfg.customtt.tt2
ngcpconfig apply 'my commit message'
```

The *ngcpconfig* command will generate */etc/kamailio/lb/kamailio.cfg* from our custom template instead of the general one:

```
tail -1 /etc/kamailio/lb/kamailio.cfg
# This is my last line comment
```

**Warning**

users have to upgrade all *.customtt.tt2* manually every time *.tt2* is upgraded, as *ngcpconfig* completely ignores new code in *.tt2* received from new package version.

The huge drawback of *.customtt.tt2* files are necessity to keep them up-to-date manually. Keeping them outdated will cause the system misbehaviour as different components will use different code version (as new *.tt2* version will be overwritten by old *.customtt.tt2*).

The `.patchtt.tt2` concept should help users here. It will minimise the manual efforts by using linux "patch" utility. The `ngcpcfg` tool is searching for `.patchtt.tt2` files every time `ngcpcfg build` has been called. If `.patchtt.tt2` is detected, the `ngcpcfg` tool will try to apply `.patchtt.tt2` on `.tt2` and store result in `.customtt.tt2` if no conflicts noticed during patching. Further building process happens in a common way. Example:

```
root@spce:~# ngcpcfg build /etc/kamailio/lb/kamailio.cfg
spce: yml configs were validated successfully
spce: configs were checked successfully
spce: Validating patch '/etc/ngcp-config/templates/etc/kamailio/lb/kamailio.cfg.patchtt.tt2'
spce: Applying patch '/etc/ngcp-config/templates/etc/kamailio/lb/kamailio.cfg.patchtt.tt2'
spce: Successfully created '/etc/ngcp-config/templates/etc/kamailio/lb/kamailio.cfg.customtt.tt2'
spce: Requested patchtt operation has finished successfully.
Loading /etc/ngcp-config/config.yml in memory: OK
Loading /etc/ngcp-config/network.yml in memory: OK
Loading /etc/ngcp-config/constants.yml in memory: OK
spce: Generating /etc/kamailio/lb/kamailio.cfg: OK
spce: Executing postbuild for /etc/kamailio/lb/kamailio.cfg
root@spce:~#
```

To convert some/all the current `.customtt.tt2` users can use command `ngcpcfg patch --from-customtt [<customtt_file>]`:

```
root@spce:~# ngcpcfg patch --from-customtt /etc/ngcp-config/templates/etc/kamailio/lb/
kamailio.cfg.customtt.tt2
spce: Validating customtt '/etc/ngcp-config/templates/etc/kamailio/lb/kamailio.cfg.customtt
.tt2'
spce: Creating patchtt file '/etc/ngcp-config/templates/etc/kamailio/lb/kamailio.cfg.
patchtt.tt2'
spce: Requested customtt operation has finished successfully.
root@spce:~#
```

Here is the example of newly created `.patchtt.tt2` file:

```
root@spce:~# cat /etc/ngcp-config/templates/etc/kamailio/lb/kamailio.cfg.patchtt.tt2
@@ -1799,3 +1799,4 @@
}

# vim: ft=cfg
+# This is my last line comment
root@spce:~#
```

See more details about `.patchtt.tt2` files below in [patchtt](#) section.

Tip

The .tt2 files use the **Template Toolkit** language. Therefore you can use all the feature this excellent toolkit provides within ngcpcfg's template files (all the ones with the .tt2 suffix).

11.1.2 Using patchtt for generation of a relevant customtt file

Keeping custom modifications directly in the .customtt.tt2 templates is NOT recommended as templates become outdated with every software upgrade.

A better way is to handle custom modifications using .patchtt.tt2 files (e.g. /etc/ngcp-config/templates/etc/cron.d/cleanup-tools.patchtt.tt2). In this case, on every "ngcpcfg patch", a .patchtt.tt2 file will be applied on top of the .tt2 file and the result will be saved into the customtt file and used commonly as described in the previous section. "ngcpcfg patch" is the first step on "ngcpcfg build" that guarantees the latest upstream templates with the availability of the necessary local changes on every configuration apply.

Tip

The patch to be applied to the corresponding .tt2 template file is selected in the following order (highest to lowest):
*.patchtt.tt2.\$HOSTNAME *.patchtt.tt2.\$PAIRNAME *.patchtt.tt2.\$HA_NODE *.patchtt.tt2

Note

If a suitable patchtt file is found for a template, then the ngcpcfg patch command will overwrite the corresponding customtt file, if any.

11.1.2.1 Creating a patchtt file

Let us see how to introduce custom changes into a template through a patchtt file. For example, we need to change the accounting records cleanup time, which is defined in *cleanup-tools.tt2*. Here is how to do this:

- Go to the corresponding templates directory:

```
cd /etc/ngcp-config/templates/etc/cron.d/
```

- Duplicate the required .tt2 file to .customtt.tt2

```
cp ./cleanup-tools.tt2 ./cleanup-tools.customtt.tt2
```

- Introduce the necessary changes to the duplicated file:

```
vim ./cleanup-tools.customtt.tt2
```

- Create the patchtt file from your customtt file and recheck it:

```
ngcpcfg patch --from-customtt ./cleanup-tools.customtt.tt2
cat ./cleanup-tools.patchtt.tt2
```

- Apply and push the changes

```
ngcpcfg apply "Change acc-cleanup time from 00 to 02 hours"
ngcpcfg push all
```

You will notice that the "ngcpcfg apply" command has generated the customtt file for the corresponding template:

```
root@web01a:/etc/ngcp-config/templates/etc/cron.d# ls -l ./cleanup-tools*
-rw----- 1 root root 932 Jan  4 11:11 ./cleanup-tools.customtt.tt2
-rw-r--r-- 1 root root 630 Jan  4 11:08 ./cleanup-tools.patchtt.tt2
-rw-r--r-- 1 root root 932 Dec 18 15:09 ./cleanup-tools.tt2
```

Now, even if cleanup-tools.tt2 slightly changes after a software upgrade, "ngcpcfg apply" will still preserve your custom changes.

Note

If in a new release the .tt2 file gets changed in the same lines where you had introduced custom changes (e.g. your changes were temporary until a feature is implemented properly in a new software release), the apply process will fail and ask you to review the corresponding .patchtt.tt2 file. Then, check it and either correct if it is still required or remove it.

Tip

To convert all existing customtt files to patchtt files use the command: **ngcpcfg patch --from-customtt**

11.1.3 .prebuild and .postbuild files

After creating the configuration files, the configuration framework can execute some commands before and after placing that file in its target directory. These commands usually are used for changing the file's owner, groups, or any other attributes. There are some rules these commands need to match:

- They have to be placed in a *.prebuild* or *.postbuild* file in the same path as the original *.tt2* file.

- The file name must be the same as the configuration file, but having the mentioned suffixes.
- The commands must be *bash* compatible.
- The commands must return 0 if successful.
- The target configuration file is matched by the environment variable *output_file*.

Example: We need *www-data* as owner of the configuration file */etc/ngcp-ossbss/provisioning.conf*. The configuration framework will by default create the configuration files with *root:root* as owner:group and with the same permissions (*rwX*) as the original template. For this particular example, we will change the owner of the generated file using the *.postbuild* mechanism.

```
echo 'chgrp www-data ${output_file}' \  
> /etc/ngcp-config/templates/etc/ngcp-ossbss/provisioning.conf.postbuild
```

11.1.4 .services files

.services files are pretty similar and might contain commands that will be executed after the *build* process. There are two types of *.services* files:

- The particular one, with the same name as the configuration file it is associated to.
Example: */etc/ngcp-config/templates/etc/asterisk/sip.conf.services* is associated to */etc/asterisk/sip.conf*
- The general one, named *ngcpcfg.services* that is associated to every file in its target directory.
Example: */etc/ngcp-config/templates/etc/asterisk/ngcpcfg.services* is associated to every file under */etc/asterisk/*

When the *services* step is triggered all *.services* files associated to a changed configuration file will be executed. In case of the general file, any change to any of the configuration files in the directory will trigger the execution of the commands.

Tip

If the service script has the execute flags set (*chmod +x \$file*) it will be invoked directly. If it doesn't have execute flags set it will be invoked under *bash*. Make sure the script is *bash* compatible if you do not set execute permissions on the service file.

These commands are usually service reload/restarts to ensure the new configuration has been loaded by running services.

Note

The configuration files mentioned in the following example usually already exist on the platform. Please make sure you don't overwrite any existing files if following this example.

Example:

```
echo 'ngcp-service mariadb restart' \  
> /etc/ngcpcfg-config/templates/etc/mysql/my.cnf.services  
echo 'ngcp-service asterisk restart' \  
> /etc/ngcpcfg-config/templates/etc/asterisk/ngcpcfg.services
```

In this example we created two `.services` files. Now, each time we trigger a change to `/etc/mysql/my.cnf` or to `/etc/asterisk/*` we'll see that MySQL or Asterisk services will be restarted by the `ngcpcfg` system.

11.2 config.yml, constants.yml and network.yml files

The `/etc/ngcp-config/config.yml` file contains all the user-configurable options, using the **YAML** (YAML Ain't Markup Language) syntax.

The `/etc/ngcp-config/constants.yml` file provides configuration options for the platform that aren't supposed to be edited by the user. Do not manually edit this file unless you really know what you're doing.

The `/etc/ngcp-config/network.yml` file provides configuration options for all interfaces and IP addresses on those interfaces. You can use the `ngcp-network` tool for conveniently change settings without having to manually edit this file.

The `/etc/ngcp-config/ngcpcfg.cfg` file is the main configuration file for `ngcpcfg` itself. Do not manually edit this file unless you really know what you're doing.

11.3 ngcpcfg and its command line options

The `ngcpcfg` utility supports the following command line options:

11.3.1 apply

The `apply` option is a short-cut for the options "check && build && services && commit" and also executes `etckeeper` to record any modified files inside `/etc`. It is the recommended option to use the `ngcpcfg` framework unless you want to execute any specific commands as documented below.

11.3.2 build

The `build` option generates (and therefore also updates) configuration files based on their configuration (`config.yml`) and template files (`.tt2`). Before the configuration file is generated a present `.prebuild` will be executed, after generation of the configuration file the according `.postbuild` script (if present) will be executed. If a `file` or `directory` is specified as argument the build will generate only the specified configuration file/directory instead of running through all present templates.

Example: to generate only the file `/etc/nginx/sites-available/ngcp-panel` you can execute:

```
ngcpcfg build /etc/nginx/sites-available/ngcp-panel
```

Example: to generate all the files located inside the directory `/etc/nginx/` you can execute:

```
ngcpcfg build /etc/nginx/
```

11.3.3 commit

The *commit* option records any changes done to the configuration tree inside `/etc/ngcp-config`. The *commit* option should be executed when you've modified anything inside the configuration tree.

11.3.4 decrypt

Decrypt `/etc/ngcp-config-encrypted.tgz.gpg` and restore configuration files, doing the reverse operation of the *encrypt* option. Note: This feature is only available if the `ngcp-ngcpcfg-locker` package is installed.

11.3.5 diff

Show uncommitted changes between `ngcpcfg`'s Git repository and the working tree inside `/etc/ngcp-config`. If the tool doesn't report anything it means that there are no uncommitted changes. If the `--addremove` option is specified then new and removed files (iff present) that are not yet (un)registered to the repository will be reported, no further diff actions will be executed then. Note: This option is available since `ngcp-ngcpcfg` version 0.11.0.

11.3.6 encrypt

Encrypt `/etc/ngcp-config` and all resulting configuration files with a user defined password and save the result as `/etc/ngcp-config-encrypted.tgz.gpg`. Note: This feature is only available if the `ngcp-ngcpcfg-locker` package is installed.

11.3.7 help

The *help* options displays `ngcpcfg`'s help screen and then exits without any further actions.

11.3.8 initialise

The *initialise* option sets up the `ngcpcfg` framework. This option is automatically executed by the installer for you, so you shouldn't have to use this option in normal operations mode.

11.3.9 pull

Retrieve modifications from shared storage. Note: This option is available in the High Availability setup only.

11.3.10 push

Push modifications to shared storage and remote systems. After changes have been pushed to the nodes the *build* option will be executed on each remote system to rebuild the configuration files (unless the *--nobuild* has been specified, then the build step will be skipped). If hostname(s) or IP address(es) is given as argument then the changes will be pushed to the shared storage and to the given hosts only. If no host has been specified then the hosts specified in */etc/ngcp-config/systems.cfg* are used. Note: This option is available in the High Availability setup only.

11.3.11 services

The *services* option executes the service handlers for any modified configuration file(s)/directory.

11.3.12 status

The *status* option provides a human readable interface to check the state of the configuration tree. If you are unsure what should be done as next step or if want to check the current state of the configuration tree just invoke *ngcpcfg status*.

If everything is OK and nothing needs to be done the output should look like:

```
# ngcpcfg status
Checking state of ngcpcfg:
OK:  has been initialised already (without shared storage)
Checking state of configuration files:
OK:  nothing to commit.
Checking state of /etc files
OK:  nothing to commit.
```

If the output doesn't say "OK" just follow the instructions provided by the output of *ngcpcfg status*.

Further details regarding the *ngcpcfg* tool are available through *man ngcpcfg* on the Sipwise Next Generation Platform.

12 Network Configuration

Starting with version 2.7, Sipwise C5 uses a dedicated *network.yml* file to configure the IP addresses of the system. The reason for this is to be able to access all IPs of all nodes for all services from any particular node in case of a distributed system on one hand, and in order to be able to generate */etc/network/interfaces* automatically for all nodes based on this central configuration file.

12.1 General Structure

The basic structure of the file looks like this:

```
hosts:
  self:
    role:
      - proxy
      - lb
      - mgmt
    interfaces:
      - eth0
      - lo
    eth0:
      ip: 192.168.51.213
      netmask: 255.255.255.0
      type:
        - sip_ext
        - rtp_ext
        - web_ext
        - web_int
    lo:
      ip: 127.0.0.1
      netmask: 255.255.255.0
      type:
        - sip_int
        - ha_int
```

Some more complete, sample configuration is shown in [network.yml Overview](#) section of the handbook.

The file contains all configuration parameters under the main key: `hosts`

In Sipwise C5 systems there is only one host entry in the file, and it's always named *self*.

12.1.1 Available Host Options

There are three different main sections for a host in the config file, which are *role*, *interfaces* and the actual interface definitions.

- *role*: The role setting is an array defining which logical roles a node will act as. Possible entries for this setting are:
 - *mgmt*: This entry means the host is acting as management node for the platform. In a Sipwise C5 system this option must always be set. The management node exposes the admin and CSC panels to the users and the APIs to external applications and is used to export CDRs.
 - *lb*: This entry means the host is acting as SIP load-balancer for the platform. In a Sipwise C5 system this option must always be set. The SIP load-balancer acts as an ingress and egress point for all SIP traffic to and from the platform.
 - *proxy*: This entry means the host is acting as SIP proxy for the platform. In a Sipwise C5 system this option must always be set. The SIP proxy acts as registrar, proxy and application server and media relay, and is responsible for providing the features for all subscribers provisioned on it.
 - *db*: This entry means the host is acting as the database node for the platform. In a Sipwise C5 system this option must always be set. The database node exposes the MySQL and Redis databases.
 - *rtp*: This entry means the host is acting as the RTP relay node for the platform. In a Sipwise C5 system this option must always be set. The RTP relay node runs the *rtpengine* Sipwise C5 component.
- *interfaces*: The interfaces setting is an array defining all interface names in the system. The actual interface details are set in the actual interface settings below. It typically includes `lo`, `eth0`, `eth1` physical and a number of virtual interfaces, like: `bond0`, `vlanXXX`
- *<interface name>*: After the interfaces are defined in the *interfaces* setting, each of those interfaces needs to be specified as a separate set of parameters.

Additional main parameters of a node:

- *dbnode*: the sequence number (unique ID) of the node in the database cluster; not used in Sipwise C5 system
- *status*: one of *online*, *offline*, *inactive*. *inactive* means that the node is up but is not ready to work in the cluster (installing process). *offline* means that the node is not reachable. *online* is a normal working node.

12.1.2 Interface Parameters

- *hwaddr*: MAC address of the interface
- *ip*: IPv4 address of the node
- *v6ip*: IPv6 address of the node; optional
- *netmask*: IPv4 netmask
- *advertised_ip*: the IP address that is used in SIP messages when Sipwise C5 system is behind NAT/SBC. An example of such a deployment is *Amazon AMI*, where the server doesn't have a public IP, so *load-balancer* component of Sipwise C5 needs to know what his public domain is (→ *advertised_ip*).
- *type*: type of services that the node provides; these are usually the VLANs defined for a particular Sipwise C5 system.

Note

You can assign a type only once per node.

Available types are:

- `api_int`: internal, API-based communication interface. It is used for the internal communication of such services as faxserver, fraud detection and others.
- `aux_ext`: interface for potentially insecure external components like remote system log collection service.
- `mon_ext`: remote monitoring interface (e.g. SNMP)
- `rtp_ext`: main (external) interface for media traffic
- `sip_ext`: main (external) interface for SIP signalling traffic between NGCP and other SIP endpoints
- `sip_ext_incoming`: additional, optional interface for incoming SIP signalling traffic
- `sip_int`: internal SIP interface used by Sipwise C5 components (*lb, proxy, etc.*)
- `ssh_ext`: command line (SSH) remote access interface
- `web_ext`: interface for web-based or API-based provisioning and administration
- `web_int`: interface for the administrator's web panel, his API and generic internal API communication

Note

Please note that, apart from the standard ones described so far, there might be other *types* defined for a particular Sipwise C5 system.

- `vlan_raw_device`: tells which physical interface is used by the particular VLAN
- `post_up`: routes can be defined here (interface-based routing), for example:

```
post_up:
- route add -host 1.2.3.4 gw 192.168.1.1 dev vlan70
- route add -net 10.11.12.0/21 gw 192.168.1.2 dev vlan300
- route del -host 1.2.3.4 gw 192.168.1.1 dev vlan70
- route del -net 10.11.12.0/21 gw 192.168.1.2 dev vlan300
```

- `bond_XY`: specific to "bond0" interface only; these contain Ethernet bonding properties

12.2 Advanced Network Configuration

You have a typical deployment now and you are good to go, however you may need to do extra configuration depending on the devices you are using and functionality you want to achieve.

12.2.1 Additional entries in `/etc/hosts`

The file `/etc/hosts` is generated by a template, containing entries for basic host configuration (localhost and basic IPv4/IPv6), and the IPs of other nodes in Pro/Carrier configurations.

To add extra entries in this file, it can be done in several ways:

- `etc_hosts_global_extra_entries` at the global level, added to all hosts
- `etc_hosts_global_extra_entries` at the host level, which overrides the global one if for some reason the whole content is undesired for a particular host (e.g. to have some but not all of the "default" global entries)
- `etc_hosts_local_extra_entries` at the host level, which are added only to the hosts where this entry is present, if for some reason it is desired to have extra entries only visible in some subset of the hosts

The behaviour is the same in all cases, to append the entries directly to `/etc/hosts`.

Example of both in a configuration file:

```
---
hosts_common:
  etc_hosts_global_extra_entries:
  - 10.100.1.1 server-1 server-1.internal.example.com
  - 10.100.1.2 server-2 server-2.internal.example.com
hosts:
  db01b:
    etc_hosts_local_extra_entries:
    - 127.0.1.1 local-alias-1.db01b
    - 127.0.2.1 local-alias-2.db01b
    - 172.30.52.180 db01b.example.com
    ...
  web01a:
    etc_hosts_local_extra_entries:
    - 127.0.1.1 local-alias-1.web01a
    - 127.0.2.1 local-alias-2.web01a
    - 172.30.52.168 web01a.example.com
    etc_hosts_global_extra_entries:
    - 10.100.1.1 server-1 server-1.internal.example.com
    ...
```

With this, the additional output in `/etc/hosts` for `db01b` will be:

```
# local extra entries for host 'db01b'
127.0.1.1 local-alias-1.db01b
127.0.2.1 local-alias-2.db01b
172.30.52.180 db01b.example.com

# global extra entries
10.100.1.1 server-1 server-1.internal.example.com
10.100.2.1 server-2 server-2.internal.example.com
```

and in `web01a`:

```
# local extra entries for host 'web01a'
127.0.1.1 local-alias-1.web01a
127.0.2.1 local-alias-2.web01a
172.30.52.168 web01a.example.com

# global extra entries overridden for host 'web01a'
10.100.1.1 server-1 server-1.internal.example.com
```

12.2.2 Extra SIP Sockets

By default, the load-balancer listens on the UDP and TCP ports 5060 (*kamailio*→*lb*→*port*) and TLS port 5061 (*kamailio*→*lb*→*tls*→*port*). If you need to setup one or more extra SIP listening ports or IP addresses in addition to those standard ports, please edit the *kamailio*→*lb*→*extra_sockets* option in your */etc/ngcp-config/config.yml* file.

The correct format consists of a label and value like this:

```
extra_sockets:
  port_5064: udp:10.15.20.108:5064
  test: udp:10.15.20.108:6060
```

The label is shown in the `outbound_socket` peer preference (if you want to route calls to the specific peer out via specific socket); the value must contain a transport specification as in example above (udp, tcp or tls). After adding execute `ngcpcfg apply`:

```
ngcpcfg apply 'added extra socket'
```

The direction of communication through this SIP extra socket is incoming+outgoing. The Sipwise C5 will answer the incoming client registrations and other methods sent to the extra socket. For such incoming communication no configuration is needed. For the outgoing communication the new socket must be selected in the `outbound_socket` peer preference. For more details read the next section Section [12.2.3](#) that covers peer configuration for SIP and RTP in greater detail.



Important

In this section you have just added an extra SIP socket. RTP traffic will still use your *rtp_ext* IP address.

12.2.3 Extra SIP and RTP Sockets

If you want to use an additional interface (with a different IP address) for SIP signalling and RTP traffic you need to add your new interface in the */etc/network/interfaces* file. Also the interface must be declared in */etc/ngcp-config/network.yml*.

Suppose we need to add a new SIP socket and a new RTP socket on VLAN 100. You can use the *ngcp-network* tool for adding interfaces without having to manually edit this file:

```
ngcp-network --set-interface=eth0.100 --ip=auto --netmask=auto --hwaddr=auto --type= ↔
sip_ext_incoming --type=rtp_int_100
```

The generated file should look like the following:

```
..
..
  eth0.100:
    hwaddr: ff:ff:ff:ff:ff:ff
    ip: 192.168.1.3
    netmask: 255.255.255.0
    type:
      - sip_ext_incoming
      - rtp_int_100
..
..
  interfaces:
    - lo
    - eth0
    - eth0.100
    - eth1
..
..
```

As you can see from the above example, extra SIP interfaces must have type *sip_ext_incoming*. While *sip_ext* should be listed only once per host, there can be multiple *sip_ext_incoming* interfaces. The direction of communication through this SIP interface is incoming only. The Sipwise C5 will answer the incoming client registrations and other methods sent to this address and remember the interfaces used for clients' registrations to be able to send incoming calls to him from the same interface.

In order to use the interface for the outbound SIP communication it is necessary to add it to *extra_sockets* section in */etc/ngcp-config/config.yml* and select in the *outbound_socket* peer preference. So if using the above example we want to use the *vlan100* IP as source interface towards a peer, the corresponding section may look like the following:

```
extra_sockets:
  port_5064: udp:10.15.20.108:5064
  test: udp:10.15.20.108:6060
  int_100: udp:192.168.1.3:5060
```

The changes have to be applied:

```
ngcpcfg apply 'added extra SIP and RTP socket'
```

After applying the changes, a new SIP socket will listen on IP `192.168.1.3` and this socket can now be used as source socket to send SIP messages to your peer for example. In above example we used label `int_100`. So the new label "int_100" is now shown in the `outbound_socket` peer preference.

Also, RTP socket is now listening on `192.168.1.3` and you can choose the new RTP socket to use by setting parameter `rtp_interface` to the Label "int_100" in your Domain/Subscriber/Peer preferences.

12.2.4 Alternative RTP Interface Selection Using ICE

Normally, each interface that was configured with a type that starts with `rtp_` can be selected individually as RTP interface in the Domain/Subscriber/Peer preferences. For example, if the interface types `rtp_ext`, `rtp_int`, and `rtp_int_100` have been configured, the Domain/Subscriber/Peer preferences will allow the RTP interfaces to be selected as either `ext`, `int`, or `int_100` in addition to "default".

The same `rtp_` interface type can be configured on multiple interfaces. If this is the case, and if ICE (*Interactive Connectivity Establishment*) is enabled for a Domain/Subscriber/Peer, it is possible to use ICE to automatically negotiate which interface should be used for RTP communications. ICE must be supported by the remote client for this to work.

For example, `rtp_ext` can be configured on multiple interfaces like so (abbreviated):

```
..
..
  eth0.100:
    type:
      - rtp_ext
..
  eth0.150:
    type:
      - rtp_ext
..
  eth1:
    type:
      - rtp_ext
..
..
```

In this example, the RTP interface `ext` will be available for selection in the Domain/Subscriber/Peer preferences. If selected and if ICE is enabled, the addresses of all three interfaces will be presented to the remote client, and ICE will be used to negotiate which one of them will be used for communications. This can be useful in multi-homed environments, or when remote clients are on private networks.

12.2.5 Extended RTP Port Range Using Multiple Interfaces

If the RTP port range configured via the `config.yml` keys `rtpproxy.minport` and `rtpproxy.maxport` is not sufficient to handle all concurrent calls, it is possible to load-balance the RTP ports across multiple interfaces. This is useful if the RTP proxy runs out of ports and if not enough additional ports are available.

To enable this, multiple interfaces with different addresses must be configured, and interface types of the format `rtp_NAME:SUFFIX` must be assigned to them. For example, if the RTP interface named `ext` should be load-balanced across three interfaces, they can be configured like so (abbreviated):

```
..
..
  eth0.100:
    type:
      - rtp_ext:1
..
  eth0.150:
    type:
      - rtp_ext:2
..
  eth1:
    type:
      - rtp_ext:3
..
..
```

In this example, all three given RTP interface types will be available for selection in the Domain/Subscriber/Peer preferences individually (as `ext:1` and so on), but in addition to that, an interface named just `ext` will also be available for selection. If `ext` is selected, only one of the three RTP interfaces will be selected in a round-robin fashion, thus increasing the number of available RTP ports threefold. The round-robin algorithm only selects an interface if it actually has RTP ports available.

13 Licenses

The Sipwise C5—starting from mr5.5.1 release—implements *software licensing* primarily for the commercial products PRO and CARRIER. However as a CE platform operator you may also see a new process running on the system: "licensed". The only purpose of this software module is to collect anonymous statistics about the system usage, namely the following performance indicators are recorded:

- number of provisioned subscribers
- number of registered subscribers
- number of concurrent calls

The **anonymous usage statistics is enabled by default but you can disable it**. In order to do that you have to edit the main configuration file `/etc/ngcp-config/config.yml` and set `general.anonymous_usage_statistics` parameter to `no`. Then apply the new configuration with the usual command: `ngcpcfg apply "Disabled anon. usage stat"`

Tip

If Sipwise C5 operator does not want to have the license client package (`ngcp-license-client` and `ngcp-license-module`) on his system at all, it is possible to replace it with a dummy package: `ngcp-license-client-dummy`. This dummy package does not contain any licensing software, and is available from mr5.5.2 Sipwise C5 release.

14 Software Upgrade

14.1 Release Notes

The Sipwise C5 version mr7.5.1 has the following important changes:

- Upgrade from Debian 9 (stretch) to Debian 10 (buster) [TT#60950]
- Add LNP NCOS pattern filter (See Section 7.3.2.2 in the handbook to have more details) [TT#60903]
- Conversion of kamailio location records from datetime to timestamp format [TT#23358]
- Add support for tel:uri in inbound From and PAI headers [TT#61251]
- Rework and optimise the customer calls fraud control and notification logic [TT#51409]
- [Carrier] New feature *ngcpcfg push-parallel* to apply changes on all nodes in parallel [TT#63758]
- New ngcp-exporter component that exports active subscriber NCOS levels into .csv files [TT#62951]
- Upgrade Kamailio from version 5.1.6 to 5.2.3 [TT#56950]
- Upgrade MariaDB from version 10.1 to 10.3 [TT#60950]

Please find the complete changelog in our release notes [on our WEB site](#).

14.2 Overview

The Sipwise C5 software upgrade procedure to mr7.5.1 will perform several fundamental tasks:

- Upgrade the base system from Debian 9 (stretch) to Debian 10 (buster)
- upgrade the NGCP software packages
- upgrade the NGCP configuration templates
- upgrade the NGCP DB schema
- upgrade the NGCP configuration schema
- upgrade the base system within Debian 10 (buster) to the latest package versions

14.3 Preparing the software upgrade

It is recommended to execute the preparatory steps in this chapter a few days before the actual software upgrade. They do not cause a service downtime, so it is safe to execute them during peak hours.

14.3.1 Log into the C5 server

Run the terminal multiplexer under the *sipwise* user (to reuse the Sipwise `.screenrc` settings that are convenient for working in multiple windows):

```
screen -S my_screen_name_for_ngcp_upgrade
```

Become root inside your screen session:

```
sudo -s
```

14.3.2 Check the overall system status

Check the overall system status:

```
ngcp-status
```

14.3.3 Evaluate and update custom modifications

For the below steps, investigate and make sure you understand why the custom modifications were introduced and if they are still required after the software upgrade. If the custom modifications are not required anymore, remove them (e.g. if a bug was fixed in the target release and the existing patch becomes irrelevant).



Warning

If you directly change the working configuration (e.g. add custom templates or change the existing ones) for some reason, then the system must be thoroughly tested after these changes have been applied. Continue with the software upgrade preparation only if the results of the tests are acceptable.

Find the local changes to the template files:

```
ngcp-customtt-diff-helper
```

The script will also ask you if you would like to download the templates for your target release. To download the new templates separately, execute:

```
ngcp-customtt-diff-helper -d
```

In the tmp folder provided by the script, you can review the patchtt files or merge the current customtt with the new tt2 templates, creating the new customtt.tt2 files. Once you do this, archive the new patchtt/customtt files to reapply your custom modifications after the software upgrade:

```
ngcp-customtt-diff-helper -t
```

Find all available script options with the "-h" parameter.

Warning

Starting from version mr7.0.1 a new kamailio module called "pv_headers" has been introduced. This new module enables storing all headers in XAVP to freely modify them in the kamailio logic and only apply them once when it's time for the packet to be routed outside. The main goal of the module is to offload the intermediate header processing into the XAVP dynamic container as well as provide with high-level methods and pseudovars to simplify SIP message header modifications. The module is enabled by default in kamailio proxy and all the templates have been updated to use this new logic. Before proceeding with the upgrade it is essential that the customtt/patchtt you have in place are updated to this new format. At [appendix](#) you can find additional information on the module.

14.3.4 Check system integrity

Check if there are any *.tt2.dpkg-dist files among the templates. They usually appear when tt2 files are modified directly instead of creating customtt/patchtt files. If you find any *.tt2.dpkg-dist files, treat the corresponding tt2 files as if they were customtt.tt2 and introduce the changes from the existing tt2 files into the new templates (create associated customtt.tt2 or patchtt.tt2) before the software upgrade.

```
find /etc/ngcp-config -name \*.tt2.dpkg-dist
```

Note that in the end all *.tt2.dpkg-dist files must be removed before the software upgrade as they prevent the upgrade script from updating the tt2 files.

Check and remove dpkg files left from previous software upgrades.

Make sure that the list is empty before you continue:

```
find /etc/ngcp-config -name \*.tt2.dpkg\*
```

Changes made directly in tt2 templates will be lost after the software upgrade. Only custom changes made in customtt.tt2 or added by patchtt.tt2 files will be kept. Hence, check the system for locally modified tt2 files on **all** nodes:

```
ngcp-status --integrity
```

14.3.5 Check the configuration framework status

Check the configuration framework status on **all** nodes. All checks must show the "OK" result and there must be no actions required:

```
ngcpcfg status
```

Run "apt-get update" and ensure that you do not have any warnings and errors in the output.



Warning

If the installation uses locally specified mirrors, then the mirrors must be switched to the Sipwise APT repositories (at least for the software upgrade). Otherwise, the public Debian mirrors may not provide packages for old Releases anymore or at least provide outdated ones!

14.3.6 Check migration of location entries from Mysql to Redis DB



Warning

Upgrade to mr7.5 is allowed with kamailio.location in Redis DB only! It is necessary for the proper migration of location records from datetime to bigint/epoch.

Starting from mr6.2.1, location, acc and dialogs data are stored in RedisDB allowing better system performances. Before proceed with the upgrade, check if location data are already migrated to RedisDB:

```
ngcpcfg values "kamailio.proxy.redis.usrloc"
```

If the answer is *yes*, then skip this sub-chapter and proceed with the next one. On the contrary, an answer equals to *no* means that the migration process has not been completed. This happens because, to be more flexible and to reduce the downtime of the system, only acc and dialogs data have been moved automatically to RedisDB. Migration of location data is a step that should be done manually and it was probably skipped during previous upgrades.

To proceed with the migration and complete the process, execute the following commands **during out of business hours**:

- Enable location data storage on RedisDB:

```
ngcpcfg set /etc/ngcp-config/config.yml "kamailio.proxy.redis.usrloc=yes"
```

- Apply the changes to configuration templates:

```
ngcpcfg apply 'Enable location data storage on RedisDB'
```

- Migrate all location data from MySQL to Redis DB using an adhoc script:

```
ngcp-location-migrate -a
```

- Update the internal counters for accurate statistics about location entries: (This step can be executed any time location entries have been manually modified)

```
ngcp-location-sync
```

- Restart kamailio proxy, panel and mediator services to load migrated location data

```
ngcp-service kamailio-proxy restart
ngcp-service ngcp-panel restart
ngcp-service ngcp-mediator restart
```

14.4 Upgrade from previous versions to mr7.5.1

Note

The document describes upgrade from all mr7.4.* and mr6.5.* LTS releases.

14.4.1 Preparing for maintenance mode

Sipwise C5 introduces **Maintenance Mode** with its mr5.4.1 release. The maintenance mode of Sipwise C5 will disable some background services (for instance: *ngcp-mediator*) during the software upgrade. It thus prevents the system from getting into an inconsistent state while the upgrade is being performed. You can activate maintenance mode by applying a simple configuration change as described later.

- Enable maintenance mode:

```
ngcpcfg set /etc/ngcp-config/config.yml "general.maintenance=yes"
```

- Apply configuration changes by executing:

```
ngcpcfg apply 'Enabling maintenance mode before the upgrade to mr7.5.1'
```

14.4.2 Set the proper software repositories



Warning

Ensure you are using the Sipwise APT repositories. Public Debian mirrors may not provide packages for old Debian releases anymore. Also, they might be outdated. Consider using Sipwise repositories for the time of the upgrade.

Execute the following commands as *root*:

```
echo "# Please visit /etc/apt/sources.list.d/ instead." > /etc/apt/sources.list

mkdir -p /etc/apt/sources.list.d
for file in /etc/apt/sources.list.d/*.list ; do mv "${file}" "${file}.DISABLED" ; done

NGCP_CURRENT_VERSION=$(cat /etc/ngcp_version)
cat > /etc/apt/sources.list.d/debian.list << EOF
# Debian repositories, deployed via upgrade ${NGCP_CURRENT_VERSION}->mr7.5.1
deb https://debian.sipwise.com/debian/ stretch main contrib non-free
#deb-src https://debian.sipwise.com/debian/ stretch main contrib non-free
#
deb https://debian.sipwise.com/debian-security/ stretch-security main contrib non-free
#deb-src https://debian.sipwise.com/debian-security/ stretch-security main contrib non-free
#
deb https://debian.sipwise.com/debian/ stretch-updates main contrib non-free
#deb-src https://debian.sipwise.com/debian/ stretch-updates main contrib non-free

deb https://debian.sipwise.com/debian-debug/ stretch-debug main contrib non-free
#deb-src https://debian.sipwise.com/debian-debug/ stretch-debug main contrib non-free
EOF

NGCP_CURRENT_VERSION=$(cat /etc/ngcp_version)
cat > /etc/apt/sources.list.d/sipwise.list << EOF
# NGCP_MANAGED_FILE
# Sipwise repository, deployed via upgrade ${NGCP_CURRENT_VERSION}->mr7.5.1
deb https://deb.sipwise.com/spce/${NGCP_CURRENT_VERSION}/ stretch main
#deb-src https://deb.sipwise.com/spce/${NGCP_CURRENT_VERSION}/ stretch main
EOF
```

**Warning**

Do not use "ngcpcfg apply/build" after executing the steps from the above block, as otherwise the changes will be overwritten and you will have to redo these steps. Run "apt-get update" and ensure you have no warnings/errors here.

14.4.3 Switch to new repositories

To upgrade Sipwise C5 to release mr7.5.1, execute the following commands:

```
NGCP_CURRENT_VERSION=$(cat /etc/ngcp_version)
sed -i "s/${NGCP_CURRENT_VERSION}/mr7.5.1/" /etc/apt/sources.list.d/sipwise.list

sed -i "s/stretch/buster/g" /etc/apt/sources.list.d/sipwise.list /etc/apt/sources.list.d/ ↵
    debian.list

apt-get update
apt-get install ngcp-upgrade-ce
```

14.4.4 Upgrade Sipwise C5

Run the upgrade script as *root* like this:

```
ngcp-upgrade
```

Note

Sipwise C5 can be upgraded to mr7.5.1 from previous release or previous build only. The script `ngcp-upgrade` will find all the possible destination releases for the upgrade and makes it possible to choose the proper one.

Note

If there is an error during the upgrade, the `ngcp-upgrade` script will request you to solve it. Once you've fixed the problem, just execute `ngcp-upgrade` again and it will continue from the previous step.

The upgrade script will ask you to confirm that you want to start. Read the given information **carefully**, and if you agree, proceed with *y*.

The upgrade process will take several minutes, depending on your network connection and server performance. After everything has been updated successfully, it will finally ask you to reboot your system. Confirm to let the system reboot (it will boot with an updated kernel).

Once up again, double-check your config file `/etc/ngcp-config/config.yml` (sections will be rearranged now and will contain more parameters) and your domain/subscriber/peer configuration and test the setup.

14.4.5 `ngcp-upgrade` options

The following options in `ngcp-upgrade` can be specially useful in some instances of upgrade:

- **`--step-by-step`**: confirm before proceeding to next step. With this option the upgrade operation is performed confirming every step before execution, with the possibility to instruct to continue without confirming further steps until the end (if confirmation is only needed for some steps at the beginning).
- **`--pause-before-step STEP_NAME`**: pause execution before step, given by the name of the script (e.g. "backup_mysql_db"). This option can be useful in several scenarios, for example:
 - to help to debug problems or work around known problems during upgrades. In this case the operator can pause at a given step known to be problematic or just before a problematic set, perform some manual checks or changes, then continue the upgrade until another step (with confirmation like with the recent option `--step-by-step`), or just continue without stop until the end
 - another use might be to help to speed up upgrades when it involves several nodes: they can all proceed in parallel when it's known to be safe to do so; then perform some parts in lock-step (some nodes waiting until others finish with some stage); then continue in parallel until the end
- **`--skip-db-backup`**: This will speed-up the process in cases where it's deemed unnecessary, and this is very likely in the upgrade of nodes other than the first.

14.5 Post-upgrade tasks

14.5.1 Disabling maintenance mode

In order to disable the *maintenance mode*, do the following:

- Disable the maintenance mode:

```
ngcpcfg set /etc/ngcp-config/config.yml "general.maintenance=no"
```

- Apply the changes to configuration templates:

```
ngcpcfg apply 'Disable the maintenance mode after the upgrade to mr7.5.1'
```

14.5.2 Post-upgrade checks

When everything has finished successfully, check that replication is running. Check `ngcp-status`. Finally, do a basic functionality test. Check the web interface, register two test subscribers and perform a test call between them to ensure call routing works.

Note

You can find a backup of some important configuration files of your existing installation under `/ngcp-data/backup/ngcp-mr7.5.1-*` (where `*` is a place holder for a timestamp) in case you need to roll back something at any time. A log file of the upgrade procedure is available at `/ngcp-data/backup/ngcp-mr7.5.1-*/upgrade.log`.

14.6 Applying the Latest Hotfixes

If your current release is already the latest or you prefer to be on the LTS release, we still suggest applying the latest hotfixes and critical bug fixes.

Execute all steps as described in Section 14.3. They include the system checks, `customtt/patchtt` preparation and others. It is important to execute all the steps from the above chapter.

14.6.1 Apply hotfixes

```
ngcp-update
```

14.6.2 Recheck or update the custom configuration templates

Merge/add the custom configuration templates if needed.

Apply the changes to configuration templates:

```
ngcpcfg apply 'apply customtt/patchtt after installing the latest packages'
```

Execute the final checks as described in the **Post-upgrade checks** section.

15 Backup, Recovery and Database Maintenance

15.1 Sipwise C5 Backup

For any service provider it is important to maintain a reliable backup policy as it enables prompt services restoration after any force majeure event. Hence, we strongly suggest you to configure a backup procedure. The Sipwise C5 can be integrated with any Debian compatible backup software.

15.1.1 What data to back up

- The database

This is the most important data in the system. All subscriber and billing information, CDRs, user preferences, etc. are stored in the MySQL server. It is strongly recommended to have up-to-date dumps of all the databases.

- System configuration

The system configuration files such as */etc/mysql/sipwise.cnf* and the */etc/ngcp-config/* directory should be included in the backup as well. We suggest backing up the whole */etc* folder.

- Exported CDRs (optional)

The */home/jail/home/cdrexpert* directory contains the exported CDRs. It depends on your call data retention policy whether or not to remove these files after exporting them to an external system.

15.2 Recovery

In the worst case scenario, when the system needs to be recovered from a total loss, you only need 4 steps to get the services back online:

- Install Sipwise C5 as explained in chapter 2.
- Restore the */etc/ngcp-config/* directory and the */etc/mysql/sipwise.cnf* file from the backup, overwriting your local files.
- Restore the database from the latest MySQL dump.
- Apply the changes to bring the original configuration into effect:

```
ngcpcfg apply 'restored the system from the backup'
```

15.3 Reset Database



Important

All existing data will be wiped out! Use this script only if you want to clear all previously configured services and start configuration from scratch.

To reset database to its original state you can use a script provided by CE: * Execute *ngcp-reset-db*. It will assign new unique passwords for Sipwise C5 services and reset all services. The script will also create dumps for all Sipwise C5 databases.

15.4 Accounting Data (CDR) Cleanup

Sipwise Sipwise C5 offers an easy way to cleanup, backup or archive old accounting data—i.e. CDRs—that is not necessary for further processing any more, or must be deleted according to the law. There are some Sipwise C5 components designed for this purpose and they are commonly called *cleantools*. These are basically configurable scripts that interact with NGCP's *accounting* and *kamailio* databases, or remove exported CDR files in order to clean or archive the unnecessary data.

15.4.1 Cleanuptools Configuration

The configuration parameters of *cleantools* are located in the main Sipwise C5 configuration file: `/etc/ngcp-config/config.yml`. Please refer to the `config.yml` file description: [Cleanuptools Configuration Data](#) for configuration parameter details.

In case the system administrator needs to modify some configuration value, the new configuration must be activated in the usual way, by running the following commands:

```
> ngcpcfg apply 'Modified cleantools config'
```

As a result new configuration files will be generated for the accounting database and the exported CDR cleanup tools. Please read detailed description of those tools in subsequent sections of the handbook.

The Sipwise C5 system administrator can also select the time when cleanup scripts are run, by modifying the schedule here: `/etc/cron.d/cleanup-tools`

15.4.2 Accounting Database Cleanup

The script responsible for cleaning up the database is: `ngcp-cleanup-acc`

The configuration file used by the script is: `/etc/ngcp-cleanup-tools/acc-cleanup.conf`

An extract from a sample configuration file is provided here:

```
#####

batch = 10000
archive-target = /ngcp-data/backup/cdr
compress = gzip

username = dbcleaner
password = rcKamRdHhx7saYRbkJfP
host = localhost

connect accounting
time-column = from_unixtime(start_time)
backup-months = 2
backup-retro = 2
backup cdr

connect accounting
archive-months = 2
archive cdr

connect kamailio
time-column = time
cleanup-days = 90
cleanup acc

# Clean up after ngcp-mediator by deleting old leftover acc entries and
# deleting old entries out of acc_trash and acc_backup
connect kamailio
time-column = time
cleanup-days = 30
cleanup acc_trash
cleanup acc_backup
```

The configuration file itself contains a detailed description of how database cleanup script works. It consists of a series of statements, one per line, which are going to be executed in sequence. A statement can either just set a variable to some value, or perform an action.

There are 3 types of actions the database cleanup script can take:

- backup CDRs
- archive CDRs
- cleanup CDRs

These actions are discussed in following sections.

A generic action is connecting to the proper database: `connect <database name>`

15.4.2.1 Backup CDRs

The database cleanup tool can create *monthly backups* of CDRs in the `accounting` database and store those data records in separate tables named: `cdr_YYYYMM`. The instruction in the configuration file looks like: `backup <table name>`, by default and typically it is: `backup cdr`

Configuration values that govern the backup procedure are:

- `time-column`: Which column in `cdr` table shows the month which a CDR belongs to.
- `batch`: How many records to process within a single SQL statement. If unset, less than or equals 0, all of them are processed at once.
- `backup-months`: How many months worth of records to keep in the `cdr` table—where current CDRs are stored—and not move into the monthly backup tables.



Important

Months are always processed as a whole, thus the value specifies how many months to keep AT MOST. In other words, if the script is started on December 15th and this value is set to "2", then all of December and November is kept, and all of October will be backed up.

- `backup-retro`: How many months to process for backups, going backwards in time. Using the example above, with this value set to "3", the months October, September and August would be backed up, while any older records would be left untouched.

15.4.2.2 Archive CDRs

The database cleanup tool can archive (dump) old monthly backup tables. The statement used for this purpose is: `archive <table name>`, by default and typically it is: `archive cdr`

This creates an SQL dump out of too old tables created by the `backup` statement and drop them afterwards from database. Archiving uses the following configuration values:

- `archive-months`: Uses the same logic as the `backup-months` variable above. If set to "12" and the script was started on December 15th, it will start archiving with the December table of the previous year.



Important

Note that the sum of `backup-retro + backup-months` values cannot be larger than `archive-months` value for the same table. Otherwise you end up creating empty monthly backup tables, only to dump and delete them right afterwards.

- `archive-target`: Target directory for writing the SQL dump files into. If explicitly specified as `"/dev/null"`, then no actual archiving will be performed, but instead the tables will only be dropped from database.

- `compress`: If set to "gzip", then gzip the dump files after creation. If unset, do not compress.
- `host`, `username` and `password`: As dumping is performed by an external command, those variables are reused from the `connect` statement.

15.4.2.3 Cleanup CDRs

The database cleanup tool may do database table cleanup without performing backup. In order to do that, the statement: `cleanup <table name>` is used. Typically this has to be done in `kamailio` database, examples:

- `cleanup acc`
- `cleanup acc_trash`
- `cleanup acc_backup`

Basically the `cleanup` statement works just like the `backup` statement, but doesn't actually backup anything, but rather just deletes old records. Configuration values used by the procedure:

- `time-column`: Gives the database column name that shows the time of CDR creation.
- `batch`: The same as with `backup` statement.
- `cleanup-days`: Any record older than this many days will be deleted.

15.4.3 Exported CDR Cleanup

The script responsible for cleaning up exported CDR files is: `ngcp-cleanup-cdr-files`

The configuration file used by exported CDR cleanup script is: `/etc/ngcp-cleanup-tools/cdr-files-cleanup.yml`

A sample configuration file is provided here:

```
enable: no
max_age_days: 30
paths:
-
  path: /home/jail/home/*/20[0-9][0-9][0-9][0-9]/[0-9][0-9]
  wildcard: yes
  remove_empty_directories: yes
  max_age_days: ~
-
  path: /home/jail/home/cdrexpert/resellers/*/20[0-9][0-9][0-9][0-9]/[0-9][0-9]
  wildcard: yes
  remove_empty_directories: yes
  max_age_days: ~
-
```

```
path: /home/jail/home/cdreexport/system/20[0-9][0-9][0-9][0-9]/[0-9][0-9]
wildcard: yes
remove_empty_directories: yes
max_age_days: ~
```

The exported CDR cleanup tool simply deletes CDR files in the directories provided in the configuration file, if those have already expired.

Configuration values that define the files to be deleted:

- `enable`: Enable (`yes`) or disable (`no`) exported CDR cleanup.
- `max_age_days`: Gives the expiration time of the exported CDR files in days. There is a general value which may be overridden by a local value provided at a specific path. The local value is valid for the particular path only.
- `paths`: an array of path definitions
 - `path`: a path where CDR files are to be found and deleted; this may contain wildcard characters
 - `wildcard`: Enable (`yes`) or disable (`no`) using wildcards in the `path`
 - `remove_empty_directories`: Enable (`yes`) or disable (`no`) removing empty directories if those are found in the given `path`
 - `max_age_days`: the local expiration time value for files in the particular `path`

16 Platform Security, Performance and Troubleshooting

Once Sipwise C5 is in production, security and maintenance becomes really important. In this chapter, we'll go through a set of best practices for any production system.

16.1 Sipwise SSH access to Sipwise C5

The Sipwise C5 provides SSH access to the system for Sipwise operational team for debugging and final tuning. Operational team uses user *sipwise* which can be logged in through SSH key only (password access is disabled) from dedicated access server *jump.sipwise.com* only.

To completely remove Sipwise access to your system, please execute as user root:

```
root@myserver:~# ngcp-support-access --disable && apt-get install ngcp-support-noaccess
```

Note

you have to execute the command above on each node of your Sipwise C5 system!



Warning

please ensure that the script complete successfully:

```
* Support access successfully disabled.
```

If you need to restore Sipwise access to the system, please execute as user root:

```
root@myserver:~# apt-get install ngcp-support-access && ngcp-support-access --enable
```



Warning

please ensure that the script complete successfully:

```
* Support access successfully enabled.
```

16.2 Firewalling

16.2.1 Firewall framework

The Sipwise C5 runs a wide range of services. In order to secure the platform while allowing access to Sipwise C5, Sipwise C5 configuration framework provides a set of predefined network zones. Services are aggregated into appropriate zones by default. Zones are assigned to network interfaces (and VLANs if applicable) in `/etc/ngcp-config/network.yml`.

Caution



Though the default firewall setup provided by Sipwise C5 configuration framework provides a safe setup for Sipwise C5, security audits of the platform performed by qualified engineers before commissioning the platform into service are strongly recommended. Customization of the setup requires in-depth knowledge of firewalling principles in general and the *netfilter* facility in particular.

Table 15: Sipwise C5 network zones

Zone name	Description
ha_int	Internal cluster interface providing internal cluster communications between cluster pairs (heartbeat) and synchronization of data and configuration
mon_ext	Interface to connect external monitoring appliances (SNMP)
rtp_ext	Interface for external RTP media relay between Sipwise C5 and endpoints (e.g. user agents, peers)
sip_ext	Interface for external SIP signalling between Sipwise C5 and endpoints (e.g. user agents, peers)
sip_int	Interface for internal signalling, e.g. between load-balancers, proxies and applications servers
ssh_ext	Interface providing external access to Sipwise C5 command line interface
ssh_int	Interface providing internal access to Sipwise C5 command line interface (necessary for ngcp-installer)
web_ext	Interface providing access to the customers' self-care Web panel
web_int	Interface for access to the administrative Web panel, its REST APIs and internal API communications

Note

Additional custom zones may be configured, but will not be automatically integrated into the firewall configuration.

To facilitate firewall functionality, Sipwise C5 uses the Kernel's *netfilter* facility and *iptables-persistent* as an interface to *netfilter*. *Netfilter* is using *tables* and within that *chains* to store rules in this hierarchy: *table* → *chain* → *rule*. Default firewall setups of Sipwise C5 do not use *netfilter* tables *nat* and *raw*, but only default table *filter*.

Note

Custom *nat* rules for IPv4 and IPv6 may be added in file `/etc/ngcp-config/config.yml` in sections `security→firewall→nat_rules4` and `security→firewall→nat_rules6`.

Each *chain* deploys a *default policy* handling packets which did not trigger and rule in a particular *chain*.

Table 16: Sipwise C5 *netfilter* default policies

Chain	Default policy	Description
INPUT	DROP	Handling all packets directly destined for a Sipwise C5 node (only packets matching a rule are allowed)
FORWARD	DROP	Handling all packets received by a Sipwise C5 node and destined for another, non-local IP destination (no default rules added)
OUTPUT	ACCEPT	Handling all packets originating on a Sipwise C5 node (no default rules added)
rtpengine	N/A	Container for rtpengine rule to allow the rule to persist even when the Kernel module is unloaded (e.g. during upgrades)

The default firewall setup provided by Sipwise C5:

- adds rules to INPUT to secure access to platform and services
- blocks all traffic from and to FORWARD
- allows all OUTPUT traffic

16.2.2 Sipwise C5 firewall configuration

The Sipwise C5 comes with a preconfigured set of firewall rules, which can be enabled and configured in `/etc/ngcp-config/config.yml` in section `security→firewall`. Refer to Section [B.1.29](#) for available configuration options.

Firewall configuration is applied by running `ngcpcfg apply`. However, this will not activate new rules automatically to avoid inadvertent self-lockout. To finally activate new firewall rules run `iptables-apply`. This will prompt for another system logon to verify access remains available. If the prompt is not confirmed, firewall rules will automatically be reverted to the previous state re-enabling access to the command line.

Caution

The Sipwise C5 firewall subsystem by default is disabled in `/etc/ngcp-config/config.yml` key `security.firewall.enable: no`. This is to avoid blocking any traffic inadvertently during installation. After the firewall subsystem has been configured appropriately, it needs to be enabled by setting `security.firewall.enable: yes` in `/etc/ngcp-config/config.yml`.

16.2.3 IPv4 System rules

The following set of rules is added by the system upon activation of the firewall subsystem. Individual system rules are configured in `/etc/ngcp-config/templates/etc/iptables/rules.v4.tt2` and `/etc/ngcp-config/templates/etc/iptables/rules.v6.tt2`

Table 17: Firewall system rules

Zone	Chain	Target	Rule	Description
all	INPUT	rtpengine	<code>-p udp -j rtpengine</code>	Redirects all incoming UDP packets to chain <code>rtpengine</code> (putting RTPENGINE rule into a dedicated chain allows for the rule to persist even when the Kernel module gets unloaded, e.g. during upgrades)
all	rtpengine	RTPENGINE	<code>-p udp -j RTPENGINE --id 0</code>	Feeds all RTP packets to RTPENGINE Kernel module
n/a	INPUT	ACCEPT	<code>-i lo -j ACCEPT</code>	Accept all packets received by local loopback interface
all	INPUT	ACCEPT	<code>-m state --state RELATED,ESTABLISHED -j ACCEPT</code>	Accept all incoming packets tied to <i>related</i> or <i>established</i> connections
all	INPUT (IPv4)	ACCEPT	<code>-p icmp -m icmp --icmp-type 8 -j ACCEPT</code>	Accept all ICMP <i>echo</i> messages
all	INPUT (IPv4)	ACCEPT	<code>-p icmp -m icmp --icmp-type 0 -j ACCEPT</code>	Accept all ICMP <i>echo reply</i> messages
all	INPUT (IPv6)	ACCEPT	<code>-A INPUT -p ipv6-icmp -j ACCEPT</code>	Accept all ICMPv6 messages
all	INPUT	cluster	<code>-j cluster</code>	Divert all incoming packets to the <i>cluster</i> chain
all	cluster	ACCEPT	<code>-s <node_ip> -j ACCEPT</code>	Set of rules white-listing all IP-addresses owned by Sipwise C5 platform for incoming traffic
api_int	INPUT	ACCEPT	<code>-p tcp --dport <ossbss.port> -j ACCEPT</code>	Set of rules for all <i>api_int</i> interfaces accepting all incoming packets for API port defined in <code>/etc/ngcp-config/config.yml</code> with key <code>ossbss.port</code>

Table 17: (continued)

Zone	Chain	Target	Rule	Description
mon_ext	INPUT	ACCEPT	<code>+p udp -s <snmpclient_ip> --dport 161 -j ACCEPT</code>	Set of rules for all <i>mon_ext</i> interfaces based on a list of IPs for all SNMP communities configured in <i>snmpd.communities</i>
rtp_ext	INPUT	ACCEPT/ <i>name</i>	<code>-p udp --dport <rtpproxy.minport>:'<rtpproxy.maxport> -j ACCEPT/<i>name</i></code>	Set of rules for all <i>rtp_ext</i> interfaces accepting all incoming packets for RTP port range defined in <i>/etc/ngcp-config/config.yml</i> with keys <i>rtpproxy.minport</i> and <i>rtpproxy.maxport</i> (see note below for custom options)
sip_ext	INPUT	ACCEPT	<code>-p udp --dport <kamailio.lb.port> -j ACCEPT</code>	Set of rules for all <i>sip_ext</i> interfaces accepting all packets on the loda balancer's SIP signalling port defined in <i>/etc/ngcp-config/config.yml</i> with key <i>kamailio.lb.port</i> (UDP)
sip_ext	INPUT	ACCEPT	<code>-p tcp --dport <kamailio.lb.port> -j ACCEPT</code>	Set of rules for all <i>sip_ext</i> interfaces accepting all packets on the loda balancer's SIP signalling port defined in <i>/etc/ngcp-config/config.yml</i> with key <i>kamailio.lb.port</i> (TCP)
sip_ext	INPUT	ACCEPT	<code>-p tcp --dport <kamailio.lb.tls.port> -j ACCEPT</code>	Set of rules for all <i>sip_ext</i> interfaces accepting all packets on the loda balancer's SIP signalling port defined in <i>/etc/ngcp-config/config.yml</i> with key <i>kamailio.lb.tls.port</i> (TCP/TLS)
sip_ext	INPUT	ACCEPT	<code>-p tcp --dport 5222 -j ACCEPT</code>	Set of rules for all <i>sip_ext</i> interfaces accepting all packets on TCP port 5222 (XMPP client)
sip_ext	INPUT	ACCEPT	<code>-p tcp --dport 5269 -j ACCEPT</code>	Set of rules for all <i>sip_ext</i> interfaces accepting all packets on TCP port 5269 (XMPP server)

Table 17: (continued)

Zone	Chain	Target	Rule	Description
sip_ext	INPUT	ACCEPT	<code>-p tcp --dport <pushd.port> -j ACCEPT</code>	Set of rules for all <i>sip_ext</i> interfaces accepting all packets incoming for the <i>pushd</i> server port configured in <i>/etc/ngcp-config/config.yml</i> with key <i>pushd.port</i>
ssh_ext	INPUT	ACCEPT	<code>-A INPUT -i <ssh_ext_interface> -p tcp -s <sshd.permit_support_from> --dport sshd.port -j ACCEPT</code>	List of rules to accept incoming packets for SSH on all <i>ssh_ext</i> interfaces from hosts configured in <i>/etc/ngcp-config/config.yml</i> with key <i>sshd.permit_support_from</i>
web_ext	INPUT	ACCEPT	<code>-p tcp --dport <www_admin.http_csc.port> -j ACCEPT</code>	List of rules to accept incoming packets for the <i>Customer Self Care</i> interface defined in <i>/etc/ngcp-config/config.yml</i> with key <i>www_admin.http_csc.port</i> on all <i>web_ext</i> interfaces
web_int	INPUT	ACCEPT	<code>-p tcp --dport <www_admin.http_admin.port> -j ACCEPT</code>	List of rules to accept incoming packets for the <i>Admin Panel</i> interface defined in <i>/etc/ngcp-config/config.yml</i> with key <i>www_admin.http_admin.port</i> on all <i>web_int</i> interfaces

Caution

To function correctly, the *rtengine* requires an additional *iptables* rule installed. This rule (with a target of `RTPENGINE`) is automatically installed and removed when the *rtengine* starts and stops, so normally you don't need to worry about it. However, any 3rd party firewall solution can potentially flush out all existing *iptables* rules before installing its own, which would leave the system without the required `RTPENGINE` rule and this would lead to decreased performance. It is imperative that any 3rd party firewall solution either leaves this rule untouched, or installs it back into place after flushing all rules out. The complete parameters to install this rule (which needs to go into the `INPUT` chain of the `filter` table) are: `-p udp -j RTPENGINE --id 0`

Note

Some of the parameters used to populate the firewall rules automatically may contain hostnames instead of IP addresses. Since firewall rules need to be configured based on IP addresses by design, Sipwise C5 configuration framework will lookup such hostnames during *ngcpctlg apply* and expand them to the IP addresses as returned by *gethostbyname*. If DNS resolving changes for such hostnames due to changes to DNS the rules will not update automatically. Another run of *ngcpctlg apply* will be needed to reperform the lookup and update the rules to reflect changes in DNS. If this step is omitted, clients may be locked out of the system.

Note

By default, the rules for the *rtp_ext* zone are created with a target of `ACCEPT`. It is optionally possible to create these rules with another *iptables* chain as target, and instruct the RTP proxy to dynamically manage individual rules for each running call in this chain. If this is enabled, the chain with the name given in the `/etc/ngcp-config/config.yml` key `rtpproxy→firewall_iptables_chain` will be created as empty, leaving the effective target for UDP packets within the RTP port range as the table's default policy (normally `DROP`). The RTP proxy will then dynamically create one `ACCEPT` rule for each open RTP media port in the given chain when a call starts, and delete it when the call is finished. It should be noted that dynamically creating and deleting *iptables* rules can incur a significant performance overhead, especially in scenarios with high call volumes, and it is therefore not recommended to enable this feature in such cases.

16.2.4 Custom rules

The Sipwise C5 configuration framework makes it possible to add custom rules to the firewall setup in `/etc/ngcp-config/config.yml`. The custom rules are added after the system rules. Hence, they apply for packets not matched by the systems rules only.

Example custom rule to whitelist all IPv4 traffic from network interface `eth1.301` effectively making VLAN 301 a trusted network:

```
rules4:
  - '-A INPUT -i eth1.301 -j ACCEPT'
```

Example custom rule to accept incoming traffic from monitoring station `203.0.113.93` for an optionally installed `check_mk` agent:

```
rules4:
  - '-A INPUT -p tcp -s 203.0.113.93 --dport 6556 -j ACCEPT'
```

To add hosts or networks to the SSH whitelist they can be either added to key `sshd.permit_support_from` in `/etc/ngcp-config/config.yml` or a custom rule may be used:

```
rules4:
  - '-A INPUT -s 198.51.100.0/24 --dport 22 - j ACCEPT'
  - '-A INPUT -s 203.0.113.93 --dport 22 -j ACCEPT'
```

Note

In custom rules keys from `/etc/ngcp-config/config.yml` cannot be referenced. Thus, the values need to be manually looked up, hard coded, and kept in sync manually. This is by design of YAML.

16.2.5 Example firewall configuration section

An example for Sipwise C5 firewall configuration in `/etc/ngcp-config/config.yml` enabling both the firewall subsystem and the logging facility may look like:

```
security:
  firewall:
    enable: yes
    logging:
      enable: yes
      file: '/var/log/firewall.log'
      tag: 'NGCPFW'
  policies:
    input: 'DROP'
    forward: 'DROP'
    output: 'ACCEPT'
  rules4:
    - '-A INPUT -i eth0 -j ACCEPT'
```

16.3 Password management

The Sipwise C5 comes with some default passwords the user should change during the deployment of the system. They have been explained in the previous chapters of this handbook.

**Important**

Many Sipwise C5 services use MySQL backend. Users and passwords for these services are created during the installation. These passwords are unique for each installation, and the connections are restricted to localhost. You should not change these users and passwords.

16.3.1 The "root" account

The Sipwise C5's super-user account comes with a preconfigured password. It is imperative that this password is changed by the operator immediately after Sipwise C5 is shipped and before it is connected to any potentially unsecure public or private network using a secure password in compliance with existing password policies of the operator. The "root" password must not be shared outside of the operator's organization including Sipwise engineers. The "root" password must not be shared in any publicly accessible communications including e-mail or ticketing systems.

To change the root password log into the freshly deployed system as "root" using the preconfigured password and execute:

```
root@myserver:~# passwd
```

Then follow the prompts to change the password.

The Vagrant/VirtualBox/VMWare Sipwise C5 images come with more default credentials which should be changed immediately:

- The default password of the system account *root* is *sipwise*. A password must be changed immediately using command *passwd root*.
- SSH authorized_keys for users *root* and *sipwise* should be wiped out using command *rm ~root/.ssh/sipwise_vagrant_key ~sipwise/.ssh/sipwise_vagrant_key* for VirtualBox/VMWare images (skip the step if you use Vagrant).

16.3.2 The "administrator" account

The Sipwise C5 Web-interface comes with a preconfigured "administrator" account deployed with a default password. This account can be considered Sipwise C5 application super-user and has far-reaching access to application specific settings via the Web-interface. It is imperative that the password for this account is changed by the operator immediately after Sipwise C5 is shipped and before it is connected to any potentially unsecure public or private network using a secure password in compliance with existing password policies of the operator. The "administrator" password must not be shared outside of the operator's organization including Sipwise engineers. The "administrator" password must not be shared in any publicly accessible communications including e-mail or ticketing systems.

The password for the "administrator" account can be changed via the Web-interface.

16.3.3 The "cdreexport" account

The login for the system account *cdreexport* is disabled by default. Although this is a jailed account, it has access to sensitive information, namely the Call Detail Records of all calls. SSH keys should be used to login this user, or alternatively a really strong password should be used when setting the password via *passwd cdreexport*.

16.3.4 The MySQL "root" user

The *root* user in MySQL has no default password. A password should be set using the *mysqladmin password* command.

16.3.5 The "ngcpssoap" account

Generate new password for user *ngcpssoap* to access the provisioning interfaces, see the details in Section 10.

16.4 Remote *root* logins via SSH

To mitigate possible system intrusions from the outside, it is commonly held best practise to disable remote *root* (administrator) logins. With remote root logins disabled, it's still possible to log into the system via SSH to a regular, non-privileged user account, and then use *sudo* or *su* to elevate account privileges to *root* administrator level.



Warning

For system setup purposes, the default setting on the Sipwise C5 is to permit remote *root* logins via SSH. It is strongly recommended to change this default setting as soon as possible.

Once you've created a user account for yourself that can be used to gain *root* privileges, remote *root* logins can be disabled via the config switch `sshd→permit_root_login` in `/etc/ngcp-config/config.yml`.

```
sshd:
  permit_root_login: yes
```

Valid options are:

- *yes* - permit remote root logins via SSH. Not recommended.
- *no* - prohibit all remote root logins via SSH.
- *prohibit-password* - permit remote root logins, except when password authentication is used. This is a good setting if you still wish to access the *root* account directly using public-key authentication, but also want to prohibit remote brute-force attacks against the *root* account password.
- *forced-commands-only* - identical to *prohibit-password* but with the additional restriction that only SSH config sections that have a forced command (via `command=` or `ForceCommand`) are permitted to log in. For advanced users.

16.5 *sudo-io*: logging input/output of commands run through *sudo*

It is possible to enable logging for the input and output of commands run through *sudo*, along other meta-information like timing, to be able to reproduce sessions.

The logs are saved in directories with a special structure, the numbers are for a so-called "session" or sequence:

```
$BASE_DIR/$USERNAME/00/00/00
```

For example:

```
/var/log/sudo-io/root/00/00/00
```

and within them, several files for tty input and output, stdin/stdout/stderr, and other ancillary files.

New session use *00/00/01*, *00/00/02* and so on.

This is disabled by default, but can be configured in */etc/ngcp-config/config.yml* with the following options:

```
sudo:
  logging:
    enable: no
    exclude_users: []
    max_sessions: 0
```

Valid options are:

- *enable*: *no* (default) or *yes*; to use the feature or not
- *exclude_users*: list of users whose commands are excluded from logging
- *max_sessions*: 0 by default, which means unlimited. If set to a positive integer, the sequence returns to 0 after reaching it, and starts to overwrite the files in the subdir *00/00/00* instead of increasing indefinitely.

**Warning**

This sudo plugin saves all input and output including passwords typed in shell prompts (even when they are not echoed to the screen), and this is unencrypted, so please consider the security implications.

**Warning**

Even if in some versions the compression of these files is enabled (releases mr9.5 and after), some commands can use huge amounts of data and fill-up the available disk space very quickly, and full disk will cause serious problems (failures in services, or even preventing external access to the system to fix the problems). Please consider setting up monitoring of free space, or mitigating measures like setting a small amount of sessions saved, taking data out the system often for preservation and deleting sessions from previous days, etc.

**Warning**

Additionally, this has a performance impact (both CPU and I/O) on every command run with sudo that triggers logging, negligible for most commands but significant when the input or output is large.

16.6 SSL certificates

The Sipwise C5 provides default, self-signed SSL certificates for SSL connections. These certificates are common for every installation. Before going to production state, the system administrator should provide SSL certificates for the web services. These certificates can either be shared by all web interfaces (*provisioning*, *administrator interface* and *customer self care interface*), or separate ones for each them can be used.

- Generate the certificates. The *customer self care interface* certificate should be signed by a certification authority to avoid browser warnings.
- Upload the certificates to the system
- Set the path to the new certificates in `/etc/ngcp-config/config.yml`:
 - `ossbss→apache→autoprov→sslcertfile` and `ossbss→apache→autoprov→sslcertkeyfile` for the *provisioning interface*.
 - `ossbss→apache→restapi→sslcertfile` and `ossbss→apache→restapi→sslcertkeyfile` for the *REST interface*.
 - `www_admin→http_admin→sslcertfile` and `www_admin→http_admin→sslcertkeyfile` for the *admin interface*.
 - `www_admin→http_csc→sslcertfile` and `www_admin→http_csc→sslcertkeyfile` for the *customer self care interface*.
- Apply the configuration changes with `ngcpcfg apply 'added web ssl certs'`.

The Sipwise C5 also provides the self-signed SSL certificates for SIP over TLS services. The system administrator should replace them with certificates signed by a trusted certificate authority if he is going to enable it for the production usage (`kamailio→lb→tls→enable` (disabled by default)).

- Generate the certificates.
- Upload the certificates to the system
- Set the path to the new certificates in `/etc/ngcp-config/config.yml`:
 - `kamailio→lb→tls→sslcertfile` and `kamailio→lb→tls→sslcertkeyfile`.
- Apply the configuration changes with `ngcpcfg apply 'added kamailio certs'`.

16.7 Securing your Sipwise C5 against SIP attacks

The Sipwise C5 allows you to protect your VoIP system against SIP attacks, in particular **Denial of Service** and **brute-force attacks**. Let's go through each of those attacks and let's see how to configure your system in order to face such situations and react against them.

16.7.1 Denial of Service

As soon as you have packets arriving on your Sipwise C5 server, it will require a bit of time of your CPU. Denial of Service attacks are aimed to break down your system by sending floods of SIP messages in a very short period of time and keep your system busy to handle such huge amount of requests. Sipwise C5 allows you to block such kind of attacks quite easily, by configuring the following section in your `/etc/ngcp-config/config.yml`:

```
security:
  dos_ban_enable: yes
  dos_ban_time: 3600
  dos_reqs_density_per_unit: 50
```

```
dos_sampling_time_unit: 2
dos_whitelisted_ips: []
dos_whitelisted_subnets: []
```

Basically, as soon as Sipwise C5 receives more than 50 messages from the same IP in a time window of 2 seconds, that IP will be blocked for 3600 sec, and you will see in the `kamailio-lb.log` a line saying:

```
Nov 9 00:11:53 sp1 lb[41958]: WARNING: <script>: IP '1.2.3.4' is blocked and banned - R=< ↔
null> ID=304153-3624477113-19168@tedadg.testlab.local
```

The banned IP will be stored in kamailio memory, you can check the list via web interface or via the following command:

```
# ngcp-kamctl lb fifo htable.dump ipban
```

Excluding SIP endpoints from banning

There may be some SIP endpoints that send a huge traffic towards Sipwise C5 from a specific IP address. A typical example is a *SIP Peering Server*.



Caution

Sipwise C5 supports handling such situations by excluding all defined *SIP Peering Servers* from DoS protection mechanism.

The Sipwise C5 platform administrator may also add whitelisted IP addresses manually in `/etc/ngcp-config/config.yml` at `kamailio.lb.security.dos_whitelisted_ips` and `kamailio.lb.security.dos_whitelisted_subnets` parameters.

16.7.2 Bruteforcing SIP credentials

This is a very common attack you can easily detect checking your `/var/log/ngcp/kamailio-proxy.log`. You will see INVITE/REGISTER messages coming in with strange usernames. Attackers is trying to spoof/guess subscriber's credentials, which allow them to call out. The very first protection against these attacks is: **ALWAYS USE STRONG PASSWORD**. Nevertheless Sipwise C5 allow you to detect and block such attacks quite easily, by configuring the following `/etc/ngcp-config/config.yml` section:

```
failed_auth_attempts: 3
failed_auth_ban_enable: yes
failed_auth_ban_time: 3600
```

You may increase the number of failed attempt if you want (in some cases it's better to be safed, some users can be banned accidentally because they are not writing the right password) and adjust the ban time. If a user try to authenticate an INVITE (or

REGISTER) for example and it fails more than 3 times, the "user@domain" (not the IP as for Denial of Service attack) will be blocked for 3600 seconds. In this case you will see in your `/var/log/ngcp/kamailio-lb.log` the following lines:

```
Nov 9 13:31:56 sp1 lb[41952]: WARNING: <script>: Consecutive Authentication Failure for 'sipvicous@mydomain.com' UA='sipvicous-client' IP='1.2.3.4' - R=<null> ID =313793-3624525116-589163@testlab.local
```

Both the banned IPs and banned users are shown in the Admin web interface, you can check them by accessing the **Security Bans** section in the main menu. You can check the banned user as well by retrieving the same info directly from kamailio memory, using the following commands:

```
# ngcp-kamctl lb fifo htable.dump auth
```

16.8 Topology Hiding

16.8.1 Introduction to Topology Hiding on NGCP

The term "topology hiding" in SIP is used to describe the measures taken by typically an SBC (Session Border Controller) to hide detailed information of the internal network at the border of which it is located. Pieces of information such as IP addresses and port numbers used by SIP endpoints and intermediaries within the network are considered sensitive, as these can give some hints to potential attackers about the topology of the network.

In a typical SIP session the mandatory headers may carry that sensitive information, for example: *Contact*, *Via*, *Record-Route*, *To*, *From*, *Call-ID*. An SBC applying topology hiding will mangle the content of those headers.

16.8.2 Topology Masking Mechanism

Concealment of sensitive information using this mechanism is achieved through encoding the original content of selected SIP headers. Then Sipwise C5 will create a new SIP URI using a preselected IP address and the encoded content as URI parameter, finally re-assembling the SIP header.

Examples for encoded SIP headers:

```
Record-Route: <sip:127.0.0.8;line=sr-NvaAlWtecghucEhu6WtAcu...>  
Contact: <sip:127.0.0.8;line=sr-NvaAli-1VeL.kRxLcbN86W...>
```

The *load-balancer* element of Sipwise C5 has an SBC role, from the SIP peers point of view. The *LB* offers topology masking function that can be simply activated through a configuration change. By default the function is disabled.

16.8.2.1 Configuration of Topology Masking

Activating topology masking function is possible through the modification of the following configuration parameters in `/etc/ngcp-conf` file (shown below with default values of parameters):

```
kamailio:
  lb:
    security:
      topoh:
        enable: no
        mask_callid: no
        mask_ip: 127.0.0.8
```

Meaning of the configuration parameters:

- `enable`: if set to `yes`, the topology mask will be activated
- `mask_callid`: if set to `yes`, the SIP Call-ID header will also be encoded
- `mask_ip`: an IP address that will be used to create valid SIP URIs, after encoding the real/original header content.

Tip

Any valid, preferably private network address can be used. The suggestion is however to use an address that is not used by any other SIP endpoint or intermediary element in the network.

16.8.2.2 Considerations for Topology Masking

Although masking sensitive information about a VoIP provider's network is desired, there are some potential side effects caused by topology masking.

The most common example is the consequence that **SIP message size may grow** when applying topology masking. The fact that SIP messages become larger may even prevent Sipwise C5 from communicating successfully with another SIP entity (a peer SBC, for example). This can be expected under following circumstances:

- SIP transport protocol is UDP
- SIP messages have more *Via* and *Record-Route* headers
- IP packets of SIP messages without the topology masking feature already have a size close to the MTU

In such a case the IP packets carrying SIP messages with encoded headers will have a size exceeding the MTU, that will cause loss of data in some networks.

The recommended solution in such a case is to use TCP transport for SIP messages.

16.8.3 Topology Hiding Mechanism

This mechanism achieves topology hiding by stripping the SIP routing headers that show topology details and storing those data in the associative data structure (hash) in the Redis DB so that it can look it up when a reply or in-dialog SIP message comes in. From the signaling perspective it simulates a SBC (Session Border Controller) on the LB.

16.8.3.1 Considerations for Topology Hiding

This mechanism offers some benefits over the older topology masking approach:

- It enables the Sipwise C5 to interconnect with SIP endpoints that are not capable of operating through a SIP proxy.
- The message size is decreased because of stripping the SIP Record-Route, Route and Via header fields.
- It solves the interoperability issues with SIP ALG in some cases.
- It retains also the lightweight nature and the efficient operation.

The module uses the auto-expiration of the Redis keys so it can cause temporary spikes in the memory usage and redis keys count until produced data is cleaned up by redis.

16.8.3.2 Configuration of Topology Hiding

Activation of the topology hiding function is done through the modification of the following configuration parameters in `/etc/ngcp-conf` file (shown below with default values of parameters):

```
topos:
  enable: no
  redis_db: 24
```

In order to activate the function, you should set `enable: 'yes'` in `/etc/ngcp-config/config.yml` and leave the Redis DB number unchanged, then execute `ngcpcfg apply "activated topos"`.

16.9 System Requirements and Performance

The Sipwise C5 is a very flexible system, capable of serving from hundreds to several tens of thousands of subscribers in a single node. The system comes with a default configuration, capable of serving up to 50.000 subscribers in a *normal* environment. But there is no such thing as a *normal* environment. And Sipwise C5 has sometimes to be tuned for special environments, special hardware requirements or just growing traffic.

Note

If you have performance issues with regards to disk I/O please consider enabling the *noatime* mount option for the root filesystem. Sipwise recommends the usage of *noatime*, though remove it if you use software which conflicts with its presence.

In this section some parameters will be explained to allow Sipwise C5 administrator tune the system requirements for optimum performance.

Table 18: Requirement_options

Option	Default value	Requirement impact
cleanupools→binlog_days	15	Heavy impact on the harddisk storage needed for mysql logs. It can help to restore the database from backups or restore broken replication.
database→bufferpoolsize	64MB	For test systems or low RAM systems, lowering this setting is one of the most effective ways of releasing RAM. The administrator can check the innodb buffer hit rate on production systems; a hit rate over 99% is desired to avoid bottlenecks.
kamailio→lb→pkg_mem	16	This setting affects the amount of RAM the system will use. Each kamailio-lb worker will have this amount of RAM reserved. Lowering this setting up to 8 will help to release some memory depending on the number of kamailio-lb workers running. This can be a dangerous setting as the lb process could run out of memory. Use with caution.
kamailio→lb→shm_mem	1/16 * Total System RAM	The installer will set this value to 1/16 of the total system RAM. This setting does not change even if the system RAM does so it's up to the administrator to tune it. It has been calculated that 1024 (1GB) is a good value for 50K subscriber environment. For a test environment, setting the value to 64 should be enough. "Out of memory" messages in the kamailio log can indicate that this value needs to be raised.
kamailio→lb→tcp_children	8	Number of TCP workers kamailio-lb will spawn per listening socket. The value should be fine for a mixed UDP-TCP 50K subscriber system. Lowering this setting can free some RAM as the number of kamailio processes would decrease. For a test system or a pure UDP subscriber system 2 is a good value. 1 or 2 TCP workers are always needed.
kamailio→lb→tls→enable	yes	Enable or not TLS signaling on the system. Setting this value to "no" will prevent kamailio to spawn TLS listening workers and free some RAM.
kamailio→lb→udp_children	8	See <i>kamailio→lb→tcp_children</i> explanation
kamailio→proxy→children	8	See <i>kamailio→lb→tcp_children</i> explanation. In this case the proxy only listens udp so these children should be enough to handle all the traffic. It could be set to 2 for test systems to lower the requirements.
kamailio→proxy→*_expires		Set the default and the max and min registration interval. The lower it is more REGISTER requests will be handled by the lb and the proxy. It can impact in the network traffic, RAM and CPU usage.
kamailio→proxy→natping_interval	30	Interval for the proxy to send a NAT keepalive OPTIONS message to the nated subscriber. If decreased, this setting will increase the number of OPTIONS requests the proxy needs to send and can impact in the network traffic and the number of natping processes the system needs to run. See <i>kamailio→proxy→natping_processes</i> explanation.

Table 18: (continued)

Option	Default value	Requirement impact
<code>kamailio→proxy→natping_processes</code>	7	Kamailio-proxy will spawn this number of processes to send keepalive OPTIONS to the nated subscribers. Each worker can handle about 250 messages/second (depends on the hardware). Depending the number of nated subscribers and the <code>kamailio→proxy→natping_interval</code> parameter the number of workers may need to be adjusted. The number can be calculated like $\text{nated_subscribers}/\text{natping_interval}/\text{pings_per_second_per_process}$. For the default options, assuming 50K nated subscribers in the system the parameter value would be $50.000/30/250 = (6,66)$ 7 workers. 7 is the maximum number of processes kamailio will accept. Raising this value will cause kamailio not to start.
<code>kamailio→proxy→shm_mem</code>	1/16 * Total System RAM	See <code>kamailio→lb→shm_mem</code> explanation.
<code>rateomat→enable</code>	yes	Set this to no if the system shouldn't perform rating on the CDRs. This will save CPU usage.
<code>rsyslog→external_log</code>	0	If enabled, the system will send the log messages to an external server. Depending on the <code>rsyslog→external_loglevel</code> parameter this can increase dramatically the network traffic.
<code>rsyslog→ngcp_logs_preserve_days</code>	93	This setting will set the number of days ngcp logs under <code>/var/log/ngcp</code> will be kept in disk. Lowering this setting will free a high amount of disk space.

Tip

In case of using virtualized environment with limited amount of hardware resources, you can use the script `ngcp-toggle-performance-config` to adjust Sipwise C5 configuration for high/low performance:

```
root@spce:~# /usr/sbin/ngcp-toggle-performance-config
/usr/sbin/ngcp-toggle-performance-config - tool to adjust Sipwise C5 configuration for low ↔
/high performance

--help           Display this usage information
--high-performance Adjust configuration for system with normal/high performance
--low-performance Adjust configuration for system with low performance (e.g. VMs)

root@spce:~#
```

16.10 Troubleshooting

The Sipwise C5 platform provides detailed logging and log files for each component included in the system via rsyslog. The main folder for log files is `/var/log/ngcp/`, it contains a list of self explanatory log files named by component name.

The Sipwise C5 is a high performance system which requires compromise between traceability (maximum amount of debug information being written to hard drive) and productivity (minimum load on IO subsystem). This is the reason why different log levels are configured for the provided components by default.

Most log files are designed for debugging Sipwise C5 by Sipwise operational team while main log files for daily routine usage are:

Log file	Content	Estimated size
<code>/var/log/ngcp/api.log</code>	API logs providing type and content of API requests and responses as well as potential errors	medium
<code>/var/log/ngcp/panel.log</code> <code>/var/log/ngcp/panel-debug.log</code>	Admin Web UI logs when performing operational tasks on the ngcp-panel	medium
<code>/var/log/ngcp/cdr.log</code>	mediation and rating logs, e.g. how many CDRs have been generated and potential errors in case of CDR generation or rating fails for particular accounting data	medium

Log file	Content	Estimated size
/var/log/ngcp/kamailio-proxy.log	Overview of SIP requests and replies between lb, proxy and sems processes. It's the main log file for SIP overview	huge
/var/log/ngcp/kamailio-lb.log	Overview of SIP requests and replies along with network source and destination information flowing through the platform	huge
/var/log/ngcp/sems.log	Overview of SIP requests and replies between lb, proxy and sems processes	small
/var/log/ngcp/rtp.log	rtpengine related log, showing information about RTP communication	small

**Warning**

it is highly NOT recommended to change default log levels as it can cause system IO overloading which will affect call processing.

Note

the exact size of log files depend on system type, system load, system health status and system configuration, so cannot be estimated with high precision. Additionally operational network parameters like ASR and ALOC may impact the log files' size significantly.

16.10.1 Collecting call information from logs

The easiest way to fetch information about a single call among the log files is the search for the SIP CallID (a unique identifier for a SIP dialog). The call ID is used as call marker in almost all the voip related log file, such as `/var/log/ngcp/kamailio-lb.log` , `/var/log/ngcp/kamailio-proxy.log` , `/var/log/ngcp/sems.log` or `/var/log/ngcp/rtp.log`. Example of kamailio-proxy.log line:

```
Nov 19 00:35:56 sp1 proxy[7475]: NOTICE: <script>: New request on proxy - M=REGISTER R=sip: ←
sipwise.local
F=sip:jdoe@sipwise.local T=sip:jdoe@sipwise.local IP=10.10.1.10:5060 (127.0.0.1:5060) ID ←
=364e4676776621034977934e055d19ea@127.0.0.1 UA='SIP-UA 1.2.3.4'
```

The above line shows the SIP information you can find in a general line contained in `/var/log/ngcp/kamailio-*`:

- M=REGISTER : The SIP Method
- R=sip:sipwise.local : The SIP Request URI
- F=sip:jdoe@sipwise.local : The SIP From header
- T=sip:jdoe@sipwise.local : The SIP To header
- IP=10.10.1.10:5060 (127.0.0.1:5060) : The source IP where the message is coming from. Between brackets it is shown the local internal IP where the message come from (in this case Load Balancer)
- ID=364e4676776621034977934e055d19ea@127.0.0.1 : The SIP CallID.
- UAIP=10.10.1.10 : The User Agent source IP
- UA=SIP-UA 1.2.3.4 : The SIP User Agent header

In order to collect the full log related to a single call, it's necessary to "grep" the `/var/log/ngcp/kamailio-proxy.log` using the **ID=** string, for example:

```
# grep "364e4676776621034977934e055d19ea@127.0.0.1" /var/log/ngcp/kamailio-proxy.log
```

16.10.2 Collecting SIP traces

The Sipwise C5 platform provides several tools to collect SIP traces. It can be used Sipwise C5 `ngrep-sip` tool to collect SIP traces, for example to fetch traffic in text format from outbound and among load balancer, proxy and sems :

```
# ngrep-sip b
```

see the manual to know all the options:

```
# man ngrep-sip
```

The *ngrep* debian tool can be used in order to make a SIP trace and save it into a *.pcap* file :

```
# ngrep -s0 -Wbyline -d any -O /tmp/SIP_trace_file_name.pcap port 5062 or port 5060
```

The *sngrep* debian graphic tool as well can be used to visualize SIP trace and save them in a *.pcap* file :

```
# sngrep
```

17 Monitoring and Alerting

17.1 Internal Monitoring

17.1.1 System monitoring via Telegraf

The platform uses the internal *telegraf* service to monitor many aspects of the system, including CPU, memory, swap, disk, filesystem, network, processes, NTP, Nginx, Redis and MySQL.

The gathered information is stored in *InfluxDB*, in the *telegraf* database.

17.1.2 Sipwise C5 specific monitoring via ngcp-witnessd

The platform uses the internal *ngcp-witnessd* service to monitor Sipwise C5 specific metrics or system metrics currently not tracked by *telegraf*, including memory, process count, Heartbeat, MTA, Kamailio, SIP and MySQL.

The gathered information is stored in *InfluxDB*, in the *ngcp* database.

17.1.3 Monitoring data in InfluxDB

The platform uses *InfluxDB* as a time series database, to store most of the metrics collected in the system.

The monitoring data is used by various components of the platform, including *ngcp-collective-check*, *ngcp-snmp-agent* and by the statistics dashboard powered by *Grafana*.

The monitoring data can also be accessed directly by various means; by using the *influx* command-line tool in CLI or TUI modes; by using the *ngcp-influxdb-extract* wrapper which provides two convenience commands to run arbitrary queries or to fetch the last value for a measurement's field; or by using the HTTP API with *curl* (or other HTTP fetchers), or with the *NGCP::InfluxDB::HTTP* perl module.

See https://docs.influxdata.com/influxdb/v1.1/query_language/spec/ for information about InfluxQL, the query language used by *InfluxDB*.

Tip

To get the list of all measurements for a specific database the following query can be used `SHOW MEASUREMENTS`.

Tip

To get the list of fields for a specific measurement the following query can be used `SELECT LAST(*) FROM "measurement"`.

Tip

To get the list of tags for a specific measurement the following query can be used `SHOW TAG KEYS FROM "measurement"`, and for all the current tag values for a tag `SHOW TAG VALUES FROM "measurement" WITH KEY = "tag"`.

See Section [C.2.1](#) for detailed information about the list of data currently stored in the *InfluxDB ngcp* monitoring database.

17.2 Statistics Dashboard

The platform's administration interface (described in Section [6](#)) provides a graphical overview based on *Grafana* of the most important system health indicators, such as memory usage, load averages and disk usage. VoIP statistics, such as the number of concurrent active calls, the number of provisioned and registered subscribers, etc. is also present.

18 MariaDB encryption

18.1 Overview

MariaDB encryption support (officially called as "Data-at-Rest") enables innodb files, tables and binlogs data encryption so that if copied over the data is not usable without the master key. All the data accessed or modified by clients is encrypted/decrypted on the fly and transparent for the users. The feature comes with a price of 3% to 5% MariaDB performance loss (depending on the hardware, and CPU in particular).

18.2 Configuration

There are new options in `constants.yml`

```
mysql:
  encryption:
    enable: yes
    encrypt_binlog: yes
    key: 1;a356c82422a9031f2e472047ad8220eeea257d611849fbdc9f75b49933f75241
    threads: 4
```

NOTE: all changes in the configuration section will cause the MariaDB server to restart when `ngcpcfg` templates are applied.

- `mysql.encryption.enable`: Switch encryption on/off. Values: *yes,no*, Default: *yes*. When enabled, all tables are being encrypted, it takes from a few seconds to several minutes for MariaDB to encrypt all the data (depending on the overall size) and the encryption procedure is performed in the background, while all the data continues to be fully accessible. Also all new tables are created encrypted by default and it is not possible to disable encryption for specific tables as the encryption is *forced*.
- `mysql.encryption.encrypt_binlog`: Encrypt binlogs. Values: *yes,no*, Default: *yes*. While it is preferred to have this option enabled by default, for scenarios where binlog files need to be parsed, this option can be turned off. It is also possible to use `mysqlbinlog` with `--read-from-remote-server` option to read encrypted binlogs.
- `mysql.encryption.key`: Encryption key. The value is randomly generated during the `cfg-schema` upgrade when the option is added into `constants.yml`. The key is located in `/etc/mysql/keyfile` and normally **MUST NOT** be changed. Changing or loosing the key permanently will render all the MariaDB tablespaces data (databases/tables) unusable.
- `mysql.encryption.threads`: Amount of encryption threads. Default: 4 How many MariaDB encryption threads should be running, this value depends on the MariaDB activity and the overall load and can be manually tuned up for better performance.

18.3 What is not encrypted

- `slow-queries` log
- `mysqld.err` log

- general queries log, if enabled

A Basic Call Flows

A.1 General Call Setup

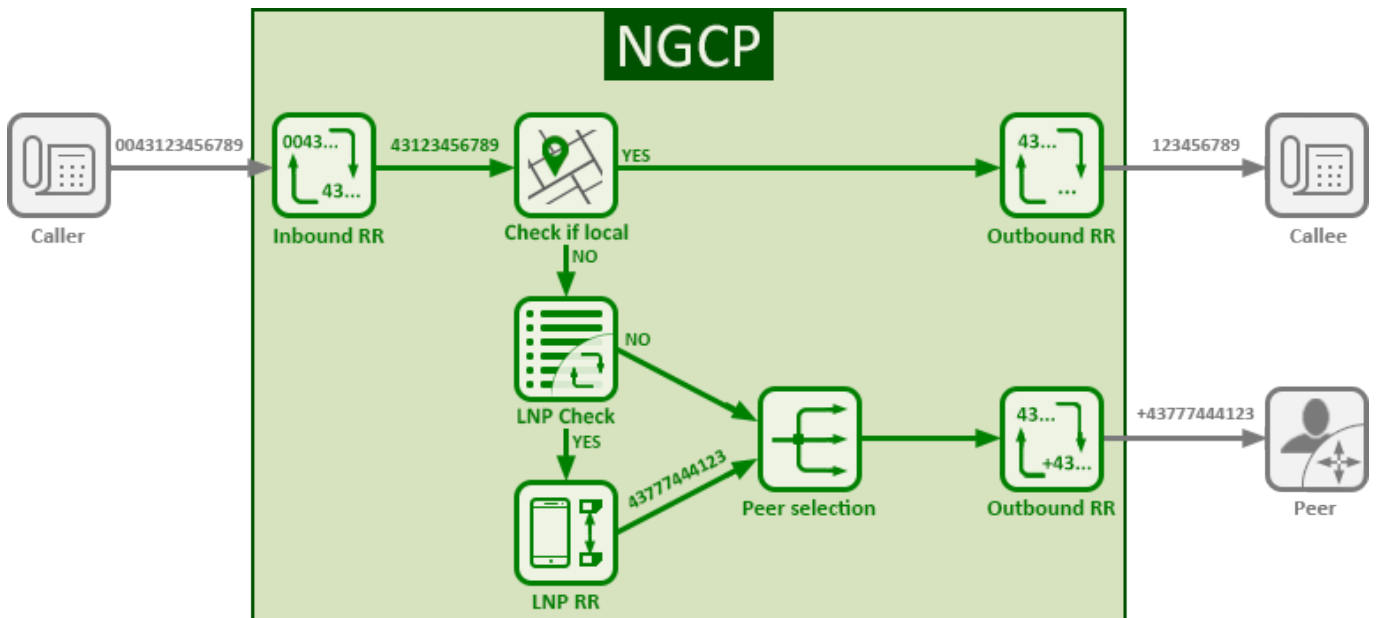

Figure 73: General Call Setup

Sipwise C5 performs the following checks when processing a call coming from a subscriber and terminated at a peer:

- Checks if the IP address where the request came from is in the list of trusted IP addresses. If yes, this IP address is taken as the identity for authentication. Otherwise, Sipwise C5 performs the digest authentication.
- When the subscriber is authorized to make the call, Sipwise C5 applies the Inbound Rewrite Rules for the caller and the callee assigned to the subscriber (if any). If there are no Rewrite Rules assigned to the subscriber, the ones assigned to the subscriber's domain are applied. On this stage the platform normalises the numbers from the subscriber's format to E.164.
- Matches the callee (called number) with local subscribers.
 - If it finds a matching subscriber, the call is routed internally. In this case, Sipwise C5 applies the Outbound Rewrite Rules associated with the callee (if any). If there are no Rewrite Rules assigned to the callee, the ones assigned to the callee's domain are applied.
 - If it does not find a matching subscriber, the call goes to a peer as described below.
- Queries the LNP database to find out if the number was ported or not. For details of LNP queries refer to the [Local Number Porting](#) chapter.
 - If it was ported, Sipwise C5 applies the LNP Rewrite Rules to the called number.
- Based on the priorities of peering groups and peering rules (see Section [6.6.2.3](#) for details), Sipwise C5 selects peering groups for call termination and defines their precedence.

- Within every peering group the weight of a peering server defines its probability to receive the call for termination. Thus, the bigger the weight of a server, the higher the probability that Sipwise C5 will send the call to it.
- Applies the Outbound Rewrite Rules for the caller and the callee assigned to a peering server when sending the call to it.

A.2 Endpoint Registration

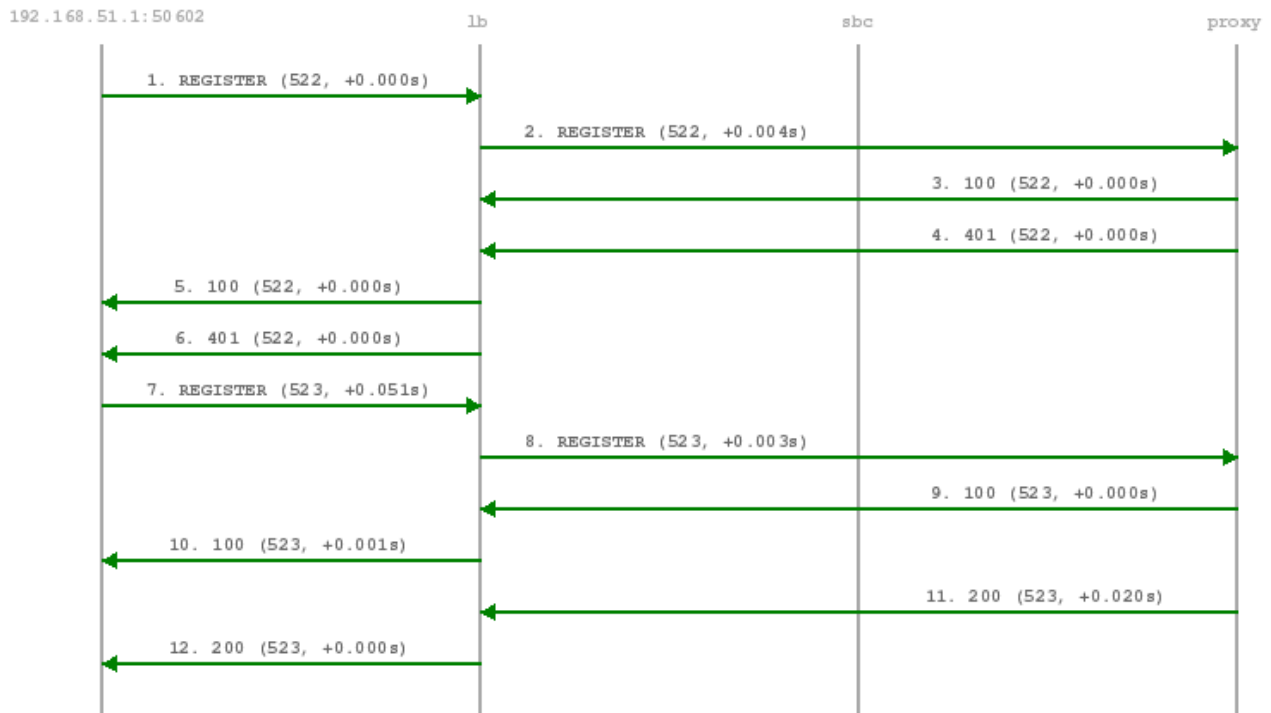

Figure 74: Registration Call-Flow

The subscriber endpoint starts sending a REGISTER request, which gets challenged by a 401. After calculating the response of the authentication challenge, it sends the REGISTER again, including the authentication response. The SIP proxy looks up the credentials of the subscriber in the database, does the same calculation, and if the result matches the one from the subscriber, the registration is granted.

The SIP proxy writes the content of the Contact header (e.g. sip:me@1.2.3.4:1234;transport=UDP) into its location table (in case of NAT the content is changed by the SIP load-balancer to the IP/port from where the request was received), so it knows where to reach a subscriber in case of an inbound call to this subscriber (e.g. sip:someuser@example.org is mapped to sip:me@1.2.3.4:1234;transport=UDP and sent out to this address).

If NAT is detected, the SIP proxy sends a OPTION message to the registered contact every 30 seconds, in order to keep the NAT binding on the NAT device open. Otherwise, for subsequent calls to this contact, Sipwise C5 wouldn't be able to reach the endpoint behind NAT (NAT devices usually drop a UDP binding after not receiving any traffic for ~30-60 seconds).

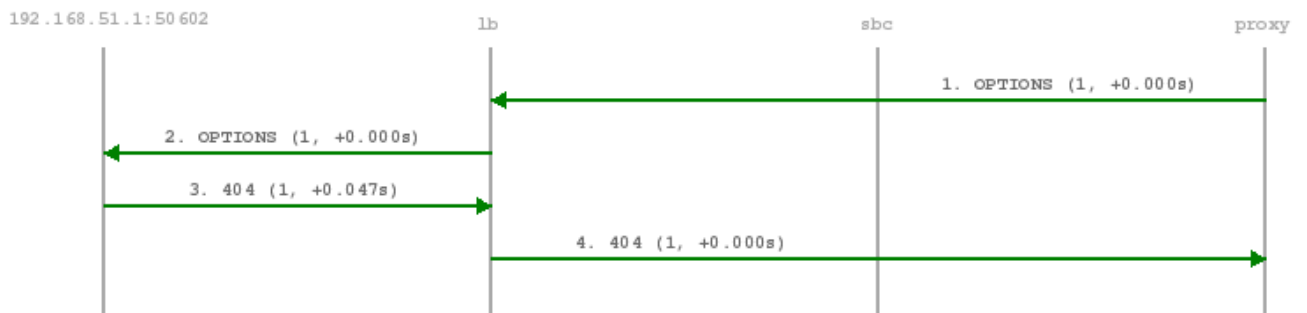

Figure 75: NAT-Ping Call-Flow

By default, a subscriber can register 5 contacts for an Address of Record (AoR, e.g. sip:someuser@example.org).

A.3 Basic Call

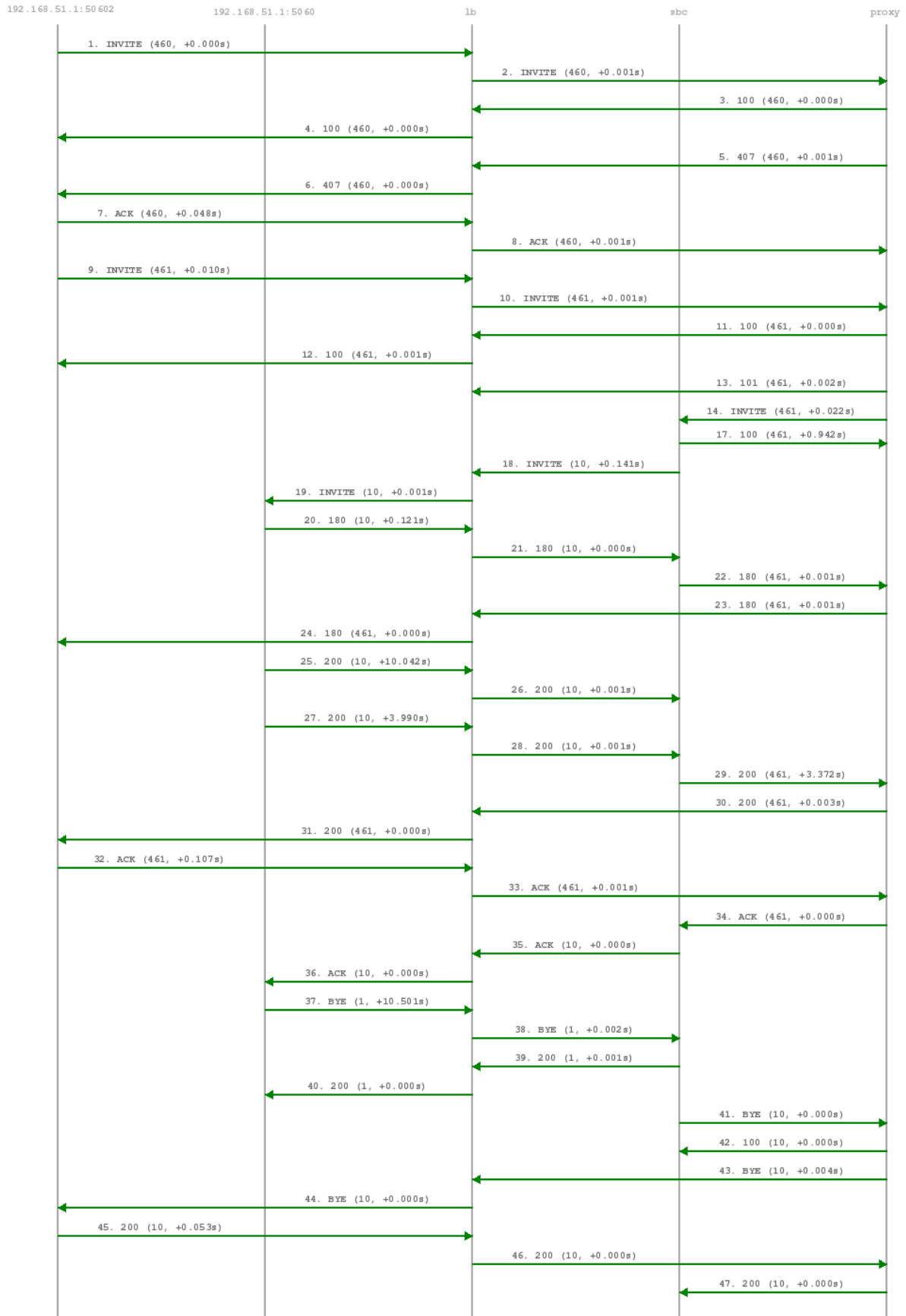

Figure 76: Basic Call Call-Flow

The calling party sends an INVITE (e.g. `sip:someuser@example.org`) via the SIP load-balancer to the SIP proxy. The proxy replies with an authorization challenge in the 407 response, and the calling party sends the INVITE again with authentication credentials. The SIP proxy checks if the called party is a local user. If it is, and if there is a registered contact found for this user, then (after various feature-related tasks for both the caller and the callee) the Request-URI is replaced by the URI of the registered contact (e.g. `sip:me@1.2.3.4:1234;transport=UDP`). If it's not a local user but a numeric user, a proper PSTN gateway is being selected by the SIP proxy, and the Request-URI is rewritten accordingly (e.g. `sip:+43123456789@2.3.4.5:5060`).

Once the proxy has finished working through the call features of both parties involved and has selected the final destination for the call, and - optionally - has invoked the Media Relay for this call, the INVITE is sent to the SIP B2BUA. The B2BUA creates a new INVITE message from scratch (using a new Call-ID and a new From-Tag), copies only various and explicitly allowed SIP headers from the old message to the new one, filters out unwanted media capabilities from the SDP body (e.g. to force audio calls to use G.711 as a codec) and then sends the new message via the SIP load-balancer to the called party.

SIP replies from the called party are passed through the elements back to the calling party (replacing various fields on the B2BUA to match the first call leg again). If a reply with an SDP body is received by the SIP proxy (e.g. a 183 or a 200), the Media Relay is invoked again to prepare the ports for the media stream.

Once the 200 is routed from the called party to the calling party, the media stream is fully negotiated, and the endpoints can start sending traffic to each other (either end-to-end or via the Media Relay). Upon reception of the 200, the SIP proxy writes a start record for the accounting process. The 200 is also acknowledged with an ACK message from the calling party to the called party, according to the SIP 3-way handshake.

Either of the parties can tear down the media session at any time by sending a BYE, which is passed through to the other party. Once the BYE reaches the SIP proxy, it instructs the Media Relay to close the media ports, and it writes a stop record for accounting purposes. Both the start- and the stop-records are picked up by the *ngcp-mediator* service in a regular interval and are converted into a Call Detail Record (CDR), which will be rated by the *ngcp-rate-o-mat* process and can be billed to the calling party.

A.4 Session Keep-Alive

The SIP B2BUA acts as refresher for the Session-Timer mechanism as defined in RFC 4028. If the endpoints indicate support for the UPDATE method during call-setup, then the SIP B2BUA will use an UPDATE message if enabled per peer, domain or subscriber via Provisioning to check if the endpoints are still alive and responsive. Both endpoints can renegotiate the timer within a configurable range. All values can be tuned using the Admin Panel or the APIs using Peer-, Domain- and Subscriber-Preferences.

Tip

Keep in mind that the values being used in the signaling are always half the value being configured. So if you want to send a keep-alive every 300 seconds, you need to provision `sst_expires` to 600.

If one of the endpoints doesn't respond to the keep-alive messages or answers with `481 Call/Transaction Does Not Exist`, then the call is torn down on both sides. This mechanism prevents excessive over-billing of calls if one of the endpoints is not reachable anymore or "forgets" about the call. The BYE message sent by the B2BUA triggers a stop-record for accounting and also closes the media ports on the Media Relay to stop the call.

Beside the Session-Timer mechanism to prevent calls from being lost or kept open, there is a **maximum call length** of 21600 seconds per default defined in the B2BUA. This is a security/anti-fraud mechanism to prevent overly long calls causing excessive costs.

A.5 Voicebox Calls

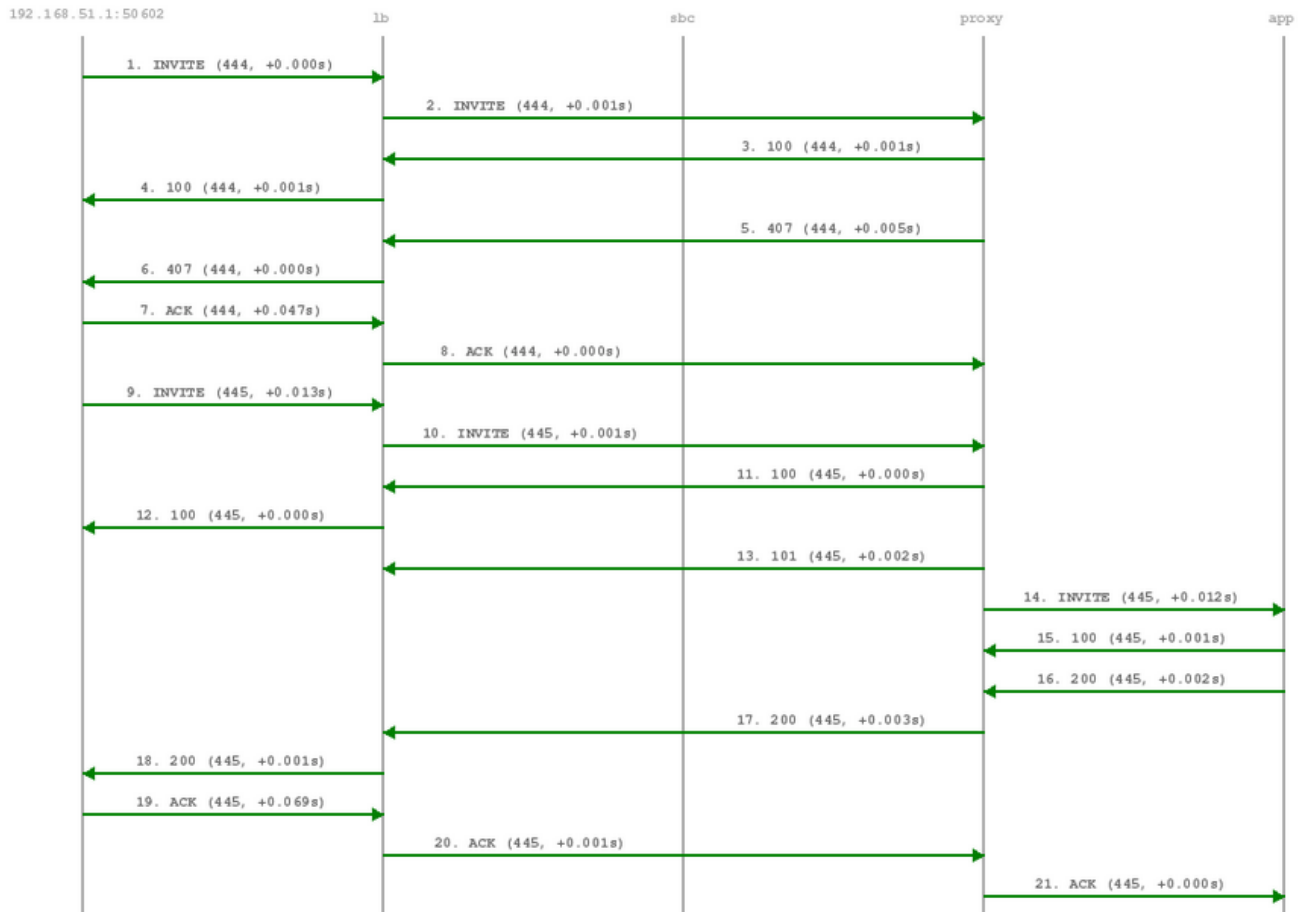

Figure 77: Voicebox Call-Flow

Calls to the Voicebox (both for callers leaving a voicemail message and for voicebox owners managing it via the IVR menu) are passed directly from the SIP proxy to the App-Server without a B2BUA. The App-Server maintains its own timers, so there is no risk of over-billing or overly long calls.

In such a case where an endpoint talks via the Media Relay to a system-internal endpoint, the Media Relay bridges the media streams between the public in the system-internal network.

In case of an endpoint leaving a new message on the voicebox, the Message-Waiting-Indication (MWI) mechanism triggers the sending of a unsolicited NOTIFY message, passing the number of new messages in the body. As soon as the voicebox owner dials into his voicebox (e.g. by calling sip:voicebox@example.org from his SIP account), another NOTIFY message is sent to his devices, resetting the number of new messages.

**Important**

The Sipwise C5 does not require your device to subscribe to the MWI service by sending a SUBSCRIBE (it would rather reject it). On the other hand, the endpoints need to accept unsolicited NOTIFY messages (that is, a NOTIFY without a valid subscription), otherwise the MWI service will not work with these endpoints.

B Sipwise C5 configs overview

B.1 config.yml Overview

`/etc/ngcp-config/config.yml` is the main configuration YAML file used by Sipwise C5. After every changes it need to run the command `ngcpcfg apply "my commit message"` to apply changes (followed by `ngcpcfg push` in the PRO version to apply changes to sp2). The following is a brief description of the main variables contained into `/etc/ngcp-config/config.yml` file.

B.1.1 apps

This section contains parameters for the additional applications that may be activated on Sipwise C5.

```
apps:
  malicious_call: no
```

- `malicious_call`: If set to `yes`, the Malicious Call Identification (MCID) application will be enabled.

B.1.2 asterisk

The following is the asterisk section:

```
asterisk:
  log:
    facility: local6
  rtp:
    maxport: 20000
    minport: 10000
  sip:
    bindport: 5070
    dtmfmode: rfc2833
  voicemail:
    enable: no
    fromstring: 'Voicemail server'
  greeting:
    busy_custom_greeting: '/home/user/file_no_extension'
    busy_overwrite_default: no
    busy_overwrite_subscriber: no
    unavail_custom_greeting: '/home/user/file_no_extension'
    unavail_overwrite_default: no
    unavail_overwrite_subscriber: no
```

```

mailbody: 'You have received a new message from ${VM_CALLERID} in voicebox ${VM_MAILBOX}
        } on ${VM_DATE}.'
mailsubject: '[Voicebox] New message ${VM_MSGNUM} in voicebox ${VM_MAILBOX}'
max_msg_length: 180
maxgreet: 60
maxmsg: 30
maxsilence: 0
min_msg_length: 3
normalize_match: '^00|\|+([1-9][0-9]+)$'
normalize_replace: '$1'
serveremail: voicebox@sip.sipwise.com

```

- `log.facility`: rsyslog facility for asterisk log, defined in `/etc/asterisk/logger.conf`.
- `rtp.maxport`: RTP maximum port used by asterisk.
- `rtp.minport`: RTP minimum port used by asterisk.
- `sip.bindport`: SIP asterisk internal bindport.
- `voicemail.greetings.*`: set the audio file path for voicemail custom unavailable/busy greetings
- `voicemail.mailbody`: Mail body for incoming voicemail.
- `voicemail.mailsubject`: Mail subject for incoming voicemail.
- `voicemail.max_msg_length`: Sets the maximum length of a voicemail message, in seconds.
- `voicemail.maxgreet`: Sets the maximum length of voicemail greetings, in seconds.
- `voicemail.maxmsg`: Sets the maximum number of messages that may be kept in any voicemail folder.
- `voicemail.min_msg_length`: Sets the minimum length of a voicemail message, in seconds.
- `voicemail.maxsilence`: Maxsilence defines how long Asterisk will wait for a contiguous period of silence before terminating an incoming call to voice mail. The default value is 0, which means the silence detector is disabled and the wait time is infinite.
- `voicemail.serveremail`: Provides the email address from which voicemail notifications should be sent.
- `voicemail.normalize_match`: Regular expression to match the From number for calls to voicebox.
- `voicemail.normalize_replace`: Replacement string to return, in order to match an existing voicebox.

B.1.3 autoprov

The following is the autoprovisioning section:

```
autoprov:
  hardphone:
    skip_vendor_redirect: no
  server:
    bootstrap_port: 1445
    ca_certfile: '/etc/ngcp-config/ssl/client-auth-ca.crt'
    host: localhost
    port: 1444
    server_certfile: '/etc/ngcp-config/ssl/myserver.crt'
    server_keyfile: '/etc/ngcp-config/ssl/myserver.key'
    ssl_enabled: yes
  softphone:
    config_lockdown: 0
    webauth: 0
```

- `autoprov.skip_vendor_redirect`: Skip phone vendor redirection to the vendor provisioning web site.

B.1.4 backuptools

The following is the backup tools section:

```
backuptools:
  cdrexport_backup:
    enable: no
  etc_backup:
    enable: no
  mail:
    address: noc@company.org
    error_subject: '[ngcp-backup] Problems detected during daily backup'
    log_subject: '[ngcp-backup] Daily backup report'
    send_errors: no
    send_log: no
  mysql_backup:
    enable: no
    exclude_dbs: 'syslog sipstats information_schema'
  rotate_days: 7
  storage_dir: '/ngcp-data/backup/ngcp_backup'
  temp_backup_dir: '/tmp/ngcp_backup'
```

- `backuptools.cdrexport_backup.enable`: Enable backup of cdrexport (.csv) directory.
- `backuptools.etc_backup.enable`: Enable backup of /etc/* directory.
- `backuptools.mail.address`: Destination email address for backup emails.

- `backuptools.mail.error_subject`: Subject for error emails.
- `backuptools.mail.log_subject`: Subject for daily backup report.
- `backuptools.mail.send_error`: Send daily backup error report.
- `backuptools.mail.send_log`: Send daily backup log report.
- `backuptools.mysql_backup.enable`: Enable daily mysql backup.
- `backuptools.mysql_backup.exclude_dbs`: exclude mysql databases from backup.
- `backuptools.rotate_days`: Number of days backup files should be kept. All files older than specified number of days are deleted from the storage directory.
- `backuptools.storage_dir`: Storage directory of backups.
- `backuptools.storage_group`: Name of the group that backup files should be owned by.
- `backuptools.storage_user`: Name of the user that backup files should be owned by.
- `backuptools.temp_backup_dir`: Temporary storage directory of backups.

B.1.5 cdreexport

The following is the cdr export section:

```
cdreexport:  
  daily_folder: yes  
  export_failed: no  
  export_incoming: no  
  exportpath: '/home/jail/home/cdreexport'  
  full_names: yes  
  monthly_folder: yes
```

- `cdreexport.daily_folder`: Set `yes` if you want to create a daily folder for CDRs under the configured path.
- `cdreexport.export_failed`: Export CDR for failed calls.
- `cdreexport.export_incoming`: Export CDR for incoming calls.
- `cdreexport.exportpath`: The path to store CDRs in `.csv` format.
- `cdreexport.full_names`: Use full names for CDRs instead of short ones.
- `cdreexport.monthly_folder`: Set `yes` if you want to create a monthly folder (ex. 201301 for January 2013) for CDRs under configured path.

B.1.6 cleanuptools

The following is the cleanup tools section:

```
cleanuptools:
  acc_cleanup_days: 90
  archive_targetdir: '/ngcp-data/backups/cdr'
  binlog_days: 15
  cdr_archive_months: 2
  cdr_backup_months: 2
  cdr_backup_retro: 3
  compress: gzip
  delete_old_cdr_files:
    enable: no
    max_age_days: 30
    paths:
      -
        max_age_days: ~
        path: '/home/jail/home/*/20[0-9][0-9][0-9][0-9]/[0-9][0-9]'
        remove_empty_directories: yes
        wildcard: yes
      -
        max_age_days: ~
        path: '/home/jail/home/cdrexpert/resellers/*/20[0-9][0-9][0-9][0-9]/[0-9][0-9]'
        remove_empty_directories: yes
        wildcard: yes
      -
        max_age_days: ~
        path: '/home/jail/home/cdrexpert/system/20[0-9][0-9][0-9][0-9]/[0-9][0-9]'
        remove_empty_directories: yes
        wildcard: yes
  sql_batch: 10000
  trash_cleanup_days: 30
```

- `cleanuptools.acc_cleanup_days`: CDR records in `acc` table in `kamailio` database will be deleted after this time
- `cleanuptools.binlog_days`: Time after MySQL binlogs will be deleted.
- `cleanuptools.cdr_archive_months`: How many months worth of records to keep in monthly CDR backup tables, instead of dumping them into archive files and dropping them from database.
- `cleanuptools.cdr_backup_months`: How many months worth of records to keep in the current `cdr` table, instead of moving them into the monthly CDR backup tables.
- `cleanuptools.cdr_backup_retro`: How many months to process for backups, going backwards in time and skipping `cdr_backup_months` months first, and store them in backup tables. Any older record will be left untouched.

- `cleanuptools.delete_old_cdr_files`:
 - `enable`: Enable (`yes`) or disable (`no`) exported CDR cleanup.
 - `max_age_days`: Gives the expiration time of the exported CDR files in days. There is a general value which may be overridden by a local value provided at a specific path. The local value is valid for the particular path only.
 - `paths`: an array of path definitions
 - * `path`: a path where CDR files are to be found and deleted; this may contain wildcard characters
 - * `wildcard`: Enable (`yes`) or disable (`no`) using wildcards in the `path`
 - * `remove_empty_directories`: Enable (`yes`) or disable (`no`) removing empty directories if those are found in the given `path`
 - * `max_age_days`: the local expiration time value for files in the particular `path`
- `cleanuptools.sql_batch`: How many records to process within a single SQL statement.
- `cleanuptools.trash_cleanup_days`: Time after CDRs from `acc_trash` and `acc_backup` tables in `kamailio` database will be deleted.

For the description of `cleanuptools` please visit [Cleanuptools Description](#) section of the handbook.

B.1.7 cluster_sets

The following is the cluster sets section:

```
cluster_sets:
  default:
    dispatcher_id: 50
    default_set: default
    type: central
```

- `cluster_sets.<label>`: an arbitrary label of the cluster set; in the above example we have `default`
- `cluster_sets.<label>.dispatcher_id`: a unique, numeric value that identifies a particular cluster set
- `cluster_sets.default_set`: selects the default cluster set
- `cluster_sets.type`: the type of cluster set; can be `central` or `distributed`

B.1.8 database

The following is the database section:

```
database:
  bufferpoolsize: 24768M
```

- `database.bufferpoolsize`: `InnoDB_buffer_pool_size` value in `/etc/mysql/my.cnf`

B.1.9 faxserver

The following is the fax server section:

```
faxserver:
  enable: yes
  fail_attempts: '3'
  fail_retry_secs: '60'
  mail_from: 'Sipwise C5 FaxServer <voipfax@ngcp.sipwise.local>'
```

- `faxserver.enable`: *yes/no* to enable or disable `ngcp-faxserver` on the platform respectively.
- `faxserver.fail_attempts`: Amount of attempts to send a fax after which it is marked as *failed*.
- `faxserver.fail_retry_secs`: Amount of seconds to wait between "fail_attempts".
- `faxserver.mail_from`: Sets the e-mail From Header for incoming fax.

B.1.10 general

The following is the general section:

```
general:
  adminmail: adjust@example.org
  companyname: sipwise
  lang: en
  maintenance: no
  production: yes
  timezone: localtime
```

- `general.adminmail`: Email address used by `monit` to send notifications to.
- `general.companyname`: Label used in `SNMPd` configuration.
- `general.lang`: Sets sounds language (e.g. *de* for German)
- `general.production`: Label to hint self-check scripts about installation mode.
- `general.maintenance`: maintenance mode necessary for safe upgrades.
- `general.timezone`: Sipwise C5 Timezone

B.1.11 heartbeat

The following is the heartbeat section:

```
heartbeat:
  hb_watchdog:
    action_max: 5
    enable: yes
    interval: 10
    transition_max: 10
  pingnodes:
    - 10.60.1.1
    - 192.168.3.4
```

- heartbeat.hb_watchdog.enable: Enable heartbeat watchdog in order to prevent and fix split brain scenario.
- heartbeat.hb_watchdog.action_max: Max errors before taking any action.
- heartbeat.hb_watchdog.interval: Interval in secs for the check.
- heartbeat.hb_watchdog.transition_max: Max checks in transition state.
- heartbeat.pingnodes: List of pingnodes for heartbeat. Minimum 2 entries, otherwise by default Sipwise C5 will set the default gateway and DNS servers as pingnodes.

B.1.12 intercept

The following is the legal intercept section:

```
intercept:
  enable: no
```

- intercept.enable: Enable ngcp-voisniff for Lawful Interception (additional Sipwise C5 module).

B.1.13 kamailio

The following is the kamailio section:

```
kamailio:
  lb:
    cfgt: no
  debug:
```

```
enable: no
modules:
- level: '1'
  name: core
- level: '3'
  name: xlog
debug_level: '1'
dns:
  dns_sctp_pref: 1
  dns_tcp_pref: 1
  dns_tls_pref: 1
  dns_try_naptr: no
  dns_udp_pref: 1
  use_dns_cache: on
external_sbc: []
extra_sockets: ~
max_forwards: '70'
mem_log: '1'
mem_summary: '12'
max_inv_lifetime: '180000'
nattest_exception_ips:
- 1.2.3.4
- 5.6.7.8
pkg_mem: '16'
port: '5060'
remove_isup_body_from_replies: no
sdp_line_filter:
  enable: no
  remove_line_startswith: []
security:
  dos_ban_enable: yes
  dos_ban_time: '300'
  dos_reqs_density_per_unit: '50'
  dos_sampling_time_unit: '5'
  dos_whitelisted_ips: []
  dos_whitelisted_subnets: []
  failed_auth_attempts: '3'
  failed_auth_ban_enable: yes
  failed_auth_ban_time: '3600'
topoh:
  enable: no
  mask_callid: no
  mask_ip: 127.0.0.8
topos:
  enable: no
  redis_db: 24
shm_mem: '64'
skip_contact_alias_for_ua_when_tcp:
```

```
    enable: no
    user_agent_patterns: []
start: yes
strict_routing_safe: no
syslog_options: yes
tcp_children: 1
tcp_max_connections: '2048'
tls:
  enable: no
  port: '5061'
  sslcertfile: /etc/ngcp-config/ssl/myserver.crt
  sslcertkeyfile: /etc/ngcp-config/ssl/myserver.key
udp_children: 1
proxy:
  allow_cf_to_itself: no
  allow_info_method: no
  allow_msg_method: no
  allow_peer_relay: no
  allow_refer_method: no
  always_anonymize_from_user: no
  authenticate_bye: no
  block_useragents:
    action: reject
    enable: no
    mode: blacklist
    ua_patterns: []
  cf_depth_limit: '10'
  cfgt: no
  check_prev_forwarder_as_upn: no
  children: 1
  decode_utu_header: no
  debug:
    enable: no
    modules:
      - level: '1'
        name: core
      - level: '3'
        name: xlog
  debug_level: '1'
  default_expires: '3600'
  default_expires_range: '30'
  dlg_timeout: '43200'
  early_rejects:
    block_admin:
      announce_code: '403'
      announce_reason: Blocked by Admin
    block_callee:
      announce_code: '403'
```

```
    announce_reason: Blocked by Callee
block_caller:
    announce_code: '403'
    announce_reason: Blocked by Caller
block_contract:
    announce_code: '403'
    announce_reason: Blocked by Contract
block_in:
    announce_code: '403'
    announce_reason: Block in
block_out:
    announce_code: '403'
    announce_reason: Blocked out
block_override_pin_wrong:
    announce_code: '403'
    announce_reason: Incorrect Override PIN
callee_busy:
    announce_code: '486'
    announce_reason: Busy Here
callee_offline:
    announce_code: '480'
    announce_reason: Offline
callee_tmp_unavailable:
    announce_code: '480'
    announce_reason: Temporarily Unavailable
callee_tmp_unavailable_gp:
    announce_code: '480'
    announce_reason: Unavailable
callee_tmp_unavailable_tm:
    announce_code: '408'
    announce_reason: Request Timeout
callee_unknown:
    announce_code: '404'
    announce_reason: Not Found
cf_loop:
    announce_code: '480'
    announce_reason: Unavailable
emergency_invalid:
    announce_code: '404'
    announce_reason: Emergency code not available in this region
emergency_unsupported:
    announce_code: '403'
    announce_reason: Emergency Calls Not Supported
invalid_speeddial:
    announce_code: '484'
    announce_reason: Speed-Dial slot empty
locked_in:
    announce_code: '403'
```

```
    announce_reason: Callee locked
locked_out:
    announce_code: '403'
    announce_reason: Caller locked
max_calls_in:
    announce_code: '486'
    announce_reason: Busy
max_calls_out:
    announce_code: '403'
    announce_reason: Maximum parallel calls exceeded
no_credit:
    announce_code: '402'
    announce_reason: Insufficient Credit
peering_unavailable:
    announce_code: '503'
    announce_reason: PSTN Termination Currently Unavailable
reject_vsc:
    announce_code: '403'
    announce_reason: VSC Forbidden
relaying_denied:
    announce_code: '403'
    announce_reason: Relaying Denied
unauth_caller_ip:
    announce_code: '403'
    announce_reason: Unauthorized IP detected
emergency_priorization:
    enable: no
    register_fake_200: yes
    register_fake_expires: '3600'
    reject_code: '503'
    reject_reason: Temporary Unavailable
    retry_after: '3600'
enum_suffix: e164.arpa.
expires_range: '30'
filter_100rel_from_supported: no
filter_failover_response: 408|500|503
foreign_domain_via_peer: no
fritzbox:
    enable: no
    prefixes:
    - 0$avp(caller_ac)
    - $avp(caller_cc)$avp(caller_ac)
    - \+$avp(caller_cc)$avp(caller_ac)
    - 00$avp(caller_cc)$avp(caller_ac)
    special_numbers:
    - '112'
    - '110'
    - 118[0-9]{2}
```



```
ignore_auth_realm: no
ignore_subscriber_allowed_clis: no
keep_original_to: no
latency_limit_action: '100'
latency_limit_db: '500'
latency_log_level: '1'
latency_runtime_action: 1000
lnp:
  add_reply_headers:
    enable: no
    number: P-NGCP-LNP-Number
    status: P-NGCP-LNP-Status
  api:
    add_caller_cc_to_lnp_dst: no
    invalid_lnp_routing_codes:
      - ^EE00
      - ^DD00
    keepalive_interval: '3'
    lnp_request_blacklist: []
    lnp_request_whitelist: []
    port: '8991'
    reply_error_on_lnp_failure: no
    request_timeout: '1000'
    server: localhost
    tcap_field_fci: end.components.0.invoke.parameter
    tcap_field_lnp: ConnectArg.destinationRoutingAddress.0
    tcap_field_opcode: end.components.0.invoke.opCode
    enable: no
    execute_ncos_block_out_before_lnp: no
    skip_callee_lnp_lookup_from_any_peer: no
    strictly_check_ncos: no
    type: api
  lookup_peer_destination_domain_for_pbx: no
  loop_detection:
    enable: no
    expire: '1'
    max: '5'
  max_expires: '43200'
  max_gw_lcr: '128'
  max_registrations_per_subscriber: '5'
  mem_log: '1'
  mem_summary: '12'
  min_expires: '60'
  nathelper:
    sipping_from: sip:pinger@sipwise.local
  nathelper_dbro: no
  natping_interval: '30'
  natping_processes: 1
```

```
nonce_expire: '300'
pbx:
  hunt_display_fallback_format: '[H %s]'
  hunt_display_fallback_indicator: $var(cloud_pbx_hg_ext)
  hunt_display_format: '[H %s]'
  hunt_display_indicator: $var(cloud_pbx_hg_displayname)
  hunt_display_maxlength: 8
  ignore_cf_when_hunting: no
  skip_busy_hg_members:
    enable: no
    redis_key_name: totaluser
peer_probe:
  available_treshold: '1'
  enable: yes
  from_uri_domain: probe.ngcp.local
  from_uri_user: ping
  interval: '10'
  method: OPTIONS
  reply_codes: class=2;class=3;code=403;code=404;code=405
  timeout: '5'
  unavailable_treshold: '1'
perform_peer_failover_on_tm_timeout: yes
perform_peer_lcr: no
pkg_mem: '32'
port: '5062'
presence:
  enable: yes
  max_expires: '3600'
  reginfo_domain: example.org
proxy_lookup: no
push:
  apns_alert: New call
  apns_sound: incoming_call.xaf
report_mos: yes
set_ruri_to_peer_auth_realm: no
shm_mem: '125'
start: yes
store_recentcalls: no
syslog_options: yes
tcp_children: 1
tm:
  fr_inv_timer: '180000'
  fr_timer: '9000'
  max_inv_lifetime: '180000'
treat_600_as_busy: yes
use_enum: no
usrloc_dbmode: '1'
voicebox_first_caller_cli: yes
```

```
xfer_other_party_from: no
```

- `kamailio.lb.cfgt`: Enable/disable unit test config file execution tracing.
- `kamailio.lb.debug.enable`: Enable per-module debug options.
- `kamailio.lb.debug.modules`: List of modules to be traced with respective debug level.
- `kamailio.lb.debug_level`: Default debug level for `kamailio-lb`.
- `kamailio.lb.dns.use_dns_cache`: Enable/disable use of internal DNS cache.
- `kamailio.lb.dns.dns_udp_pref`: Set preference for each protocol when doing NAPTR lookups. In order to use remote site preferences set all `dns_*_pref` to the same positive value (e.g. `dns_udp_pref=1`, `dns_tcp_pref=1`, `dns_tls_pref=1`, `dns_sctp_pref=1`). To completely ignore NAPTR records for a specific protocol, set the corresponding protocol preference to `-1`.
- `kamailio.lb.dns.dns_tcp_pref`: See above.
- `kamailio.lb.dns.dns_tls_pref`: See above.
- `kamailio.lb.dns.dns_sctp_pref`: See above.
- `kamailio.lb.dns.dns_try_naptr`: Enable NAPTR support according to RFC 3263.
- `kamailio.lb.external_sbc`: SIP URI of external SBC used in the Via Route option of peering server.
- `kamailio.lb.extra_sockets`: Add here extra sockets for Load Balancer.
- `kamailio.lb.max_forwards`: Set the value for the Max Forwards SIP header for outgoing messages.
- `kamailio.lb.mem_log`: Specifies on which log level the memory statistics will be logged.
- `kamailio.lb.mem_summary`: Parameter to control printing of memory debugging information on exit or SIGUSR1 to log.
- `kamailio.lb.max_inv_lifetime`: Set INVITE transaction timeout per the whole transaction if no final reply for an INVITE arrives after a provisional message was received (whole transaction ringing timeout). It has to be equals or greater than `kamailio.proxy.tm.fr_inv_timer`.
- `kamailio.lb.nattest_exception_ips`: List of IPs that don't need the NAT test.
- `kamailio.lb.shm_mem`: Shared memory used by Kamailio Load Balancer.
- `kamailio.lb.pkg_mem`: PKG memory used by Kamailio Load Balancer.
- `kamailio.lb.port`: Default listen port.
- `kamailio.lb.remove_isup_body_from_replies`: Enable/disable stripping of ISUP part from the message body.
- `kamailio.lb.sdp_line_filter.enable`: Enable/Disable filter of SDP lines in all the SIP messages.
- `kamailio.lb.sdp_line_filter.remove_line_startswith`: List of the SDP lines that should be removed. Attention: it removes all SDP attribute lines beginning with the listed strings in all media streams.
- `kamailio.lb.security.dos_ban_enable`: Enable/Disable DoS Ban.

- `kamailio.lb.security.dos_ban_time`: Sets the ban time.
- `kamailio.lb.security.dos_reqs_density_per_unit`: Sets the requests density per unit (if we receive more than `* lb.dos_reqs_density_per_unit` within `dos_sampling_time_unit` the user will be banned).
- `kamailio.lb.security.dos_sampling_time_unit`: Sets the DoS unit time.
- `kamailio.lb.security.dos_whitelisted_ips`: Write here the whitelisted IPs.
- `kamailio.lb.security.dos_whitelisted_subnets`: Write here the whitelisted IP subnets.
- `kamailio.lb.security.failed_auth_attempts`: Sets how many authentication attempts allowed before ban.
- `kamailio.lb.security.failed_auth_ban_enable`: Enable/Disable authentication ban.
- `kamailio.lb.security.failed_auth_ban_time`: Sets how long a user/IP has be banned.
- `kamailio.lb.topoh.enable`: Enable topology masking module (see the [Topology Masking Mechanism](#) subchapter for a detailed description).
- `kamailio.lb.topoh.mask_callid`: if set to `yes`, the SIP Call-ID header will also be encoded.
- `kamailio.lb.topoh.mask_ip`: an IP address that will be used to create valid SIP URIs, after encoding the real/original header content.
- `kamailio.lb.topos.enable`: Enable topology hiding module (see the [Topology Hiding Mechanism](#) subchapter for a detailed description).
- `kamailio.lb.topos.redis_db`: A number of internal Redis DB used by the topology hiding module.
- `kamailio.lb.start`: Enable/disable kamailio-lb service.
- `kamailio.lb.strict_routing_safe`: Enable strict routing handle feature.
- `kamailio.lb.syslog_options`: Enable/disable logging of SIP OPTIONS messages to `kamailio-options-lb.log`.
- `kamailio.lb.tcp_children`: Number of TCP worker processes.
- `kamailio.lb.tcp_max_connections`: Maximum number of open TCP connections.
- `kamailio.lb.tls.enable`: Enable TLS socket.
- `kamailio.lb.tls.port`: Set TLS listening port.
- `kamailio.lb.tls.sslcertificate`: Path for the SSL certificate.
- `kamailio.lb.tls.sslcertkeyfile`: Path for the SSL key file.
- `kamailio.lb.udp_children`: Number of UDP worker processes.
- `kamailio.proxy.allow_cf_to_itself`: Specify whether or not a Call Forward to the same subscriber (main number to an alias or viceversa) is allowed. To stop the CF loop a source number or a b-number have to be defined in the CF configuration.
- `kamailio.proxy.allow_info_method`: Allow INFO method.
- `kamailio.proxy.allow_msg_method`: Allow MESSAGE method.

- `kamailio.proxy.allow_peer_relay`: Allow peer relay. Call coming from a peer that doesn't match a local subscriber will try to go out again, matching the peering rules.
- `kamailio.proxy.allow_refer_method`: Allow REFER method. Enable it with caution.
- `kamailio.proxy.always_anonymize_from_user`: Enable anonymization of full From URI (as opposed to just From Display-name part by default), has same effect as enabling the preference `anonymize_from_user` for all peers.
- `kamailio.proxy.authenticate_bye`: Enable BYE authentication.
- `kamailio.proxy.block_useragents.action`: one of [`drop`, `reject`] - Whether to silently drop the request from matching User-Agent or reject with a 403 message.
- `kamailio.proxy.block_useragents.enable`: Enable/disable the User-Agent blocking.
- `kamailio.proxy.block_useragents.mode`: one of [`whitelist`, `blacklist`] - Sets the mode of `ua_patterns` list evaluation (whitelist: block requests coming from all but listed User-Agents, blacklist: block requests from all listed User-Agents).
- `kamailio.proxy.block_useragents.ua_patterns`: List of User-Agent string patterns that trigger the block action.
- `kamailio.proxy.cf_depth_limit`: CF loop detector. How many CF loops are allowed before drop the call.
- `kamailio.proxy.cfmt`: Enable/disable unit test config file execution tracing.
- `kamailio.proxy.check_prev_forwarder_as_upn`: Enable/disable validation of the forwarder's number taken from the `Diversion` or `History-Info` header.
- `kamailio.proxy.children`: Number of UDP worker processes.
- `kamailio.proxy.decode_utu_header`: Default *no*. If set to *yes*, the content of the User-to-User field received in 200Ok is decoded and saved in a dedicated field of the ACC records. The decoding consists in few steps: discard everything after the first occurrence of `;`, remove the initial `04`, hex decode the remaining part.
- `kamailio.proxy.debug.enable`: Enable per-module debug options.
- `kamailio.proxy.debug.modules`: List of modules to be traced with respective debug level.
- `kamailio.proxy.debug_level`: Default debug level for `kamailio-proxy`.
- `kamailio.proxy.default_expires`: Default expires value in seconds for a new registration (for REGISTER messages that contains neither Expires HFs nor expires contact parameters).
- `kamailio.proxy.default_expires_range`: This parameter specifies that the expiry used for the registration should be randomly chosen within `default_expires_range` seconds of the `default_expires` parameter.
- `kamailio.proxy.dlg_timeout`: Dialog timeout in seconds (by default 43200 sec - 12 hours).
- `kamailio.proxy.early_rejects`: Customize here the response codes and sound prompts for various reject scenarios. See the subchapter [Configuring Early Reject Sound Sets](#) for a detailed description.
- `kamailio.proxy.emergency_prioritization.enable`: Enable an emergency mode support.
- `kamailio.proxy.emergency_prioritization.register_fake_200`: When enabled, generates a fake 200 response to REGISTER from non-prioritized subscriber in emergency mode.

- `kamailio.proxy.emergency_prioritization.register_fake_expires`: Expires value for the fake 200 response to REGISTER.
- `kamailio.proxy.emergency_prioritization.reject_code`: Reject code for the non-emergency request.
- `kamailio.proxy.emergency_prioritization.reject_reason`: Reject reason for the non-emergency request.
- `kamailio.proxy.emergency_prioritization.retry_after`: Retry-After value when rejecting the non-emergency request.

Tip

In order to learn about details of *emergency prioritization* function of NGCP please refer to Section 7.7 part of the handbook.

- `kamailio.proxy.enum_suffix`: Sets ENUM suffix - don't forget . (dot).
- `kamailio.proxy.expires_range`: Set randomization of expires for REGISTER messages (similar to `default_expires_range` but applies to received expires value).
- `kamailio.proxy.filter_100rel_from_supported`: Enable filtering of *100rel* from Supported header, to disable PRACK.
- `kamailio.proxy.filter_failover_response`: Specify the list of SIP responses that trigger a failover on the next available peering server.
- `kamailio.proxy.foreign_domain_via_peer`: Enable/disable of routing of calls to foreign SIP URI via peering servers.
- `kamailio.proxy.fritzbox.enable`: Enable detection for Fritzbox special numbers. Ex. Fritzbox add some prefix to emergency numbers.
- `kamailio.proxy.fritzbox.prefixes`: Fritybox prefixes to check. Ex. `0$avp(caller_ac)`
- `kamailio.proxy.fritzbox.special_numbers`: Specifies Fritzbox special number patterns. They will be checked with the prefixes defined. Ex. `112`, so the performed check will be `sip:0$avp(caller_ac)112@` if prefix is `0$avp(caller_ac)`
- `kamailio.proxy.ignore_auth_realm`: Ignore SIP authentication realm.
- `kamailio.proxy.ignore_subscriber_allowed_clis`: Set to *yes* to ignore the subscriber's `allowed_clis` preference so that the User-Provided CLI is only checked against customer's `allowed_clis` preference.
- `kamailio.proxy.latency_limit_action`: Limit of runtime in ms for config actions. If a config action executed by `cfg` interpreter takes longer than this value, a message is printed in the logs.
- `kamailio.proxy.latency_limit_db`: Limit of runtime in ms for DB queries. If a DB operation takes longer than this value, a warning is printed in the logs.
- `kamailio.proxy.latency_log_level`: Log level to print the messages related to latency. Default is 1 (INFO).
- `kamailio.proxy.latency_runtime_action`: Limit of runtime in ms for SIP message processing cycle. If the SIP message processing takes longer than this value, a warning is printed in the logs.
- `kamailio.proxy.keep_original_to`: Not used now.
- `kamailio.proxy.lnp.add_reply_headers.enable`: Enable/disable dedicated headers to be added after LNP lookup.
- `kamailio.proxy.lnp.add_reply_headers.number`: Name of the header that will contain the LNP number.

- `kamailio.proxy.lnp.add_reply_headers.status`: Name of the header that will contain the LNP return code (200 if OK, 500/480/... if an error/timeout is occurred).
- `kamailio.proxy.lnp.api.add_caller_cc_to_lnp_dst`: Enable/disable adding of caller country code to LNP routing number of the result (*no* by default, LNP result in E.164 format is assumed).
- `kamailio.proxy.lnp.api.invalid_lnp_routing_codes` [only for `api` type]: number matching pattern for routing numbers that represent invalid call destinations; an announcement is played in that case and the call is dropped.
- `kamailio.proxy.lnp.api.keepalive_interval`: Not used now.
- `kamailio.proxy.lnp.api.lnp_request_whitelist` [only for `api` type]: list of matching patterns of called numbers for which LNP lookup must be done.
- `kamailio.proxy.lnp.api.lnp_request_blacklist` [only for `api` type]: list of matching patterns of called numbers for which LNP lookup must not be done.
- `kamailio.proxy.lnp.api.port`: Not used now.
- `kamailio.proxy.lnp.api.reply_error_on_lnp_failure`: Specifies whether platform should drop the call in case of LNP API server failure or continue routing the call to the original callee without LNP.
- `kamailio.proxy.lnp.api.request_timeout` [only for `api` type]: timeout in milliseconds while Proxy waits for the response of an LNP query from *Sipwise LNP daemon*.
- `kamailio.proxy.lnp.api.server`: Not used now.
- `kamailio.proxy.lnp.api.tcap_field_fci`: path of the FCI INFO in the received tcap message
- `kamailio.proxy.lnp.api.tcap_field_lnp`: path of the LNP NUMBER in the received tcap/inap message
- `kamailio.proxy.lnp.api.tcap_field_opcode`: path of the FCI OPCODE in the received tcap message
- `kamailio.proxy.lnp.enable`: Enable/disable LNP (local number portability) lookup during call setup.
- `kamailio.proxy.lnp.execute_ncos_block_out_before_lnp`: if set to *yes*, the NCOS and BLOCK_OUT checks will be executed before the LNP lookup. Default is *no*, therefore the check are done after the LNP evaluation and rewriting.
- `kamailio.proxy.lnp.skip_callee_lnp_lookup_from_any_peer`: if set to *yes*, the destination LNP lookup is skipped (has same effect as enabling preference `skip_callee_lnp_lookup_from_any_peer` for all peers).
- `kamailio.proxy.lnp.strictly_check_ncos`: specify whether the NCOS LNP should be evaluated even if the LNP lookup was not previously executed or if it didn't return any occurrence. If set to *yes*, a whitelist NCOS will fail if the LNP lookup doesn't return any match. The parameter has no impact on blacklist NCOS.
- `kamailio.proxy.lnp.type`: method of LNP lookup; valid values are: `local` (local LNP database) and `api` (LNP lookup through external gateways). *PLEASE NOTE*: the `api` type of LNP lookup is only available for Sipwise C5 PRO / CARRIER installations.
- `kamailio.proxy.lookup_peer_destination_domain_for_pbx`: one of [*yes*, *no*, `peer_host_name`] - Sets the content of `destination_domain` CDR field for calls between CloudPBX subscribers. In case of *no* this field contains name of CloudPBX domain; *yes*: peer destination domain; `peer_host_name`: human-readable name of the peering server.
- `kamailio.proxy.loop_detection.enable`: Enable the SIP loop detection based on the combination of SIP-URI, To and From header URIs.

- `kamailio.proxy.loop_detection.expire`: Sampling interval in seconds for the incoming INVITE requests (by default 1 sec).
- `kamailio.proxy.loop_detection.max`: Maximum allowed number of SIP requests with the same SIP-URI, To and From header URIs within sampling interval. Requests in excess of this limit will be rejected with 482 Loop Detected response.
- `kamailio.proxy.max_expires`: Sets the maximum expires in seconds for registration.
- `kamailio.proxy.max_gw_lcr`: Defines the maximum number of gateways in `lcr_gw` table
- `kamailio.proxy.max_registrations_per_subscriber`: Sets the maximum registration per subscribers.
- `kamailio.proxy.mem_log`: Specifies on which log level the memory statistics will be logged.
- `kamailio.proxy.mem_summary`: Parameter to control printing of memory debugging information on exit or SIGUSR1 to log.
- `kamailio.proxy.min_expires`: Sets the minimum expires in seconds for registration.
- `kamailio.proxy.nathelper.sipping_from`: Set the From header in OPTIONS NAT ping.
- `kamailio.proxy.nathelper_dbro`: Default is "no". This will be "yes" on CARRIER in order to activate the use of a read-only connection using LOCAL_URL
- `kamailio.proxy.natping_interval`: Sets the NAT ping interval in seconds.
- `kamailio.proxy.natping_processes`: Set the number of NAT ping worker processes.
- `kamailio.proxy.nonce_expire`: Nonce expire time in seconds.
- `kamailio.proxy.pbx.hunt_display_fallback_format`: Default is `[H %s]`. Sets the format of the hunt group indicator that is sent as initial part of the From Display Name when subscriber is called as a member of PBX hunt group if the preferred format defined by the `hunt_display_format` and `hunt_display_indicator` can not be used (as in the case of not provisioned subscriber settings). The `%s` part is replaced with the value of the `hunt_display_fallback_indicator` variable.
- `kamailio.proxy.pbx.hunt_display_fallback_indicator`: The internal kamailio variable that sets the number or extension of the hunt group. Default is `$var (cloud_pbx_hg_ext)` which is populated during call routing with the extension of the hunt group.
- `kamailio.proxy.pbx.hunt_display_format`: Default is `[H %s]`. Sets the format of hunt group indicator that is sent as initial part of the From Display Name when subscriber is called as a member of PBX hunt group. This is the preferred (default) indicator format with Display Name, where the `%s` part is replaced with the value of the `hunt_display_indicator` variable.
- `kamailio.proxy.pbx.hunt_display_indicator`: The internal kamailio variable that contains the preferred identifier of the hunt group. Default is `$var (cloud_pbx_hg_displayname)` which is populated during call routing with the provisioned Display Name of the hunt group.
- `kamailio.proxy.pbx.hunt_display_maxlength`: Default is `8`. Sets the maximum length of the variable used as the part of hunt group indicator in Display Name. The characters beyond this limit are truncated in order for hunt group indicator and calling party information to fit on display of most phones.
- `kamailio.proxy.pbx.ignore_cf_when_hunting`: Default is `no`. Whether to disregard all individual call forwards (CFU, CFB, CFT and CFNA) of PBX extensions when they are called via hunt groups. Note that call forwards configured to local services such as Voicebox or Conference are always skipped from group hunting.
- `kamailio.proxy.pbx.skip_busy_hg_members.enable`: Default is `no`. Whether to skip the subscribers that have busy status when routing the calls to huntgroups.

- `kamailio.proxy.pbx.skip_busy_hg_members.redis_key_name`: one of [`totaluser`, `activeuser`] - Sets the internal redis key name that contains the number of active calls for the user.
- `kamailio.proxy.peer_probe.enable`: Enable the peer probing, must be also checked per individual peer in the panel/API.
- `kamailio.proxy.peer_probe.interval`: Peer probe interval in seconds.
- `kamailio.proxy.peer_probe.timeout`: Peer probe response wait timeout in seconds.
- `kamailio.proxy.peer_probe.reply_codes`: Defines the response codes that are considered successful response to the configured probe request, e.g. `class=2;class=3;code=403;code=404;code=405`, with class defining a code range.
- `kamailio.proxy.peer_probe.unavailable_treshold`: Defines after how many failed probes a peer is considered unavailable.
- `kamailio.proxy.peer_probe.available_treshold`: Defines after how many successful probes a peer is considered available.
- `kamailio.proxy.peer_probe.from_uri_user`: From-userpart for the probe requests.
- `kamailio.proxy.peer_probe.from_uri_domain`: From-hostpart for the probe requests.
- `kamailio.proxy.peer_probe.method`: [OPTIONS|INFO] - Request method for probe request.

Tip

You can find more information about peer probing configuration in Section [7.11.2](#) of the handbook.

- `kamailio.proxy.perform_peer_failover_on_tm_timeout`: Specifies the failover behavior when maximum ring timeout (`fr_inv_timer`) has been reached. In case it is set to *yes*: failover to the next peer if any; in case of *no* stop trying other peers.
- `kamailio.proxy.perform_peer_lcr`: Enable/Disable Least Cost Routing based on peering fees.
- `kamailio.proxy.pkg_mem`: PKG memory used by Kamailio Proxy.
- `kamailio.proxy.shm_mem`: Shared memory used by Kamailio Proxy.
- `kamailio.proxy.port`: SIP listening port.
- `kamailio.proxy.presence.enable`: Enable/disable presence feature
- `kamailio.proxy.presence.max_expires`: Sets the maximum expires value for PUBLISH/SUBSCRIBE message. Defines expiration of the presentity record.
- `kamailio.proxy.presence.reginfo_domain`: Set FQDN of Sipwise C5 domain used in callback for mobile push.
- `kamailio.proxy.push.apns_alert`: Set the content of *alert* field towards APNS.
- `kamailio.proxy.push.apns_sound`: Set the content of *sound* field towards APNS.
- `kamailio.proxy.report_mos`: Enable MOS reporting in the log file.
- `kamailio.proxy.set_ruri_to_peer_auth_realm`: Set R-URI using peer auth realm.
- `kamailio.proxy.start`: Enable/disable kamailio-proxy service.
- `kamailio.proxy.store_recentcalls`: Store recent calls to redis (used by Malicious Call Identification application).

- `kamailio.proxy.syslog_options`: Enable/disable logging of SIP OPTIONS messages to `kamailio-options-proxy.log`.
- `kamailio.proxy.tcp_children`: Number of TCP worker processes.
- `kamailio.proxy.tm.fr_inv_timer`: Set INVITE transaction timeout per branch if no final reply for an INVITE arrives after a provisional message was received (branch ringing timeout).
- `kamailio.proxy.tm.fr_timer`: Set INVITE transaction timeout if the destination is not responding with provisional response message.
- `kamailio.proxy.tm.max_inv_lifetime`: Set INVITE transaction timeout per the whole transaction if no final reply for an INVITE arrives after a provisional message was received (whole transaction ringing timeout). It has to be equals or greater than `kamailio.proxy.tm.fr_inv_timer`.
- `kamailio.proxy.treat_600_as_busy`: Enable the 6xx response handling according to RFC3261. When enabled, the 6xx response should stop the serial forking. Also, CFB will be triggered or busy prompt played as in case of 486 Busy response.
- `kamailio.proxy.use_enum`: Enable/Disable ENUM feature.
- `kamailio.proxy.usrloc_dbmode`: Set the mode of database usage for persistent contact storage.
- `kamailio.proxy.voicebox_first_caller_cli`: When enabled the previous forwarder's CLI will be used as caller CLI in case of chained Call Forwards.
- `kamailio.proxy.xfer_other_party_from`: If set to *yes* transferred calls will have the number of the transferred party in the From header. Default is *no*, thus transferred calls have the number of the transferrer party in the From header.

B.1.14 ngcp-mediator

The following is the `ngcp-mediator` section:

```
mediator:  
  interval: 10
```

- `mediator.interval`: Running interval of `ngcp-mediator`.

B.1.15 modules

The following is the `modules` section:

```
modules:  
  - enable: no  
    name: dummy  
    options: numdummies=2
```

- `modules`: list of configs needed for load kernel modules on boot.
- `enable`: Enable/disable loading of the specific module (yes/no)
- `name`: kernel module name
- `options`: kernel module options if needed

B.1.16 monitoring

The following is the check tools section:

```
monitoring:
  interval: 10
  retrospect_interval: 30
  threshold:
    cpu_idle_min: '0.1'
    disk_used_max: '0.9'
    kamailio_lb_shmem_min: '1048576'
    kamailio_proxy_shmem_min: '1048576'
    load_long_max: '2'
    load_medium_max: '2'
    load_short_max: '3'
    mem_used_max: 0.98
    mta_queue_len_max: '15'
    sip_responsiveness_max: '15'
    sslcert_timetoexpiry: '30'
    sslcert_whitelist: []
    swap_free_min: 0.02
```

- `monitoring.interval`: The number of seconds between each data gathering iteration.
- `monitoring.restrospect_interval`: The number of seconds to look into the past, when checking for the last value for a data point.
- `monitoring.threshold.cpu_idle_min`: Sets the minimum value for CPU usage (0.1 means 10%).
- `monitoring.threshold.disk_used_max`: Sets the maximum value for DISK usage (0.9 means 90%).
- `monitoring.threshold.kamailio_lb_shmem_min`: Sets the minimum value for Kamailio lb share memory usage.
- `monitoring.threshold.kamailio_proxy_shmem_min`: Sets the minimum value for Kamailio proxy share memory usage.
- `monitoring.threshold.load_long_max/load_medium_max/load_short_max`: Max values for load (long, short, medium term).
- `monitoring.threshold.mem_used_max`: Sets the maximum value for memory usage (0.7 means 70%).
- `monitoring.threshold.mta_queue_len_max`: Sets the maximum value for the MTA queue length.
- `monitoring.threshold.sip_responsiveness_max`: Sets the maximum SIP responsiveness time timeout for the SIP options.

- `monitoring.threshold.sslcert_timetoexpiry`: Sets the number of days before a SSL certificate expiry starts to warn.
- `monitoring.threshold.sslcert_whitelist`: Sets a list of SSL certificate fingerprints to whitelist from the expiry check.
- `monitoring.threshold.swap_free_min`: Sets the minimum value for free swap (0.5 means 50%).

B.1.17 nginx

The following is the nginx section:

```
nginx:
  status_port: 8081
  xcap_port: 1080
```

- `nginx.status_port`: Status port used by nginx server
- `nginx.xcap_port`: XCAP port used by nginx server

B.1.18 ntp

The following is the ntp server section:

```
ntp:
  servers:
    - 0.debian.pool.ntp.org
    - 1.debian.pool.ntp.org
    - 2.debian.pool.ntp.org
    - 3.debian.pool.ntp.org
```

- `ntp.servers`: Define your NTP server list.

B.1.19 ossbss

The following is the ossbss section:

```
ossbss:
  apache:
    port: 2443
    proxyluport: 1080
  restapi:
    sslcertfile: '/etc/ngcp-panel/api_ssl/api_ca.crt'
```

```
    sslcertkeyfile: '/etc/ngcp-panel/api_ssl/api_ca.key'
serveradmin: support@sipwise.com
servername: "\"myserver\""
ssl_enable: yes
sslcertfile: '/etc/ngcp-config/ssl/myserver.crt'
sslcertkeyfile: '/etc/ngcp-config/ssl/myserver.key'
frontend: no
htpasswd:
-
    pass: '{SHA}w4zj3mxbmynIQ1jsUEjSkN2z2pk='
    user: ngcpsoap
logging:
apache:
    acc:
        facility: daemon
        identity: oss
        level: info
    err:
        facility: local7
        level: info
ossbss:
    facility: local0
    identity: provisioning
    level: DEBUG
web:
    facility: local0
    level: DEBUG
provisioning:
allow_ip_as_domain: 1
allow_numeric_usernames: 0
auto_allow_cli: 1
carrier:
    account_distribution_function: roundrobin
    prov_distribution_function: roundrobin
credit_warnings:
-
    domain: example.com
    recipients:
        - nobody@example.com
    threshold: 1000
faxpw_min_char: 0
log_passwords: 0
no_logline_truncate: 0
pw_min_char: 6
routing:
    ac_regex: '[1-9]\d{0,4}'
    cc_regex: '[1-9]\d{0,3}'
    sn_regex: '[1-9]\d+'
```

```
tmpdir: '/tmp'
```

- `ossbss.frontend`: Enable/disable SOAP interface. Set value to `fcgi` to enable old SOAP interface.
- `ossbss.htpasswd`: Sets the username and SHA hashed password for SOAP access. You can generate the password using the following command: `htpasswd -nbs myuser mypassword`.
- `ossbss.provisioning.allow_ip_as_domain`: Allow or not allow IP address as SIP domain (0 is not allowed).
- `ossbss.provisioning.allow_numeric_usernames`: Allow or not allow numeric SIP username (0 is not allowed).
- `ossbss.provisioning.faxpw_min_char`: Minimum number of characters for fax passwords.
- `ossbss.provisioning.pw_min_char`: Minimum number of characters for sip passwords.
- `ossbss.provisioning.log_password`: Enable logging of passwords.
- `ossbss.provisioning.routing`: Regexp for allowed AC (Area Code), CC (Country Code) and SN (Subscriber Number).

B.1.20 pbx (only with additional cloud PBX module installed)

The following is the PBX section:

```
pbx:  
  bindport: 5085  
  enable: no  
  highport: 55000  
  lowport: 50001  
  media_processor_threads: 10  
  session_processor_threads: 10  
  xmlrpcport: 8095
```

- `pbx.enable`: Enable Cloud PBX module.

B.1.21 prosody

The following is the prosody section:

```
prosody:  
  ctrl_port: 5582  
  log_level: info
```

- `prosody.ctrl_port`: XMPP server control port.
- `prosody.log_level`: Prosody loglevel.

B.1.22 pushd

The following is the pushd section:

```
pushd:
  apns:
    enable: yes
    endpoint: api.push.apple.com
    endpoint_port: 0
    extra_instances:
      - certificate: '/etc/ngcp-config/ssl/PushCallkitCert.pem'
        enable: yes
        key: '/etc/ngcp-config/ssl/PushCallkitKey.pem'
        type: callkit
    http2_jwt:
      ec_key: '/etc/ngcp-config/ssl/AuthKey_ABCDE12345.pem'
      ec_key_id: 'ABCDE12345'
      enable: yes
      issuer: 'VWXYZ67890'
      tls_certificate: ''
      tls_key: ''
      topic: 'com.example.appID'
    legacy:
      certificate: '/etc/ngcp-config/ssl/PushChatCert.pem'
      feedback_endpoint: feedback.push.apple.com
      feedback_interval: '3600'
      key: '/etc/ngcp-config/ssl/PushChatKey.pem'
    socket_timeout: 0
  domains:
    - apns:
      endpoint: api.push.apple.com
      extra_instances:
        - certificate: '/etc/ngcp-config/ssl/PushCallkitCert-example.com.pem'
          enable: no
          key: '/etc/ngcp-config/ssl/PushCallkitKey-example.com.pem'
          type: callkit
      http2_jwt:
        ec_key: '/etc/ngcp-config/ssl/AuthKey_54321EDCBA.pem'
        ec_key_id: '54321EDCBA'
        issuer: '09876ZYXWV'
        tls_certificate: ''
        tls_key: ''
        topic: 'com.example.otherAppID'
      legacy:
        certificate: '/etc/ngcp-config/ssl/PushChatCert-example.com.pem'
        feedback_endpoint: feedback.push.apple.com
```

```

    key: '/etc/ngcp-config/ssl/PushChatKey-example.com.pem'
domain: example.com
enable: yes
gcm:
    key: 'google_api_key_for_example.com_here'
enable: yes
gcm:
    enable: yes
    key: 'google_api_key_here'
priority:
    call: high
    groupchat: normal
    invite: normal
    message: normal
muc:
    exclude: []
    force_persistent: 'true'
    owner_on_join: 'true'
one_device_per_subscriber: no
port: 45060
processes: 4
ssl: yes
sslcertfile: /etc/ngcp-config/ssl/CAsigned.crt
sslcertkeyfile: /etc/ngcp-config/ssl/CAsigned.key
unique_device_ids: no

```

- `pushd.enable`: Enable/Disable the Push Notification feature.
- `pushd.apns.enable`: Enable/Disable Apple push notification.
- `pushd.apns.endpoint`: API endpoint hostname or address. Should be one of `api.push.apple.com` or `api.development.push.apple.com` for the newer HTTP2/JWT based protocol, or one of `gateway.push.apple.com` or `gateway.sandbox.push.apple.com` for the legacy protocol.
- `pushd.apns.endpoint_port`: API endpoint port. Normally 443 or alternatively 2197 for the newer HTTP2/JWT based protocol, or 2195 for the legacy protocol.
- `pushd.apns.legacy`: Contains all options specific to the legacy APNS protocol. Ignored when HTTP2/JWT is in use.
- `pushd.apns.legacy.certificate`: Specify the Apple certificate for push notification https requests from Sipwise C5 to an endpoint.
- `pushd.apns.legacy.key`: Specify the Apple key for push notification https requests from Sipwise C5 to an endpoint.
- `pushd.apns.legacy.feedback_endpoint`: Hostname or address of the APNS feedback service. Normally one of `feedback.push.apple.com` or `feedback.sandbox.push.apple.com`.
- `pushd.apns.legacy.feedback_interval`: How often to poll the feedback service, in seconds.
- `pushd.apns.extra_instances`: If the iOS app supports Callkit push notifications, they can be enabled here and the required separate certificate and key can be specified. Ignored if HTTP2/JWT is enabled.

- `pushd.http2_jwt`: Contains all options specific to the newer HTTP2/JWT based APNS API protocol.
- `pushd.http2_jwt.ec_key`: Name of file that contains the elliptic-curve (EC) cryptographic key provided by Apple, in PEM format.
- `pushd.http2_jwt.ec_key_id`: 10-digit identification string of the EC key in use.
- `pushd.http2_jwt.enable`: Master switch for the HTTP2/JWT based protocol. Disables the legacy protocol when enabled.
- `pushd.http2_jwt.issuer`: Issuer string for the JWT token. Normally the 10-digit team ID string for which the EC key was issued.
- `pushd.http2_jwt.tls_certificate`: Optional client certificate to use for the TLS connection.
- `pushd.http2_jwt.tls_key`: Optional private key for the client certificate to use for the TLS connection.
- `pushd.http2_jwt.topic`: Topic string for the JWT token. Normally the bundle ID for the iOS app.
- `pushd.gcm.enable`: Enable/Disable Google push notification.
- `pushd.gcm.key`: Specify the Google key for push notification https requests from Sipwise C5 to an endpoint.
- `pushd.domains`: Supports a separate set of push configurations (API keys, certificates, etc) for all subscribers of the given domain.
- `pushd.muc.exclude`: list of MUC room jids excluded from sending push notifications.
- `pushd.muc.force_persistent`: Enable/Disable MUC rooms to be persistent. Needed for Sipwise C5 app to work with other clients.
- `pushd.muc.owner_on_join`: Enable/Disable all MUC participants to be owners of the MUC room. Needed for Sipwise C5 app to work with other clients.
- `pushd.ssl`: The security protocol Sipwise C5 uses for https requests from the app in the push notification process.
- `pushd.sslcertfile`: The trusted certificate file purchased from a CA
- `pushd.sslcertkeyfile`: The key file that purchased from a CA
- `pushd.unique_device_ids`: Allows a subscriber to register the app and have the push notification enabled on more than one mobile device.

B.1.23 qos

The QoS section allows configuring the ToS (Type of Service) feature:

```
qos:  
  tos_rtp: 184  
  tos_sip: 184
```

- `qos.tos_rtp`: a ToS value for RTP traffic.
- `qos.tos_sip`: a ToS value for SIP traffic.

Tip

The ToS byte includes both DSCP and ECN bits. So, specify the DSCP value multiplied by four ($46 \times 4 = 184$) and, optionally, add the required ECN value to it (1, 2 or 3).

Set the `rtproxy.control_tos` parameter higher than zero to enable ToS.

B.1.24 ngcp-rate-o-mat

The following is the *ngcp-rate-o-mat* section:

```
rateomat:
  enable: yes
  loopinterval: 10
  splitpeakparts: 0
```

- `rateomat.enable`: Enable/Disable *ngcp-rate-o-mat*
- `rateomat.loopinterval`: How long we shall sleep before looking for unrated CDRs again.
- `rateomat.splitpeakparts`: Whether we should split CDRs on peakttime borders.

B.1.25 redis

The following is the *redis* section:

```
redis:
  database_amount: 16
  port: 6379
  syslog_ident: redis
```

- `redis.database_amout`: Set the number of databases in redis. The default database is DB 0.
- `redis.port`: Accept connections on the specified port, default is 6379
- `redis.syslog_ident`: Specify the syslog identity.

B.1.26 reminder

The following is the *reminder* section:

```
reminder:
  retries: 2
  retry_time: 60
  sip_fromdomain: voicebox.sipwise.local
  sip_fromuser: reminder
  wait_time: 30
  weekdays: '2, 3, 4, 5, 6, 7'
```

- `reminder.retries`: How many times the reminder feature have to try to call you.
- `reminder.retry_time`: Seconds between retries.
- `reminder.wait_time`: Seconds to wait for an answer.

B.1.27 rsyslog

The following is the rsyslog section:

```
rsyslog:
  elasticsearch:
    action:
      resumeretrycount: '-1'
      bulkmode: 'on'
      dynSearchIndex: 'on'
      enable: yes
      queue:
        dequeuebatchsize: 300
        size: 5000
        type: linkedlist
  external_address:
  external_log: 0
  external_loglevel: warning
  external_port: 514
  external_proto: udp
  ngcp_logs_preserve_days: 93
```

- `rsyslog.elasticsearch.enable`: Enable/Disable Elasticsearch web interface
- `rsyslog.external_address`: Set the remote rsyslog server.
- `rsyslog.ngcp_logs_preserve_days`: Specify how many days to preserve old rotated log files in `/var/log/ngcp/old` path.

B.1.28 rtpproxy

The following is the rtp proxy section:

```
rtpproxy:
  allow_userspace_only: yes
  cdr_logging_facility: ''
  control_tos: 0
  delete_delay: 30
  dtls_passive: no
  enable: yes
  final_timeout: 0
  firewall_iptables_chain: ''
  graphite:
    interval: 600
    prefix: rtpengine.
    server: ''
  log_level: '6'
  maxport: '40000'
  minport: '30000'
  num_threads: 0
  prefer_bind_on_internal: no
  recording:
    enable: no
    mp3_bitrate: '48000'
    log_level: '6'
    nfs_host: 192.168.1.1
    nfs_remote_path: /var/recordings
    output_dir: /var/lib/rtpengine-recording
    output_format: wav
    output_mixed: yes
    output_single: yes
    resample: no
    resample_to: '16000'
    spool_dir: /var/spool/rtpengine
  rtcp_logging_facility: ''
  rtp_timeout: '60'
  rtp_timeout_onhold: '3600'
```

- `rtpproxy.allow_userspace_only`: Enable/Disable the user space failover for rtpengine (*yes* means enable). By default rtpengine works in kernel space.
- `rtpproxy.cdr_logging_facility`: If set, rtpengine will produce a CDR-like syslog line after each call finishes. Must be set to a valid syslog facility string (such as *daemon* or *local0*).
- `rtpproxy.control_tos`: If higher than 0, the control messages port uses the configured ToS (Type of Service) bits. See the QoS section below for details.
- `rtpproxy.delete_delay`: After a call finishes, rtpengine will wait this many seconds before cleaning up resources. Useful for possible late branched calls.

- `rtpproxy.dtls_passive`: If enabled, `rtpproxy` will always advertise itself as a passive role in DTLS setup. Useful in WebRTC scenarios if used behind NAT.
- `rtpproxy.final_timeout`: If set, any calls lasting longer than this many seconds will be terminated, no matter the circumstances.
- `rtpproxy.firewall_iptables_chain`: If set, `rtpproxy` will create an iptables rule for each individual media port opened in this chain.
- `rtpproxy.graphite.interval`: Interval in seconds between sending updates to the Graphite server.
- `rtpproxy.graphite.prefix`: Graphite keys will be prefixed with this string. Must include a separator character (such as a trailing dot) if one should be used.
- `rtpproxy.graphite.server`: Graphite server to send periodic statistics updates to. Disabled if set to an empty string. Must be in format `IP:port` or `hostname:port`.
- `rtpproxy.log_level`: Verbosity of log messages. The default `6` logs everything except debug messages. Increase to `7` to log everything, or decrease to make logging more quiet.
- `rtpproxy.maxport`: Maximum port used by `rtpproxy` for RTP traffic.
- `rtpproxy.minport`: Minimum port used by `rtpproxy` for RTP traffic.
- `rtpproxy.num_threads`: Number of worker threads to use. If set to `0`, the number of CPU cores will be used.
- `rtpproxy.recording.enable`: Enable support for call recording.
- `rtpproxy.recording.mp3_bitrate`: If saving audio as MP3, bitrate of the output file.
- `rtpproxy.recording.log_level`: Same as `log_level` above, but for the recording daemon.
- `rtpproxy.recording.nfs_host`: Mount an NFS share from this host for storage.
- `rtpproxy.recording.nfs_remote_path`: Remote path of the NFS share to mount.
- `rtpproxy.recording.output_dir`: Local mount point for the NFS share.
- `rtpproxy.recording.output_format`: Either `wav` for PCM output or `mp3`.
- `rtpproxy.recording.output_mixed`: Create output audio files with all contributing audio streams mixed together.
- `rtpproxy.recording.output_single`: Create separate audio files for each contributing audio stream.
- `rtpproxy.recording.resample`: Resample all audio to a fixed bitrate (*yes or no*).
- `rtpproxy.recording.resample_to`: If resampling is enabled, resample to this sample rate.
- `rtpproxy.recording.spool_dir`: Local directory for temporary metadata file storage.
- `rtpproxy.rtcp_logging_facility`: If set, `rtpproxy` will write the contents of all received RTCP packets to syslog. Must be set to a valid syslog facility string (such as `daemon` or `local0`).
- `rtpproxy.rtp_timeout`: Consider a call dead if no RTP is received for this long (60 seconds).
- `rtpproxy.rtp_timeout_onhold`: Maximum limit in seconds for an onhold (1h).

B.1.29 security

The following is the security section. Usage of the firewall subsection is described in Section [16.2](#):

```
security:
  firewall:
    enable: no
    logging:
      days_kept: '7'
      enable: yes
      file: /var/log/firewall.log
      tag: NGCPFW
  nat_rules4: ~
  nat_rules6: ~
  policies:
    forward: DROP
    input: DROP
    output: ACCEPT
  rules4: ~
  rules6: ~
```

- `security.firewall.enable`: Enable/disable iptables configuration and rule generation for IPv4 and IPv6 (default: `no`)
- `security.firewall.logging.days_kept`: Number of days logfiles are kept on the system before being deleted (log files are rotated daily, default: `7`)
- `security.firewall.logging.enable`: Enables/disables logging of all packets dropped by Sipwise C5 firewall (default: `yes`)
- `security.firewall.logging.file`: File firewall log messages go to (default: `/var/log/firewall.log`)
- `security.firewall.logging.tag`: String prepended to all log messages (internally `DROP` is added to any tag indicating the action triggering the message, default: `NGCPFW`)
- `security.firewall.nat_rules4`: Optional list of IPv4 firewall rules added to table `nat` using iptables-persistent syntax (default: `undef`)
- `security.firewall.nat_rules6`: Optional list of IPv6 firewall rules added to table `nat` using iptables-persistent syntax (default: `undef`)
- `security.firewall.policies.forward`: Default policy for iptables `FORWARD` chain (default: `DROP`)
- `security.firewall.policies.input`: Default policy for iptables `INPUT` chain (default: `DROP`)
- `security.firewall.policies.output`: Default policy for iptables `OUTPUT` chain (default: `ACCEPT`)
- `security.firewall.rules4`: Optional list of IPv4 firewall rules added to table `filter` using iptables-persistent syntax (default: `undef`)
- `security.firewall.rules6`: Optional list of IPv6 firewall rules added to table `filter` using iptables-persistent syntax (default: `undef`)

B.1.30 sems

The following is the SEMS section:

```
sems:
  bindport: 5080
  conference:
    enable: yes
    max_participants: 10
  debug: no
  highport: 50000
  lowport: 40001
  media_processor_threads: 10
  prepaid:
    enable: yes
  sbc:
    calltimer_enable: yes
    calltimer_max: 3600
    outbound_timeout: 6000
  profile:
    - custom_header: []
      name: ngcp
    - custom_header: []
      name: ngcp_cf
  sdp_filter:
    codecs: PCMA,PCMU,telephone-event
    enable: yes
    mode: whitelist
  session_timer:
    enable: yes
    max_timer: 7200
    min_timer: 90
    session_expires: 300
  session_processor_threads: 10
  vsc:
    block_override_code: 80
    cfb_code: 90
    cfna_code: 93
    cft_code: 92
    cfu_code: 72
    clir_code: 31
    directed_pickup_code: 99
    enable: yes
    park_code: 97
    reminder_code: 55
    speedial_code: 50
```

```
unpark_code: 98
voicemail_number: 2000
xmlrpcport: 8090
```

- `sems.conference.enable`: Enable/Disable conference feature.
- `sems.conference.max_participants`: Sets the number of concurrent participant.
- `sems.highport`: Maximum ports used by sems for RTP traffic.
- `sems.debug`: Enable/Disable debug mode.
- `sems.lowport`: Minimum ports used by sems for RTP traffic.
- `sems.prepaid.enable`: Enable/Disable prepaid feature.
- `sems.sbc.calltimer_max`: Set the default maximum call duration (used if otherwise is not defined by preference).
- `sems.sbc.outbound_timeout`: Set INVITE transaction timeout if the destination is not responding with provisional response message.
- `sems.sbc.profile.name`: Profile's name where to add the custom headers in `header_list` config parameter. Supported values: `ngcp` and `ngcp_cf`.
- `sems.sbc.profile.custom_header`: List of the custom headers that has to be whitelisted (default) by sems sbc in the corresponding profile.
- `sems.sbc.session_timer.enable`: If set to "no" all session timer headers are stripped off without considering the session timer related configuration done via the web interface. If set to "yes" the system uses the subscriber/peer configurations values set on the web interface. If set to "transparent" no validation is performed on Session Timer headers, they are ignored by SEMS and therefore negotiated end-to-end.
- `sems.vsc.*`: Define here the VSC codes.

B.1.31 sms

This section provides configuration of **Short Message Service** on the NGCP. Description of the SMS module is provided earlier in this handbook [here](#).

In the below example you can see the default values of the configuration parameters.

```
sms:
  core:
    admin_port: '13000'
    smsbox_port: '13001'
  enable: no
  loglevel: '0'
  sendsms:
```



```

max_parts_per_message: '5'
port: '13002'
smc:
  dest_addr_npi: '1'
  dest_addr_ton: '1'
  enquire_link_interval: '58'
  host: 1.2.3.4
  id: default_smc
  max_pending_submits: '10'
  no_dlr: yes
  password: password
  port: '2775'
  source_addr_npi: '1'
  source_addr_ton: '1'
  system_type: ''
  throughput: '5'
  transceiver_mode: '1'
  username: username

```

- `sms.core.admin_port`: Port number of admin interface of SMS core module (running on LB nodes).
- `sms.core.smsbox_port`: Port number used for internal communication between *bearerbox* module on LB nodes and *smsbox* module on PRX nodes. This is a listening port of the *bearerbox* module (running on LB nodes).
- `sms.enable`: Set to `yes` if you want to enable SMS module.
- `sms.loglevel`: Log level of SMS module; the default `0` will result in writing only the most important information into the log file.
- `sms.sendsms.max_parts_per_message`: If the SM needs to be sent as concatenated SM, this parameter sets the max. number of parts for a single (logical) message.
- `sms.sendsms.port`: Port number of *smsbox* module (running on PRX nodes).
- `sms.smc` : Parameters of the connection to an SMSC
 - `dest_addr_npi`: Telephony numbering plan indicator for the SM destination, as defined by standards (e.g. `1` stands for E.164)
 - `dest_addr_ton`: Type of number for the SM destination, as defined by standards (e.g. `1` stands for "international" format)
 - `enquire_link_interval`: Interval of SMSC link status check in seconds
 - `host`: IP address of the SMSC
 - `id`: An arbitrary string for identification of the SMSC; may be used in log files and for routing SMs.
 - `max_pending_submits`: The maximum number of outstanding (i.e. not acknowledged) SMPP operations between Sipwise C5 and SMSC. As a guideline it is recommended that no more than 10 (default) SMPP messages are outstanding at any time.
 - `no_dlr`: Do not request delivery report; when sending an SM and this parameter is set to `yes`, Sipwise C5 will not request DR for the message(s). May be required for some particular SMSCs, in order to avoid "Incorrect status report request parameter usage" error messages from the SMSC.
 - `password`: This is the password used for authentication on the SMSC.

- port: Port number of the SMSC where Sipwise C5 will connect to.
- source_addr_npi: Telephony numbering plan indicator for the SM source, as defined by standards (e.g. 1 stands for E.164)
- source_addr_ton: Type of number for the SM source, as defined by standards (e.g. 1 stands for "international" format)
- system_type: Defines the SMSC client category in which Sipwise C5 belongs to; defaults to "VMA" (Voice Mail Alert) when no value is given. (No need to set any value)
- throughput: The max. number of messages per second that Sipwise C5 will send towards the SMSC. (Value type: float)
- transceiver_mode: If set to 1 (yes / true), Sipwise C5 will attempt to use a TRANSCEIVER mode connection to the SMSC. It uses the standard transmit port of the SMSC for receiving SMs too.
- username: This is the username used for authentication on the SMSC.

B.1.32 snmpd

The following is the snmpd section:

```
snmpd:
  agentx_timeout: 15
  communities:
    - name: public
      sources:
        - localhost
  trap_communities:
    - name: public
      targets:
        - localhost
  traps:
    if:
      link: yes
    ucd:
      disk: yes
      exec: yes
      load: yes
      process: yes
      swap: yes
```

- `snmpd.agentx_timeout`: Sets the Agent X connection timeout, when communicating with a sub-agent (such as `ngcp-snmp-agent`).
- `snmpd.communities.*`: Sets the SNMP community and sources. Entries (i.e. the `sources`) for a community (like `public` in the example) are in a list of hashes format, each line starting with "-" and followed by the name and a list of source addresses.
- `snmpd.trap_communities.*`: Sets the SNMP TRAP community and destination for traps sent by NGCP. Format is the same as for `snmpd.communities`, but instead of `sources` it uses `targets`.
- `snmpd.traps.if.*`: Enables/disables the emission of SNMP IF MIB traps.
- `snmpd.traps.ucd.*`: Enables/disables the emission of SNMP UCD MIB traps.

B.1.33 snmptrapd

The following is the snmptrapd section:

```
snmptrapd:  
  enable: no
```

- snmptrapd.enable: Enable the snmptrap daemon.

B.1.34 snmpagent

The following is the SNMP Agent section:

```
snmpagent:  
  daemonize: no  
  debug: no  
  retrospect_interval: 30  
  traps:  
    collective_check: yes  
    database: yes  
    ha_switchover: yes  
    peering: yes  
    process: yes  
  traps_origin: mgmt  
  update_interval: '30'
```

- daemonize: Enables/disables ngcp-snmp-agent daemonization.
- debug: Enables/disables debug output.
- retrospect_interval: Sets the interval the agent will use when looking into past fetched data.
- traps.*: Enables/disables emission of SNMP SIPWISE MIB traps.
- traps_origin: Sets the trap emission origin mode. The values can be one of *legacy*, *mgmt* or *distributed*.
- update_interval: Sets the interval in seconds used to update the fetched data.

B.1.35 sshd

The following is the sshd section:

```
sshd:
  listen_addresses:
    - 0.0.0.0
```

- `sshd`: specify interface where SSHD should run on. By default `sshd` listens on all IPs found in `network.yml` with type `ssh_ext`. Unfortunately `sshd` can be limited to IPs only and not to interfaces. The current option makes it possible to specify allowed IPs (or all IPs with `0.0.0.0`).

B.1.36 sudo

The following is in the `sudo` section:

```
sudo:
  logging: no
  max_log_sessions: 0
```

- `logging`: enable/disable the I/O logging feature of `sudo`. See man page of `sudoreplay(8)`.
- `max_log_sessions`: when I/O logging is enabled, specifies how many log sessions per individual user `sudo` should keep before it starts overwriting old ones. The default `0` means no limit.

B.1.37 telegraf

The following is in the `telegraf` section:

```
telegraf:
  interval: ~
```

- `telegraf.interval`: The number of seconds between each data gathering iteration, when the value is undefined, the code will fallback to use `monitoring.interval`.

B.1.38 ngcp-witnessd

The following is the `ngcp-witnessd` tool section:

```
witnessd:
  debug: no
  interval: ~
```

```
gather:
  asr_ner_statistics: yes
  ha_node_force: no
  ha_node_state: yes
  kamailio_concurrent_calls: yes
  kamailio_dialog_active: yes
  kamailio_dialog_early: yes
  kamailio_dialog_incoming: yes
  kamailio_dialog_local: yes
  kamailio_dialog_outgoing: yes
  kamailio_dialog_relay: yes
  kamailio_shmem: yes
  kamailio_usrloc_regdevices: yes
  kamailio_usrloc_regusers: yes
  peering_groups: yes
  mpt_status: no
  mta_queue_len: yes
  mysql_global_status: yes
  mysql_slave_status: yes
  mysql_replicate_check_interval: '3600'
  mysql_replicate_check_tables:
    - accounting
    - billing
    - carrier
    - kamailio
    - ngcp
    - provisioning
    - prosody
    - rtcengine
    - stats
  mysql_replicate_ignore_tables:
    - accounting.acc_backup
    - accounting.acc_trash
    - kamailio.acc_backup
    - kamailio.acc_trash
    - ngcp.pt_checksums_sp1
    - ngcp.pt_checksums_sp2
    - ngcp.pt_checksums
  oss_provisioned_subscribers: yes
  sip_responsiveness: yes
  sip_stats_num_packets: yes
  sip_stats_num_packets_perday: yes
  sip_stats_partition_size: yes
```

- `witnessd.interval`: The number of seconds between each data gathering iteration, when the value is undefined, the code will fallback to use `monitoring.interval`.

- `witnessd.gather.asr_ner_statistics`: Enable ASR/NER statistics data.
- `witnessd.gather.ha_node_force`: Enable data gathering, even if the High-Availavility node status is not active.
- `witnessd.gather.ha_node_status`: Enable High-Availabilty node status data.
- `witnessd.gather.kamailio_*`: Enable Kamailio statistics data.
- `witnessd.gather.mpt_status`: Enable MPT RAID status data.
- `witnessd.gather.mta_queue_len`: Enable MTA (exim4) queue length data.
- `witnessd.gather.mysql_global_status`: Enable global MySQL data.
- `witnessd.gather.mysql_slave_status`: Enable salave (replication) MySQL data.
- `witnessd.gather.mysql_replicate_check_interval`: MySQL replication check interval in seconds.
- `witnessd.gather.mysql_replicate_check_tables`: List of tables that need to be checked for replication issues.
- `witnessd.gather.mysql_replicate_ignore_tables`: List of tables that need to be ignored during replication check.
- `witnessd.gather.oss_provisioned_subscribers`: Enable OSS provisioned subscribers count data.
- `witnessd.gather.sip_*`: Enable SIP statistics data.

B.1.39 `www_admin`

The following is the WEB Admin interface (`www_admin`) section:

```
www_admin:
  ac_dial_prefix: 0
  apache:
    autoprov_port: 1444
  billing_features: 1
  callingcard_features: 0
  callthru_features: 0
  cc_dial_prefix: 00
  conference_features: 1
  contactmail: adjust@example.org
  dashboard:
    enable: 1
  default_admin_settings:
    call_data: 0
    is_active: 1
    is_master: 0
    read_only: 0
    show_passwords: 1
  domain:
    preference_features: 1
```

```
rewrite_features: 1
vsc_features: 0
fastcgi_workers: 2
fax_features: 1
fees_csv:
  element_order:
    - source
    - destination
    - direction
    - zone
    - zone_detail
    - onpeak_init_rate
    - onpeak_init_interval
    - onpeak_follow_rate
    - onpeak_follow_interval
    - offpeak_init_rate
    - offpeak_init_interval
    - offpeak_follow_rate
    - offpeak_follow_interval
    - use_free_time
http_admin:
  autoprov_port: 1444
  port: 1443
  serveradmin: support@sipwise.com
  servername: "\"myserver\""
  ssl_enable: yes
  sslcertfile: '/etc/ngcp-config/ssl/myserver.crt'
  sslcertkeyfile: '/etc/ngcp-config/ssl/myserver.key'
http_csc:
  autoprov_bootstrap_port: 1445
  autoprov_port: 1444
  port: 443
  serveradmin: support@sipwise.com
  servername: "\"myserver\""
  ssl_enable: yes
  sslcertfile: '/etc/ngcp-config/ssl/myserver.crt'
  sslcertkeyfile: '/etc/ngcp-config/ssl/myserver.key'
logging:
  apache:
    acc:
      facility: daemon
      identity: oss
      level: info
    err:
      facility: local7
      level: info
peer:
  preference_features: 1
```

```
peering_features: 1
security:
  password_allow_recovery: 0
  password_max_length: 40
  password_min_length: 6
  password_musthave_digit: 0
  password_musthave_lowercase: 1
  password_musthave_specialchar: 0
  password_musthave_uppercase: 0
  password_sip_autogenerate: 0
  password_sip_expose_subadmin: 1
  password_web_autogenerate: 0
  password_web_expose_subadmin: 1
speed_dial_vsc_presets:
  vsc:
    - '*0'
    - '*1'
    - '*2'
    - '*3'
    - '*4'
    - '*5'
    - '*6'
    - '*7'
    - '*8'
    - '*9'
subscriber:
  auto_allow_cli: 0
  extension_features: 0
voicemail_features: 1
```

- `www_admin.http_admin.*`: Define the Administration interface and certificates.
- `www_admin.http_csc.*`: Define the Customers interface and certificates.
- `www_admin.contactmail`: Email to show in the GUI's Error page.

B.2 constants.yml Overview

`/etc/ngcp-config/constants.yml` is one of the main configuration files that contains important (static) configuration parameters, like Sipwise C5 system-user data.



Caution

Sipwise C5 platform administrator should not change content of `constants.yml` file unless absolutely necessary. Please contact Sipwise Support before changing any of the parameters within the `constants.yml` file!

B.3 network.yml Overview

`/etc/ngcp-config/network.yml` is one of the main configuration files that contains network-related configuration parameters, like IP addresses and roles of the node(s) in Sipwise C5 system.

The next example shows a part of the `network.yml` configuration file. Explanation of all the configuration parameters is provided in [Network Configuration](#) section of the handbook.

Sample host configuration for Sipwise C5

```
self:
  dbnode: '1'
  eth0:
    ip: 10.0.2.15
    netmask: 255.255.255.0
    type:
      - web_ext
      - web_int
      - ssh_ext
  eth1:
    ip: 10.15.20.143
    netmask: 255.255.255.0
    type:
      - ssh_ext
      - web_ext
      - web_int
      - sip_ext
      - rtp_ext
      - mon_ext
  interfaces:
    - lo
    - eth0
    - eth1
  lo:
    cluster_sets:
      - default
    ip: 127.0.0.1
    netmask: 255.255.255.0
    shared_ip: []
    shared_v6ip: []
    type:
      - sip_int
      - ha_int
      - aux_ext
      - ssh_ext
      - api_int
    v6ip: ':::1'
```

```
role:  
  - proxy  
  - lb  
  - mgmt  
  - rtp  
  - db  
status: 'online'
```

C NGCP Internals

This chapter documents internals of Sipwise C5 that should not be usually needed, but might be helpful to understand the overall system.

C.1 Pending reboot marker

The Sipwise C5 has the ability to mark a pending reboot for any server, using the file `/var/run/reboot-required`. As soon as the file exists, several components will report about a pending reboot to the end-user. The following components report about a pending reboot right now: `ngcp-status`, `ngcpcfg status`, `motd`, `ngcp-upgrade`. Also, `ngcp-upgrade` will NOT allow proceeding with an upgrade if it notices a pending reboot. It might affect `rtengine` dkms module building if there is a pending reboot requested by a newly installed kernel, etc.

C.2 Redis id constants

The list of current Sipwise C5 Redis DB IDs:

Service	central (role db)	local	Release	Ticket	Description
sems	-	0	mr3.7.1+	-	HA switchover
rtengine	-	1	mr3.7.1+	-	HA switchover
proxy	2	-	mr3.7.1+	-	Counter of hunting groups
proxy	3	-	mr3.7.1+	-	Concurrent dialog counters
proxy	-	4	mr3.7.1+	-	List of keys of the central counters
prosody	5	-	mr3.7.1+	-	XMPP cluster
sems PBX	-	6	mr3.7.1+	-	HA switchover
sems	7	-	mr4.1.1+	MT#12707	Sems malicious_call app
captagent	-	8	mr4.1.1+ - mr7.1	MT#15427	Old captagent internal data (unused)
monitoring	9	-	mr4.3+ - mr5.5	MT#31	Old SNMP agent monitoring data (unused)
proxy	10	-	mr4.3+	MT#16079	SIP Loop detection
ngcp-panel sessions	-	19	mr6.3+	TT#35523	Panel login sessions
proxy usrloc	20	-	mr6.2+	TT#32971	SIP registrations

Service	central (role db)	local	Release	Ticket	Description
proxy acc	-	21	mr6.2+	TT#32971	Accounting records
proxy auth	-	22	mr6.2+	TT#32971	Subscriber data
proxy dialog	-	23	mr6.2+	TT#34100	Dialog data
websocket	-	30	mr7.1+	TT#49703	Internal data
websocket monitors	-	31	mr7.1+	TT#49703	Monitors
websocket subscriptions	-	32	mr7.1+	TT#49703	Subscriptions

C.2.1 InfluxDB monitoring keys

The *InfluxDB ngcp* monitoring database contains time series of several monitoring sources. The following are some of the current measurements:

node	Cluster node information.
memory	System memory information.
proc_count	Process counts.
monit	Monit supervised processes information.
mail	MTA information.
mysql	MySQL database information.
kamailio	Kamailio statistics information.
sip	SIP statistics information.

The *node* measurement contains the following fields:

active	Cluster node HA state (boolean: 1/0).
hb_proc_state	Cluster node heartbeat process state (boolean: stopped/running).
hb_host_state	Cluster node host state (boolean: up/down).
hb_node_state	Cluster node HA state (ngcp-check-active -p).

The *monit* measurement contains the following fields:

name	The process name.
proc_status	The process status.
monit_status	The monit status.
pid	The process ID.
ppid	The process parent ID.
children	The number of children.
uptime	The process uptime.
cpu_percent	The CPU usage in percent for this process.

cpu_percent_total	The CPU usage in percent for the process group.
memory	The memory in bytes for this process.
memory_total	The memory in bytes for the process group.
memory_percent	The memory in percent for this process.
memory_percent_total	The memory in percent for the process group.
data_collected	The timestamp when the data was collected.

The *mysql* measurement contains the following fields:

last_io_error	Last IO error description.
last_sql_error	Last SQL error description.
queries_per_second_average	Average of queries per second.
replication_discrepancies	Number of replication discrepancies.

C.3 Enum preferences

All tables are in database "provisioning".

So called "enum preferences" allow a fixed set of possible values, an enumeration, for preferences. Following the differences between other preferences are described.

Setting the attribute "data_type" of table "voip_preferences" to "enum" marks a preferences as an enum. The list of possible options is stored in table "voip_preferences_enum".

voip_preferences_enum is:

id

boring pkey

preference_id

Reference to table voip_preferences.

label

A label to be displayed in frontends.

value

Value that will be written to voip_[usr|dom|peer]_preferences.value if it is NOT NULL. Will not be written if it IS NULL. This can be used to implement a "default value" for a preference that is visible

in frontends as such (will be listed first if nothing is actually selected), but will not be written to `voip_[usr|dom|peer]_preferences.value`. Usually forcing a domain or peer default. Should also be named clearly (eg. `__"use domain default"__`). (Note: Therefore will also not be written to any kamailio table.)

`usr_pref`

`dom_pref`

`peer_pref`

Flag if this is to be used for `[usr|dom|peer]` preferences.

`default_val`

Flag indicating if this should be used as a default value when creating new entities or introducing new enum preferences (both done via triggers). (Note: For this to work, value must also be set.)

Relevant triggers:

`enum_update`

Propagates changes of `voip_preferences_enum.value` to `voip_[usr|dom|peer]_preferences.value`

`enum_set_default`

Will create entries for default values when adding a new enum preference. The default value is the tuple from `voip_preferences_enum` WHERE `default_val=1` AND `value NOT NULL`.

`trigger voip_dom_crepl_trig`

`trigger voip_phost_crepl_trig`

`trigger voip_sub_crepl_trig`

These three triggers will set possible default values (same condition as for `enum_set_default`) when creating new subscribers/domains/peers.

Find a usage example in a section in *`db-schema/db_scripts/diff/9086.up`*.

D New kamailio pv_headers module

This chapter documents the new kamailio "pv_headers" modules introduced in Sipwise C5 starting from version mr7.0.1.

D.1 Module overview

This new module enables storing all headers in XAVP to freely modify them in the kamailio logic and only apply them once when it's time for the packet to be routed outside. The main goal of the module is to offload the intermediate header processing into the XAVP dynamic container as well as provide with high level methods and pseudovariables to simplify SIP message header modifications.

In few words:

- as soon as a SIP message enters the proxy, kamailio reads all the headers (using the function "pv_collect_headers()") and stores them in an XAVP called "headers".
- starting from this point all the header changes are directly performed on the "headers" XAVP. For example the From header is available at `$xavp(headers[0]⇒From[0])`.
- right before the SIP message leaves the proxy, kamailio writes back all the headers changes (using the function "pv_apply_headers()").

RURI and the headers listed in the module parameter "skip_headers" are left untouched and not saved in the XAVP. Therefore they should be handled in the usual way.

D.2 Template changes

As described before in the upgrade procedures, the module is enabled by default in kamailio proxy and all the templates have been already updated to use this new logic. Before proceeding with the upgrade, it is essential that the customtt/patchtt files you have in place are updated to this new format.

Here just some few examples of what has been changed in the proxy templates:

- variables \$fu, \$fU, \$fd, \$fn, \$ft have been substituted by \$x_fu, \$x_fU, \$x_fd, \$x_fn, \$x_ft
- variables \$tu, \$tU, \$td, \$tn, \$tt have been substituted by \$x_tu, \$x_tU, \$x_td, \$x_tn, \$x_tt
- variables \$rr, \$rs have been substituted by \$x_rr, \$x_rs
- variables \$ua have been substituted by \$x_hdr(User-Agent)
- variables \$ai have been substituted by \$x_hdr(P-Asserted-Identity)
- variables \$pU, \$pd have been substituted by \$x_hdr(P-Preferred-Identity)
- variables \$re have been substituted by \$x_hdr(Remote-Party-ID)
- variables \$di have been substituted by \$x_hdr(Diversion)

- variables `$ct` have been substituted by `$x_hdr(Contact)`
- `$hdr("name")` has been substituted by `$x_hdr("name")`
- `is_present_hf("name")` has been substituted by `$x_hdr(name)!= $null`
- `remove_hf("name")` has been substituted by `pv_remove_header("name")` function or `$(x_hdr(name)[*]) = $null`
- `append_hf("name: value\r\n")` has been substituted by `pv_append_header("name", "value") / pv_modify_header("name", "value")` functions or `$(x_hdr(name)[*]) = value`
- `t_check_status(code)` has been substituted by `$T_reply_code == code`
- `save("location")` has been updated in `save("location", "0x00", "$x_tu")`
- `sd_lookup("speed_dial")` has been updated in `sd_lookup("speed_dial", $x_fu)`
- added `pv_collect_headers()` and `pv_reset_headers()` functions in the dedicated `ROUTE_COLLECT_HDR` route
- added `pv_apply_headers()` function in the dedicated `ROUTE_APPLY_HDR` route
- added `pv_reset_headers()` function in the following routing sections

D.3 Module documentation

D.3.1 Parameters

xavp_name (string)

Name of the XAVP where the collected headers are stored.

Default: headers

```
modparam("pv_headers", "xavp_name", "headers")
```

Result:

```
$xavp(headers[0]=>From)
$xavp(headers[0]=>To)
$xavp(headers[0]=>Call-ID)
....
```

skip_headers (string)

A comma separated headers list that must be excluded from processing (they are skipped when `pv_apply_headers()` changes the sip message headers). If the parameter is not set then the "Default" list is used. If the parameter is set to an empty string then all the sip message headers are processed.

Default: Record-Route,Via,Route,Content-Length,Max-Forwards

split_headers (string)

A comma separated headers list that must be split into multi headers if their value is a comma separated list. If the parameter is not set then the "Default" is used. If the parameter is set to an empty string then no headers are split.

Default: None

```
modparam("pv_headers", "split_headers", "Diversion")
```

Result:

Received Diversion header:

```
Diversion: <user1@test.local>,<user2@test.local>,<user3@test.local>
```

After split:

```
Diversion: <user1@test.local>
```

```
Diversion: <user2@test.local>
```

```
Diversion: <user3@test.local>
```

Becomes handy `if` used together with `pv_modify_header()` or `pv_remove_header()` to change or remove value 2 `for` instance.

D.3.2 Functions

`pv_collect_headers()`

This function collects all headers from the message into the XAVP. It should be used preferably just when the sip message is received by kamailio.

Returns:

- 1 - on success
- -1 - if there were errors

`pv_apply_headers()`

This function applies the current XAVP headers state to the real headers and should be called only once per branch when the message is about to leave kamailio.

The following rules apply:

- all headers in the XAVP except for ones provided in the "skip_headers" parameter and From/To are recreated in the sip message.
- From/To headers are processed by the uac module if it is loaded.
- From/To headers are not changed in the reply messages.
- headers with NULL value are removed if exist in the sip message.
- the initial order of the sip headers is preserved.

Usage:

```
if (pv_apply_headers ())
{
    "success"
}
else
{
    "errors"
}
```

pv_reset_headers()

This function resets the current XAVP headers list and enables `pv_collect_headers()` and `pv_apply_headers()` to be called again in the same branch.

Usage:

```
if (pv_reset_headers ())
{
    "success"
}
else
{
    "errors"
}
```

pv_check_header(hname)

This function checks if the header already exists in the XAVP. It can be freely called from anywhere, but only after `pv_collect_headers()`.

Usage:

```
if (pv_check_header (hname) )
{
    "exists"
}
else
{
    "does not exist"
}
```

pv_append_header(hname, hvalue)

This function appends a new header into the XAVP. It can be freely called from anywhere, but only after `pv_collect_headers()`.

Please note that subsequent "pv_append_header" calls will result in multiple headers. If the provided "hvalue" is \$null then the header is added into the XAVP but it is not going to be added into the message.

Usage:

```
if (pv_append_header(hname, hvalue))
{
    "appended"
}
else
{
    "errors"
}
```

pv_modify_header(hname, hvalue)

This function modifies an existing header in the XAVP. It can be freely called from anywhere, but only after pv_collect_headers(). Please note that if the header does not exist it will be explicitly appended. If there are multiple headers with the same name only the first one will be affected. If the provided header value is \$null then the header is modified in the XAVP then it is removed from the sip message when pv_apply_headers() is called.

Usage:

```
if (pv_modify_header(hname, hvalue))
{
    "modified"
}
else
{
    "errors"
}
```

pv_modify_header(hname, idx, hvalue)

This function works similar to pv_modify_header(hname, hvalue) but should be used when there are multiple headers with the same name one of them to be modified. Index order is top to bottom.

Usage:

```
if (pv_modify_header(hname, idx, hvalue))
{
    "modified"
}
else
{
```

```
"errors"  
}
```

pv_remove_header(hname)

This function removes an existing header from the XAVP. It can be freely called from anywhere, but only after pv_collect_headers(). If there are multiple headers with the same name all of them are removed. It returns -1 if the header does not exist.

Usage:

```
if (pv_remove_header(hname, hvalue))  
{  
    "removed"  
}  
else  
{  
    "does not exist or errors"  
}
```

pv_remove_header(hname, idx, hvalue)

This function works similar to pv_remove_header(hname, hvalue) but should be used when there are multiple headers with the same name one of them to be removed. Index order is top to bottom.

Usage:

```
if (pv_remove_header(hname, idx, hvalue))  
{  
    "removed"  
}  
else  
{  
    "does not exist or errors"  
}
```

D.3.3 Pseudovariabes

\$x_hdr

This pseudovariabes is used to append/modify/remove headers by their name and can be used instead of the pv_append_header(), pv_modify_header(), pv_remove_header() functions.

Usage:

- append header "X-Header" with value "example". NOTE: It always appends a header, even there is already one with the same

name

```
$x_hdr(X-Header) = "example";
```

- modify header "X-Header" with index 0. Returns an error if there is no such index

```
$(x_hdr(X-Header)[0]) = "example";
```

- remove all occurrences of header "X-Header" and append one with value "example"

```
$(x_hdr(X-Header)[*]) = "example";
```

- remove header "X-Header" with index 2 (if there are multiple headers). Returns an error if there is no such index

```
$(x_hdr(X-Header)[2]) = $null;
```

- remove all occurrences of the header. Does not produce an error if there is no such header

```
$(x_hdr(X-Header)[*]) = $null;
```

- retrieve a value of header "X-Header" with index 0, otherwise \$null

```
$var(test) = $x_hdr(X-Header);
```

- retrieve a value of header "X-Header" with index 0 otherwise \$null

```
$var(test) = $x_hdr(X-Header)[*];
```

- retrieve a value of header "X-Header" with index 2 otherwise \$null

```
$var(test) = $(x_hdr(X-Header) [2]);
```

\$x_fu, \$x_tu

These pseudovariables are used to modify/retrieve the "From" and "To" headers.

Usage:

- modify the header

```
$x_fu = "User1 <440001@example.local>";
```

- retrieve a value of the header

```
$var(test) = $x_fu;
```

- \$x_tu usage is the same

\$x_fU, \$x_tU

These pseudovariables are used to modify/retrieve the username part of the "From" and "To" headers.

Usage:

- modify the username part

```
$x_fU = "440001";
```

- retrieve the username part

```
$var(test) = $x_fU;
```

- \$x_tU usage is the same

\$x_fd, \$x_td

These pseudovariabes are used to modify/retrieve the domain part of the "From" and "To" headers.

Usage:

- modify the domain part

```
$x_fd = "example.local";
```

- retrieve the domain part

```
$var(test) = $x_fd;
```

- \$x_td usage is the same

\$x_fn, \$x_tn

These pseudovariabes are used to modify/retrieve the display part of the "From" and "To" headers.

Usage:

- modify the username part

```
$x_fn = "User1";
```

- retrieve the domain part

```
$var(test) = $x_fn;
```

- \$x_tn usage is the same

\$x_ft, \$x_tt

These pseudovariabes are used to retrieve the tag part of the "From" and "To" headers.

Usage:

- retrieve the tag part

```
$var(test) = $x_ft;
```

- \$x_tt usage is the same

\$x_rs, \$x_rr

These pseudovariables are used to modify/retrieve or change "status" and "code" of the SIP reply NOTE: Only messages with reply status > 300 can be changed as well as reply status 1xx and 2xx cannot be set

Usage:

- modify the reply status

```
$x_rs = 486
```

- retrieve the reply status

```
$var(test) = $x_rs;
```

- modify the reply reason

```
$x_rr = "Custom Reason"
```

- retrieve the reply reason

```
$var(test) = $x_rr;
```

E Extra Configuration Scenarios

E.1 AudioCodes devices workaround

Old AudioCodes devices suffer from a problem where they replace `127.0.0.1` address in Record-Route headers (added by Sipwise C5's internal components) with the device's IP address. Supposedly, the whole range of AudioCodes devices with a firmware version below 6.8.X are affected. As a workaround, you may enable the `topos` feature to stop sending Record-Route headers out. To achieve this, execute the following commands:

```
ngcpcfg set /etc/ngcp-config/config.yml kamailio.lb.security.topos.enable=yes
ngcpcfg apply 'enable topos for audiocodes devs workaround'
```